

THE INFLUENCE OF MUSCLE FIBRE RECRUITMENT ON $\dot{V}O_2$ KINETICS

Fred J. DiMenna

Submitted by Fred J. DiMenna to the University of Exeter as a thesis for the
degree of Doctor of Philosophy by Research in Sport and Health Sciences

March 2010

This thesis is available for Library use on the understanding that it is copyright
material and that no quotation from the thesis may be published without
proper acknowledgement.

I certify that all material in this thesis which is not my own work has been
identified and that no material has previously been submitted and approved for
the award of a degree by this or any other University.

Fred J DiMenna

.....

Abstract

When O₂ uptake at the lung is used to characterise the oxidative metabolic response to increased contractile activity (\dot{V}_{O_2} kinetics) in exercising muscle, the \dot{V}_{O_2} profile reflects the combined influence of all involved muscle fibres. Consequently, during high-intensity exercise that mandates activation of fibres with considerable metabolic diversity (e.g., both principal fibre types), response characteristics specific to discrete segments of the recruited pool cannot be determined. The purpose of this thesis was to identify fibre-type-specific effects of conditions that might impact O₂ delivery and/or motor unit recruitment patterns on \dot{V}_{O_2} kinetics by using two models that increase fibre recruitment homogeneity during exercise transitions. In four experiments, subjects initiated high-intensity exercise from a moderate baseline (i.e., performed ‘work-to-work’ transitions; M→H) to target higher-order fibres, and in two experiments, subjects cycled at extremely slow and fast pedal rates to skew recruitment toward slow- and fast-twitch fibres, respectively. At mid-range contraction frequency, \dot{V}_{O_2} kinetics (as indicated by the primary time constant, τ_p) was slower for M→H compared to unloaded-to-high-intensity transitions (U→H) (e.g., 42 v. 33 s; Ch 4) and this slowing was ~50% greater for M→H in a supine body position (decreased oxygenation; Ch 6). Slower kinetics was also present for U→H cycling at fast compared to slow pedal rates (τ_p , 48 v. 31 s; Ch 8). Conversely, M→H slowing relative to U→H was absent at extreme cadences (36 v. 31 s and 53 v. 48 s for slow and fast, respectively; Ch 7). After ‘priming’ (increased oxygenation), τ_p was reduced for U→H after fast-cadence priming only (Ch 8) and for M→H in the supine position (Ch 6), but unaffected for upright cycle and prone knee-extension M→H, for which priming reduced the \dot{V}_{O_2} slow component and delayed-onset fibre activation (as indicated by iEMG; Chs 4 and 5). These results provide evidence in exercising humans that high-order fibres possess innately slow \dot{V}_{O_2} kinetics and are acutely susceptible to interventions that might alter O₂ delivery to muscle.

Table of contents

Abstract	i
Table of contents	ii
List of tables	vii
List of figures	ix
Symbols and abbreviations	xiii
Declaration, communications and publications	xvi
Acknowledgements	xix

Chapter 1 Introduction

Bioenergetics in the human machine	1
O ₂ delivery to and utilisation in skeletal muscle fibres.....	2
O ₂ uptake kinetics	3
Measuring O ₂ uptake.....	4
Muscle fibre-type heterogeneity	5
Influence of muscle fibre recruitment on $\dot{V}O_2$ kinetics.....	6

Chapter 2 Review of literature

The history of oxygen uptake kinetics	8
Discovery of O ₂ and its role in cellular respiration.....	8
Analysis of human gas exchange	8
The Douglas bag method of gas exchange analysis.....	9
Gas exchange analysis in the non-steady state.....	10
The dynamic $\dot{V}O_2$ response to exercise	14
Implications for metabolic control.....	14
Breath-by-breath gas exchange measurement technology.....	15
Linear first-order oxidative control.....	15
Oxidative system nonlinearity: the $\dot{V}O_2$ slow component	16
The three-phase $\dot{V}O_2$ response at exercise onset.....	17
The cardiodynamic phase.....	18
The $\dot{V}O_2$ slow component and critical power	19
$\dot{V}O_2$ as a proxy for muscle O ₂ uptake	20
O ₂ uptake kinetics: a coming of age.....	22
Characterising the $\dot{V}O_2$ response at exercise onset	23
Accounting for phase I.....	23
Characterising phase II.....	24
Characterising the $\dot{V}O_2$ slow component	25
The lactate/gas exchange threshold.....	28
Exercise intensity domains.....	29
Oxidative control system analysis	32
Boltzmann's principle of superposition	32

Work-to-work exercise transitions – early findings.....	33
Nonlinear behaviour in oxidative control	37
Mechanistic bases for nonlinear behaviour in oxidative control	37
Potential determinants of oxidative control	40
Oxidative control by convective/diffusive O ₂ conductance.....	40
Control of oxidative function by O ₂ availability.....	42
Increasing O ₂ availability: the prior exercise effect.....	44
The role of O ₂ under ‘normal’ condtions	49
Control of oxidative function by intracellular processes	51
Intracellular control – redox potential.....	51
Intracellular control – phosphorylation potential.....	52
The creatine phosphate shuttle.....	52
The electrical analogue model of respiratory control	54
The work-to-work exercise effect	57
Work-to-work exercise transitions revisited	57
Work-to work effect: implications for metabolic control	61
Muscle fibre type and motor unit activation	62
Characteristics of muscle fibre types: <i>in-vitro</i> investigations.....	62
Work-to-work exercise and fibre-type specificity	65
Work-to-work exercise and O ₂ availability	66
Supra-GET work-to-work exercise	70
The intracellular work-to-work exercise effect.....	74
Influence of muscle fibre type on $\dot{V}O_2$ kinetics	76
Fibre-type influence in exercising humans <i>in vivo</i>	76
Intervention-induced alteration of fibre-type activation	76
Fibre-type activation – exercise intensity dependence	80
Muscle fibre type, motor unit recruitment and the $\dot{V}O_2$ slow component ...	83
Delayed-onset motor unit activation and the $\dot{V}O_2$ slow component	86
Oxidative system nonlinearity or linear diversity?	99
Summary	100
Aims	100
Hypotheses.....	101

Chapter 3 General methods

General experimental procedures	102
Subjects	102
Informed consent.....	102
Health and safety.....	103
Measurement procedures.....	103
Descriptive data.....	103
Pulmonary gas exchange.....	104
Electromyography.....	104
Heart rate.....	105
³¹ P phosphorous magnetic resonance spectroscopy.....	105
Near-infrared spectroscopy.....	106
Blood lactate concentration.....	107
Testing procedures.....	107

Preliminary exercise testing	107
Determination of $\dot{V}O_{2peak}$ and gas exchange threshold	109
Experimental exercise testing	109
Calculation of work rates for constant-load tests	110
Gas exchange data analysis procedures	110
Enhancing signal-to-noise ratio	110
Mathematical modelling of $\dot{V}O_2$ data	114
Other data analysis procedures	115
Filtering and averaging of electromyographic data	115
Mathematical modelling of heart rate data	116
Peak fitting of 31 phosphorous magnetic resonance spectra	116
Mathematical modelling of phosphocreatine concentration data	117
Mathematical modelling of deoxyhaemoglobin concentration data	117
Analysis of oxyhaemoglobin concentration data	118
Statistical methods	118

EXPERIMENTAL CHAPTERS

Chapter 4	Influence of priming exercise on pulmonary O_2 uptake kinetics during transitions to high-intensity exercise from an elevated baseline	
	Introduction	119
	Methods	120
	Results	121
	Discussion	122
	References	126
Chapter 5	Influence of priming exercise on muscle [PCr] and pulmonary O_2 uptake dynamics during "work-to-work" knee-extension exercise	
	Introduction	128
	Methods	129
	Results	131
	Discussion	133
	References	137
Chapter 6	Priming exercise speeds pulmonary O_2 uptake kinetics during supine "work-to-work" high-intensity cycle exercise	
	Introduction	140
	Methods	141
	Results	143
	Discussion	146
	References	148

Chapter 7 Influence of extreme pedal rates on pulmonary O₂ uptake kinetics during transitions to high-intensity exercise from an elevated baseline

Introduction	150
Methods	151
Results	153
Discussion	155
References	156

Chapter 8 Influence of priming exercise on pulmonary O₂ uptake kinetics during transitions to high-intensity exercise at extreme pedal rates

Introduction	158
Methods	159
Results	160
Discussion	162
References	167

Chapter 9 General discussion

Justification of the work-to-work model for assessing fibre-type diversity	169
Work-to-work effect: elevated baseline heart rate	170
Work-to-work effect: elevated baseline metabolic rate (\dot{V}_{O_2})	173
Work-to-work effect: elevated baseline work rate	175
Work-to-work effect: at extreme pedal cadences	178
Key findings from experimental chapters	180
Muscle fibre type and O ₂ availability	180
The fibre-type-specific tipping point	181
Muscle fibre type and metabolic inertia	185
Fibre-type-specific metabolic inertia: directions for future research	187
Motor unit activation and the \dot{V}_{O_2} slow component	189
Does iEMG change with time during high-intensity exercise?	190
Are priming-induced changes in \dot{V}_{O_2} kinetics reflected in altered iEMG? ..	193
\dot{V}_{O_2} slow component: delayed-onset fibre activation	194
\dot{V}_{O_2} slow component: reduced efficiency in initially-active fibres	196
\dot{V}_{O_2} slow component: response heterogeneity in initially-active fibres	196
\dot{V}_{O_2} slow component: directions for future research	204
Limitations to the present research	207
Confidence in modelled \dot{V}_{O_2} kinetics parameter estimates	207
Use of electromyographic data to infer motor unit activation	208
Use of near-infrared spectroscopy data to infer muscle O ₂ extraction	209
Conclusions	211
Hypothetical model: fibre-type diversity and \dot{V}_{O_2} kinetics	211
Hypothetical construct 1: \dot{V}_{O_2} response to moderate-intensity exercise	213
Hypothetical construct 2: \dot{V}_{O_2} response to heavy-intensity exercise	213

Hypothetical construct 3: $\dot{V}O_2$ response to severe-intensity exercise.....	215
Hypothetical construct 4: $\dot{V}O_2$ response to work-to-work exercise.....	217
Hypothetical constructs 1-4: summary	217
Hypothetical model: intervention-induced alterations in $\dot{V}O_2$ kinetics	219
Hypothetical construct 5: $\dot{V}O_2$ response to primed exercise.....	220
Hypothetical construct 6: $\dot{V}O_2$ response to supine exercise.....	222
Hypothetical construct 7: τ_p relationship for U→M, U→H and M→H	224
Summary	227
References	229

*List of tables***Chapter 2 Review of literature**

Table 2.1	Summary of findings from investigations that explored the effect of altering motor unit activation by fibre-type specific selective glycogen depletion or neuromuscular blockade	78
Table 2.2	Summary of findings from investigations that explored the effect of altering motor unit activation by manipulating pedal cadence	81
Table 2.3	Summary of findings from investigations that involved assessment of fibre activation by electromyography (integrated electromyogram or root mean square and/or mean or median power frequency) and O ₂ uptake during constant-load exercise	88
Table 2.4	Summary of findings from investigations that involved assessment of fibre activation by magnetic resonance imaging (T2) and O ₂ uptake during constant-load exercise	94

Chapter 3 General methods

Table 3.1	The effect of removing outliers and averaging like transitions on parameter estimates derived from exponential curve fitting of $\dot{V}O_2$ data and associated 95% confidence intervals	113
-----------	---	-----

Chapter 4 Influence of priming exercise on pulmonary O₂ uptake kinetics during transitions to high-intensity exercise from an elevated baseline

Table 1	Mean (\pm SD) heart rate kinetics during U \rightarrow S, M \rightarrow S Unprimed and M \rightarrow S Primed exercise	122
Table 2	Mean (\pm SD) $\dot{V}O_2$ kinetics during U \rightarrow S, M \rightarrow S Unprimed and M \rightarrow S Primed exercise	123

Chapter 5 Influence of priming exercise on muscle [PCr] and pulmonary O₂ uptake dynamics during "work-to-work" knee-extension exercise

Table 1	Mean (\pm SD) O ₂ uptake kinetics during unprimed and primed rest-to-moderate-intensity exercise transitions	132
Table 2	Mean (\pm SD) [PCr] dynamics during unprimed and primed rest-to-moderate-intensity exercise transitions	132
Table 3	Mean (\pm SD) O ₂ uptake kinetics during unprimed and primed work-to-work high-intensity exercise transitions	133
Table 4	Mean (\pm SD) [PCr] dynamics during unprimed and primed work-to-work high-intensity exercise transitions	133

Chapter 6	Priming exercise speeds pulmonary O₂ uptake kinetics during supine "work-to-work" high-intensity cycle exercise	
Table 1	Mean (\pm SD) O ₂ uptake kinetics during moderate upright, moderate supine unprimed and moderate supine primed cycling	144
Table 2	Mean (\pm SD) blood [lactate], heart rate dynamics and deoxyhaemoglobin kinetics during moderate upright, moderate supine unprimed and moderate supine primed cycling	144
Table 3	Mean (\pm SD) O ₂ uptake kinetics during work-to-work severe upright, supine unprimed and supine primed cycling	145
Table 4	Mean (\pm SD) blood [lactate], heart rate dynamics and deoxyhaemoglobin kinetics during work-to-work severe upright, supine unprimed and supine primed cycling	145
Chapter 7	Influence of extreme pedal rates on pulmonary O₂ uptake kinetics during transitions to high-intensity exercise from an elevated baseline	
Table 1	Mean (\pm SD) O ₂ uptake kinetics and blood [lactate] during U \rightarrow M ₃₅ , U \rightarrow H ₃₅ and M \rightarrow H ₃₅ exercise	153
Table 2	Mean (\pm SD) O ₂ uptake kinetics and blood [lactate] during U \rightarrow M ₁₁₅ , U \rightarrow H ₁₁₅ and M \rightarrow H ₁₁₅ exercise	154
Chapter 8	Influence of priming exercise on pulmonary O₂ uptake kinetics during transitions to high-intensity exercise at extreme pedal rates	
Table 1	Mean (\pm SD) blood [lactate] and heart rate and oxyhaemoglobin and deoxyhaemoglobin kinetics during 35 Unprimed, 35 \rightarrow 35 and 115 \rightarrow 35	161
Table 2	Mean (\pm SD) blood [lactate] and heart rate and oxyhaemoglobin and deoxyhaemoglobin kinetics during 115 Unprimed, 35 \rightarrow 115 and 115 \rightarrow 115	162
Table 3	O ₂ uptake kinetics during 35 Unprimed, 35 \rightarrow 35 and 115 \rightarrow 35	162
Table 4	O ₂ uptake kinetics during 115 Unprimed, 35 \rightarrow 115 and 115 \rightarrow 115	163
Chapter 9	General discussion	
Table 9.1	Individual subject data from pilot testing that confirmed the absence of characteristic work-to-work τ_p lengthening during transitions to high-intensity exercise from unloaded cycling with an elevated baseline metabolic rate (\dot{V}_{O_2})	176
Table 9.2	Phase II τ values for U \rightarrow M and M \rightarrow H cycling and knee-extension exercise transitions at different contraction frequencies.....	179

*List of figures***Chapter 1 Introduction**

- Figure 1.1 Graphic representation of the exponential rise in oxygen uptake in response to a step increase in muscular work 4

Chapter 2 Review of literature

- Figure 2.1 Graphic representations of the difference between fitting supra-GET-intensity exercise with a single exponential that includes or excludes the \dot{V}_{O_2} slow component 27
- Figure 2.2 Two schemata typically used to quantify exercise intensity relative to metabolic capacity 29
- Figure 2.3 Graphic illustration of \dot{V}_{O_2} time course parameter estimates for full and work-to-work cycle ergometer transitions adapted from Hughson and Morrissey (1982) 36
- Figure 2.4 Schematic illustration of an input/output system comprising three reactants with differing capacities to respond 39
- Figure 2.5 The characteristic effect of prior high-intensity 'priming' exercise on \dot{V}_{O_2} kinetics 47
- Figure 2.6 Illustration of the 'tipping point' theory that has been advanced to explain the degree of influence O_2 availability plays in setting the phase II \dot{V}_{O_2} time course 50
- Figure 2.7 The analogue model of respiratory control proposed by Meyer 55
- Figure 2.8 A hypothetical model depicting the effect of muscle fibre type on \dot{V}_{O_2} kinetics during exercise transitions in the lower and upper region of the moderate-intensity domain 67
- Figure 2.9 Time constant values for \dot{V}_{O_2} , HR and leg blood flow, and MRT for HHb during full moderate transitions and work-to-work transitions in the upper and lower moderate regions adapted from MacPhee *et al.* (2005) 69
- Figure 2.10 Time constant values for \dot{V}_{O_2} and HR during moderate, full heavy and work-to-work heavy transitions adapted from Wilkerson and Jones (2007) 73
- Figure 2.11 A hypothetical model depicting the possible influence of the recruitment of muscle fibres with different metabolic response profiles on the \dot{V}_{O_2} response to moderate, heavy and severe exercise 98

Chapter 3	General methods	
Figure 3.1	Graphic illustration of how conservative editing of definitive outliers and ensemble averaging of like transitions are two ways to improve confidence in parameter estimates derived from mathematical modelling of $\dot{V}O_2$ data	111
Chapter 4	Influence of priming exercise on pulmonary O_2 uptake kinetics during transitions to high-intensity exercise from an elevated baseline	
Figure 1	Schematic illustration of the experimental protocol	120
Figure 2	Heart rate response at 30-second intervals during baseline cycling and severe exercise	123
Figure 3	Pulmonary O_2 uptake response following the onset of severe exercise in a representative subject	124
Figure 4	Group mean $\dot{V}O_2$ response following the onset of severe exercise where $\dot{V}O_2$ is expressed per unit change in work rate	124
Figure 5	Group mean integrated electromyogram response during severe exercise.....	125
Chapter 5	Influence of priming exercise on muscle [PCr] and pulmonary O_2 uptake dynamics during "work-to-work" knee-extension exercise	
Figure 1	Group mean pulmonary $\dot{V}O_2$ response and intramuscular [PCr] hydrolysis response during R→M/M→H exercise transitions	132
Figure 2	Group mean (\pm SD) $\dot{V}O_2$ and [PCr] slow component relative response amplitudes during M→H exercise in the unprimed and primed states ..	133
Figure 3	Group mean (\pm SD) intramuscular pH responses at 60-second intervals during R→M/M→H exercise transitions	134
Figure 4	Group mean (\pm SD) integrated electromyogram responses for minute 1 and minute 6 during R→M and M→H exercise transitions in the unprimed and primed states	135
Figure 5	Group mean (\pm SD) $\Delta\dot{V}O_2/\Delta iEMG$ responses at 60-second intervals during R→M/M→H exercise transitions	136
Chapter 6	Priming exercise speeds pulmonary O_2 uptake kinetics during supine "work-to-work" high-intensity cycle exercise	
Figure 1	Schematic illustration of the four experimental protocols	141
Figure 2	Pulmonary O_2 uptake response following the onset of moderate-intensity cycling in a representative subject	143
Figure 3	Group mean $\Delta[HHb]/\Delta\dot{V}O_2$ during moderate-intensity and work-to-work severe-intensity cycling transitions	144

Figure 4	Pulmonary O ₂ uptake response following the onset of work-to-work cycling in a representative subject	144
Figure 5	Group mean (\pm SD) total haemoglobin concentration at 60-second intervals during moderate and work-to-work supine cycling in the unprimed and primed states	145
Figure 6	Group mean (\pm SD) iEMG response during moderate and work-to-work severe unprimed and primed supine cycling	146
Chapter 7	Influence of extreme pedal rates on pulmonary O₂ uptake kinetics during transitions to high-intensity exercise from an elevated baseline	
Figure 1	Schematic illustration of the two experimental protocols	151
Figure 2	Group mean primary \dot{V}_{O_2} response following the onset of exercise at each pedal rate where \dot{V}_{O_2} is expressed relative to the amplitude of the primary response	153
Figure 3	Summed mean iEMG response throughout U \rightarrow H and U \rightarrow M/ M \rightarrow H at 35 and 115 rev \cdot min ⁻¹ for a representative subject	154
Figure 4	Group mean (\pm SD) phase II \dot{V}_{O_2} τ for U \rightarrow M, U \rightarrow H and M \rightarrow H at each pedal rate	155
Chapter 8	Influence of priming exercise on pulmonary O₂ uptake kinetics during transitions to high-intensity exercise at extreme pedal rates	
Figure 1	Pulmonary O ₂ uptake response after the onset of exercise during unprimed cycling at 35 and 115 rev \cdot min ⁻¹ in a representative subject ...	161
Figure 2	Group mean total haemoglobin concentration, oxyhaemoglobin concentration and deoxyhaemoglobin concentration responses during baseline cycling and following the onset of exercise at 35 and 115 rev \cdot min ⁻¹	164
Figure 3	Group mean pulmonary O ₂ uptake response after the onset of exercise during unprimed and primed cycling at 35 and 115 rev \cdot min ⁻¹	165
Chapter 9	General discussion	
Figure 9.1	Group mean \dot{V}_{O_2} responses for U \rightarrow H, E \rightarrow H (elevated \dot{V}_{O_2} without elevated work rate) and M \rightarrow H transitions from pilot testing done in conjunction with the experiments conducted for this thesis	177
Figure 9.2	Illustration of a modified version of the tipping point theory that demarcates a fibre-type-specific degree of influence that O ₂ availability plays in setting the phase II \dot{V}_{O_2} time course	182
Figure 9.3	A schematic illustration from Brittain <i>et al.</i> (2001) that illustrates how a ten-compartment model can present a response profile that is functionally indistinguishable from a monoexponential curve	198

Figure 9.4	Hypothetical model depicting the full pool of muscle fibres available for recruitment in a prime mover muscle during cycle ergometer exercise and associated oxidative response profiles	212
Figure 9.5	Hypothetical model depicting the pool of muscle fibres recruited in a prime mover muscle during cycle ergometer moderate-intensity exercise and associated oxidative response profile.....	214
Figure 9.6	Hypothetical model depicting the pool of muscle fibres recruited in a prime mover muscle during cycle ergometer heavy-intensity exercise and associated oxidative response profile	215
Figure 9.7	Hypothetical model depicting the pool of muscle fibres recruited in a prime mover muscle during cycle ergometer severe-intensity exercise and associated oxidative response profile	216
Figure 9.8	Hypothetical model depicting the pool of muscle fibres recruited in a prime mover muscle during cycle ergometer severe-intensity exercise initiated from a moderate-intensity baseline and associated oxidative response profile	218
Figure 9.9	Summary of the hypothetical model and constructs 1 - 4	219
Figure 9.10	Hypothetical model depicting how an accelerated \dot{V}_{O_2} response in higher-order fibres might exclusively explain the characteristic prior-exercise effect during severe-intensity exercise transitions	221
Figure 9.11	Hypothetical model depicting how altered fibre recruitment might exclusively explain the characteristic prior-exercise effect during severe-intensity exercise transitions	222
Figure 9.12	Hypothetical model depicting the effect of a supine body posture on \dot{V}_{O_2} kinetics during severe-intensity cycling based upon the assumption that only type II fibres are susceptible to reduced perfusion pressure	223
Figure 9.13	Individual subject phase II τ values for lower, full and upper cycle transitions from Brittain <i>et al.</i> (2001) and Wilkerson and Jones (2006).....	225
Figure 9.14	Hypothesised effect of extreme pedal rates on the phase II \dot{V}_{O_2} τ during U→M, U→H and M→H cycle ergometer transitions	226

Symbols and abbreviations

$[x]$	concentration of x (e.g., [blood] lactate, [PCr])
Δx	difference or temporal change in x (e.g., Δ blood (lactate))
$([ATP]/[ADP] \times [P_i])$	phosphorylation potential
$[NADH]/[NAD^+]$	redox potential
ΔG_{ATP}	Gibbs free energy of cytosolic ATP hydrolysis
$\Delta[HHb]/\Delta\dot{V}_{O_2}$	index of O_2 extraction per \dot{V}_{O_2} increment
$\Delta\dot{V}_{O_2(6-2)}$	difference in \dot{V}_{O_2} between min two and six (approximates \dot{V}_{O_2} SC)
% Δ	% difference between GET and \dot{V}_{O_2max}
subscript p	phase II or primary response parameter (e.g., τ_p , A_p , TD_p , G_p)
^{31}P -MRS	31 phosphorous nuclear magnetic resonance spectroscopy
A	exponential response amplitude
ADP	adenosine diphosphate
ATP	adenosine triphosphate
a-v O_2 diff	difference between arterial and mixed venous O_2 content
Ca $^{2+}$	calcium
CI	confidence interval (e.g., 95% CI; CI $_{95}$)
CO $_2$	carbon dioxide
CP	critical power (i.e., asymptote of the power/time hyperbola)
dx/dt	change in x per time (A/τ for an exponential response)
EMG	electromyogram
G	functional system gain
GET	gas exchange threshold
Hb	haemoglobin

HHb	deoxygenated haemoglobin
HR	heart rate
iEMG	integrated electromyogram ($\mu\text{V}\cdot\text{s}$)
LT	lactate threshold
M→H	moderate- to high-intensity ('work-to-work') exercise transition
M→S	M→H (Chapter 4)
Mb	myoglobin
MPF	mean/median power frequency of the EMG
MRI	magnetic resonance imaging
MRT	mean response time (approximated by $\tau + \text{TD}$ of an exponential)
MVC	maximal voluntary contraction
NAD	nicotinamide adenine dinucleotide
NADH	nicotinamide adenine dinucleotide reduced
NIRS	near-infrared spectroscopy
NO	nitric oxide
O ₂	oxygen
PCr	phosphocreatine (or creatine phosphate)
PDC	pyruvate dehydrogenase complex
P _i	inorganic phosphate
PmvO ₂	microvascular O ₂ pressure
PO ₂	partial pressure of O ₂
R→M	transition from rest to moderate-intensity exercise
RCT	respiratory compensation threshold
RMS	root mean square of the EMG
SC	slow component

τ	time constant (time to reach 63% of an exponential response)
TD	exponential response time delay
U→H	transition from unloaded cycling to high-intensity exercise
U→M	transition from unloaded cycling to moderate-intensity exercise
U→S	U→H (Chapter 4)
\dot{V}_{CO_2}	carbon dioxide output
\dot{V}_{E}	pulmonary ventilation (expired)
\dot{V}_{O_2}	pulmonary oxygen uptake
$\dot{V}_{\text{O}_2} \text{ G}$	($\Delta\dot{V}_{\text{O}_2}/\Delta\text{work rate}$; i.e., inverse of Δ efficiency)
$\dot{V}_{\text{O}_{2\text{max}}}$	maximum oxygen uptake
W	watt
WR	work rate

Declaration

The material contained within this thesis is original work conducted and written by the author. The following communications and publications are a direct consequence of this work.

Publications

- DiMenna, F.J., Fulford, J., Bailey, S.J., Vanhatalo, A., Wilkerson, D.P. and Jones, A.M. (2010). Influence of priming exercise on muscle [PCr] and pulmonary O₂ uptake dynamics during "work-to-work" knee-extension exercise. *Respiratory Physiology and Neurobiology*, **172**, 15-23.
- DiMenna, F.J. and Jones, A.M. (2009). "Linear" versus "Nonlinear" $\dot{V}O_2$ responses to exercise: reshaping traditional beliefs. *Journal of Exercise Science and Fitness*, **7**, 67-84.
- DiMenna, F.J., Wilkerson, D.P., Burnley, M., Bailey, S.J. and Jones, A.M. (2009). Influence of priming exercise on pulmonary O₂ uptake kinetics during transitions to high-intensity exercise at extreme pedal rates. *Journal of Applied Physiology*, **106**, 432-442.
- DiMenna, F.J., Wilkerson, D.P., Burnley, M., Bailey, S.J. and Jones, A.M. (2009). Influence of extreme pedal rates on pulmonary O₂ uptake kinetics during transitions to high-intensity exercise from an elevated baseline. *Respiratory Physiology and Neurobiology*, **169**, 16-23.
- DiMenna, F.J., Wilkerson, D.P., Burnley, M., Bailey, S.J. and Jones, A.M. (2010). Priming exercise speeds pulmonary O₂ uptake kinetics during supine "work-to-work" high-intensity cycle exercise. *Journal of Applied Physiology*, **108**, 283-292.
- DiMenna, F.J., Wilkerson, D.P., Burnley, M. and Jones, A.M. (2008). Influence of priming exercise on pulmonary O₂ uptake kinetics during transitions to high-intensity exercise from an elevated baseline. *Journal of Applied Physiology*, **105**, 538-546.

Conference communications

- DiMenna, F., Thompson, K.G., Lothian, F., Taylor, E., Garland, S.W., Hayes, P. and Jones, A.M. (2007). Prior high-intensity exercise does not speed VO₂ kinetics during subsequent high-intensity exercise during treadmill running. *BASES, Bath*.
- DiMenna, F.J., Wilkerson, D.P., Burnley, M., Bailey, S.J. and Jones, A.M. (2009). Influence of priming exercise on pulmonary O₂ uptake kinetics during transitions to high-intensity exercise at extreme pedal rates. *BASES, Leeds*
- DiMenna, F., Wilkerson, D., Burnley, M. and Jones, A.M. (2008). Influence of priming exercise on pulmonary O₂ uptake kinetics during transitions to high-intensity exercise from an elevated baseline. *ECSS, Estorvil*.

Other publications

- Bailey, S.J., Vanhatalo, A., Wilkerson, D.P., DiMenna, F.J. and Jones, A.M. (2009). Optimizing the “priming” effect: influence of prior exercise intensity and recovery duration on O₂ uptake kinetics and severe-intensity exercise tolerance. *Journal of Applied Physiology*, **107**, 1743-1756.
- Bailey, S.J., Wilkerson, D.P., DiMenna, F.J. and Jones, A.M. (2009). Influence of repeated sprint training on pulmonary O₂ uptake and muscle deoxygenation kinetics in humans. *Journal of Applied Physiology*, **106**, 1875-1887.
- Bailey, S.J., Winyard, P., Vanhatalo, A., Blackwell, J.R., DiMenna, F.J., Wilkerson, D.P., Tarr, J., Benjamin, N. and Jones, A.M. (2009). Dietary nitrate supplementation reduces the O₂ cost of low-intensity exercise and enhances tolerance to high-intensity exercise in humans. *Journal of Applied Physiology*, **107**, 1144-1155.
- Davies, R.C., Eston, R.G., Poole, D.C., Rowlands, A.V., DiMenna, F., Wilkerson, D.P., Twist, C. and Jones, A.M. (2008) Effect of eccentric exercise-induced muscle damage on the dynamics of muscle oxygenation and pulmonary oxygen uptake. *Journal of Applied Physiology*, **105**, 1413-1421.
- Jones, A.M., DiMenna, F., Lothian, F., Taylor, E., Garland, S.W., Hayes, P.R. and Thompson, K.G. (2008) ‘Priming’ exercise and O₂ uptake kinetics during treadmill running. *Respiratory Physiology and Neurobiology*, **161**, 182-188.
- Jones, A.M., Wilkerson, D.P., DiMenna, F.J., Fulford, J. and Poole, D.C. (2008). Muscle metabolic responses to exercise above and below the “critical power” assessed using ³¹P-MRS. *American Journal of Physiology – Regulatory, Integrative and Comparative Physiology*, **294**, R585-R593.
- Vanhatalo, A., Fulford, J., DiMenna, F. and Jones, A.M. (2010). Influence of hyperoxia on muscle metabolic responses and the power-duration relationship during severe-intensity exercise in humans: a ³¹P-MRS study. *Experimental Physiology*, **95**, 528-540.

Other conference communications

- Bailey, S.J., Wilkerson, D.P., DiMenna, F.J. and Jones, A.M. (2009). Influence of repeated sprint training on pulmonary O₂ uptake and muscle deoxygenation kinetics in humans. *BASES, Leeds*.
- Davies, R.C., Eston, R.G., Poole, D.C., Rowlands, A.V., DiMenna, F., Wilkerson, D.P., Twist, C. and Jones, A.M. (2008) Effect of eccentric exercise-induced muscle damage on the dynamics of muscle oxygenation and pulmonary oxygen uptake. *ECSS, Estorvil*.
- Jones, A.M., Wilkerson, D.P., DiMenna, F.J., Fulford, J. and Poole, D.C. (2007). Muscle metabolic responses to exercise above and below the “critical power” assessed using ³¹P-MRS. *BASES, Bath*.

Acknowledgements

The Chief

During my time at Exeter, I was often asked why I decided to come all the way to the UK to pursue my PhD. My answer was simple: “Andy Jones.” When I discovered oxygen uptake kinetics in 2004, I was eager to learn everything I could about the topic. A major part was studying the leading research in the field. Before long, I realised that the articles that were most informative all had one thing in common: One of the authors was Andrew M. Jones. That I decided to contact Professor Jones with my many questions should, therefore, come as no surprise. That he would provide immediate comprehensive answers in a courteous manner to someone he didn’t even know, however, should.

I was somewhat naïve to the PhD process when I arrived here, but it wasn’t long before I understood how critical the relationship between a student and a director of studies is. For example, I heard horror stories about poor supervision – days before e-mails were answered, appointments for meetings that had to be arranged weeks in advance – and realised that in addition to being under the tutelage of one of the top researchers in our field, I was also being supervised by a man who showed uncanny commitment to his students. Appointments for meetings? “Got a minute, Chief?” “Sure!” I trust there were many times he didn’t. And then there was the time I needed his edits of my (lengthy) *JESF* article, the deadline was upon us and he was scheduled to leave town for a conference shortly thereafter. But it was no problem because the edits were done right before leaving while lying in the magnet prior to an exhaustive exercise bout being performed for another of his students. When I became aware of how truly special The Chief’s commitment to me and all of his students was, I recognised how important it was for me to repay his efforts by showing an equal commitment to my work. Hopefully, I have met this challenge.

Team Kinetics

John F. Kennedy said, “A rising tide lifts all boats,” to describe the economy. The same can be said in the field of research and I have benefited greatly from being part of such a fine research team. My mentors Daryl Wilkerson and Mark Burnley have each provided valuable input that has aided my development. In addition, their state-of-the-art theses served as models to which I could aspire. Anni Vanhatalo was not an official member of my supervisory team, but her input was every bit as vital. Working alongside Anni has been a privilege both professionally and personally, and I will miss our lengthy chats where we discovered just how alike we really are (although Anni is much better looking and walks a lot faster). Jamie Blackwell’s important role in the lab often went unnoticed . . . at least until the inevitable problem occurred when he wasn’t around. But Jamie was far more than a lab technician as his ability to provide levity during tense moments (sometimes appreciated, sometimes not, but all looked back fondly upon now) was every bit as helpful. And then there are my fellow students: Katie Lansley went from the undergrad I called “Delta” to PhD student in the blink of an eye and Tony Chidnok came in at the end of my stay, but was very helpful during my final data collection. Oh, and Stephen Bailey . . . What can I say about The Rook? After all, I gave him that nickname when we first met because he was just a kid and, as he so astutely noted, I *was* close to his father’s age. But what I didn’t realise was the kid I was ‘showing the ropes’ was a brilliant researcher in waiting. And the wait wouldn’t be long because shortly thereafter, Rook flew from under my wing to unprecedented heights and in doing so, made me have to revise my rant about “kids nowadays.” (Now, it’s, “Other than Rook, kids nowadays . . .”) At any rate, I anticipate the day in the not-too-distant future when I’ll be sitting in a packed auditorium listening to Professor Bailey’s lecture on some groundbreaking research. But rest assured, even when that day comes, you’ll still be The Rook to me, mate!

My Family

A drawback of having parents that are older than would typically be the case when you are born is that it's inevitable that they won't be with you for much of your life. However, I was fortunate because I have had a true Mom and Dad through all of my years even though mine were gone early on. Yes, they are technically in-laws, but you wouldn't know it given the undying love and support they have shown me for 30 years. That support (both emotional and financial) has allowed me to do what I have done here and for that, I am eternally grateful.

My Angel

How did I survive here on my own for four years? Simple, I was never alone in spirit because my angel was here with me. Much like the 27 years prior, I sometimes didn't remember that was the case . . . at least until I needed help. And then, much like the past 27 years, help was always there (in this case, just an e-mail away). I have been truly blessed by all of the love and support you have given me throughout the bodybuilding years and those I have spent here at Exeter, Jeanine. I thank you from the bottom of my heart.

Other important contributors

I also owe a debt of gratitude to the administrative staff here at The University including Elaine ('Problem Solver') Davies, Alison Hume and Clare Knapman, The Man Behind the Magnet Jon Fulford, Senior Technician David Childs, computer whiz Len Maurer, supine cycle sitter and friend Harran Al-Rahamneh and, of course, all of the subjects who gave their body to science. Of particular note in the final regard are Matt Archer, Stephen Bailey, Jacob Durant, Andy Jones, Zsolt Schuller and Daryl Wilkerson.

“If at first the idea is not absurd, then there is no hope for it.”

-Albert Einstein

“It’s a rocky road, but we got there in the end.”

-Stephen Bailey

Chapter 1 Introduction

Every time American swimmer Michael Phelps exploded off the starting block at the 2008 Olympic Games in Beijing, energy was utilised by his contracting muscles. Energy is defined as the capacity of a physical system to do work and bringing home eight gold medals attests to the fact that Phelps performed a considerable amount of muscular work in the pool. However, muscular work is also done whenever we blink an eye or take a breath, so it is safe to say that energy is the essence of our very existence. The first law of thermodynamics states that energy can neither be created nor destroyed. However, it *is* possible to convert energy from one form to another and Phelps' ability to do so was, no doubt, one of the key elements responsible for his success. Humans consume chemical energy in the foodstuffs they ingest and convert this potential energy into a usable form through a series of complex enzymatic reactions. The end result is mechanical energy that manifests when contractile elements within muscle cells develop tension (contract) to facilitate movement.

Bioenergetics in the human machine

The only substrate that can supply the chemical energy required to drive contraction in mammalian skeletal muscle is adenosine triphosphate (ATP). Energy is transferred to ATP from energy-yielding reactions within the body and ATP then donates this energy to reactions that require it to perform work. There are three energetic systems that ensure ATP availability to the contractile machinery. The immediate system includes a small amount of stored ATP and another high-energy compound (phosphocreatine; PCr) that can be degraded to rapidly rebuild (phosphorylate) ATP from the by-products of ATP breakdown (adenosine diphosphate and inorganic phosphate; ADP and P_i , respectively).

The nonoxidative glycolytic system utilises carbohydrate fuels that can also be broken down quickly through a series of reactions that supply ATP in association with the net formation of lactic acid from the reduction of pyruvic acid. When glycolytic flux is slower (energy demand per unit time is less), the same series of reactions can be used with pyruvic acid oxidised and lactate equilibrium maintained. Unlike the immediate and nonoxidative glycolytic pathways, however, this form of glycolysis requires O_2 , which must be delivered from the atmosphere to mitochondria in muscle fibres where cellular oxidation takes place. Collectively, these three systems afford the capacity to satisfy a wide range of energetic requirements. The immediate and nonoxidative glycolytic systems allow for the performance of substantial amounts of work in a short period of time (high power output), but have a finite capacity because they rely on phosphorylation at the level of limited substrates and/or are associated with the accumulation of deleterious metabolic by-products. Oxidative phosphorylation has no such limitations and is, therefore, capable of satisfying metabolic demand for prolonged periods, as long as glycolytic flux rate is not excessively fast and sufficient O_2 can be delivered to and utilised by the muscle mitochondria.

O_2 delivery to and utilisation in skeletal muscle fibres

The cardiovascular and ventilatory systems are responsible for supplying O_2 to support cellular oxidation in muscle mitochondria. The convective transport of O_2 from atmosphere to muscle is a function of pulmonary ventilation, arterial oxygenation, haemoglobin concentration, cardiac output, muscle blood flow and the spatial distribution of that blood flow to active fibres. Once O_2 is delivered, its diffusion into mitochondria is determined by muscle capillarity and the O_2 gradient that exists between capillary and mitochondria. Finally, O_2 utilisation within mitochondria depends on mitochondrial

density, oxidative enzyme activity and metabolic substrate supply. Skeletal muscle O_2 uptake can, therefore, be influenced by many factors along this 'O₂ cascade' transport route.

O₂ uptake kinetics

When muscular work is abruptly increased, muscle O_2 uptake must also rise to allow oxidative phosphorylation in active muscle mitochondria to support the increased ATP demand. This increase in O_2 uptake follows an exponential response profile, which indicates the establishment of an initial error signal (difference between required amount and the amount presently consumed) and a rate of change at any response stage that is proportional to the magnitude of the ever-changing error signal at that point in time (see Figure 1.1).

An exponential profile is effective for ensuring a rapid response because it means that the highest rate of change will occur when the difference between what is required and what is available is the greatest. However, an exponential response (as opposed to a square-wave response where target demand is attained instantaneously when the change in requirement occurs) also guarantees that a shortfall will be present until the response reaches fruition. In contracting skeletal muscle, this 'O₂ deficit' is satisfied by ATP derived from non-oxidative sources. A faster oxidative response that incurs a smaller O₂ deficit is, therefore, beneficial because it reduces the need to rely on energetic alternatives that have inherent limitations. O₂ uptake kinetics is the study of the rapidity with which O₂ consumption in skeletal muscle adapts in response to a change in metabolic demand and the factor(s) along the O₂ transport/utilisation route that can potentially rate-limit this response.

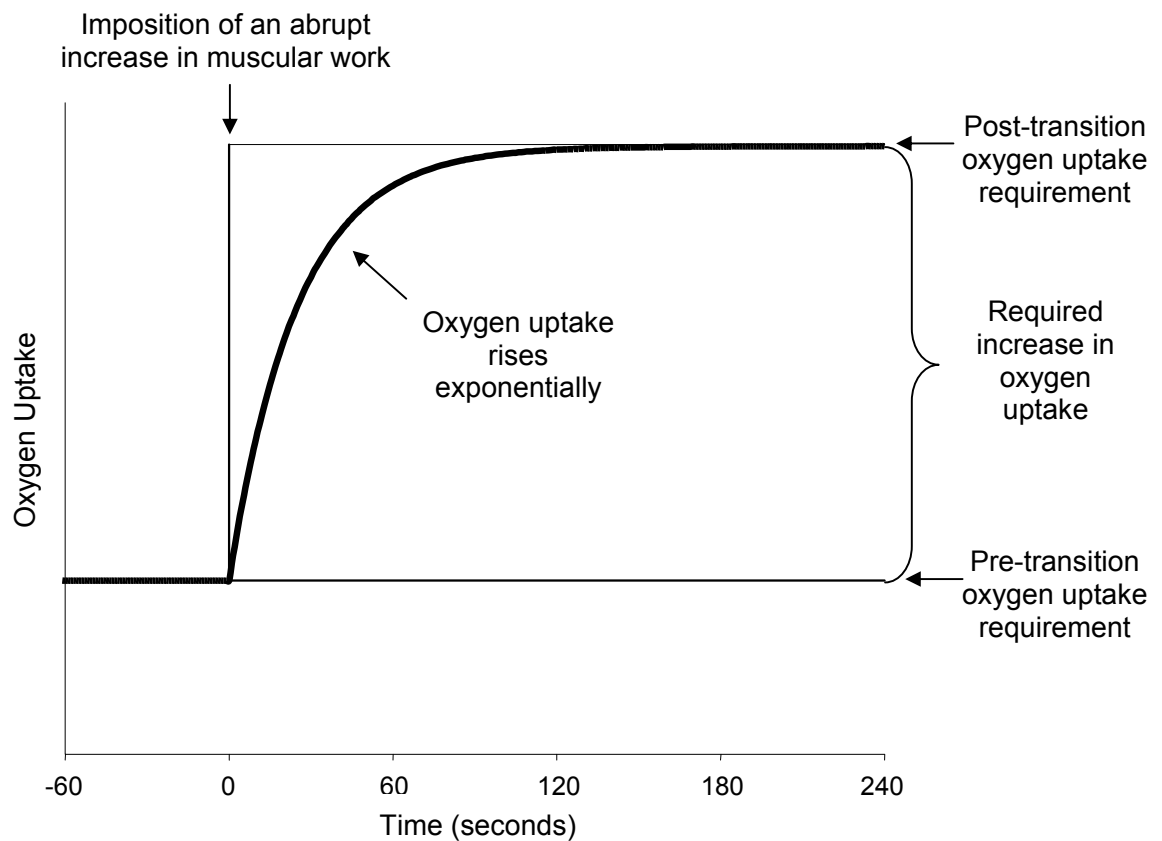

Figure 1.1: In response to a step increase in muscular work, synthesis of ATP via oxidative phosphorylation must increase to meet the newly established requirement. The associated rise in oxygen uptake follows an exponential response profile that instantaneously adjusts to the ever-changing error signal (difference between required amount and the amount presently consumed). See text for further details.

Measuring O₂ uptake

Ideally, the oxidative response in the contracting muscles of exercising humans would be assessed by the direct measurement of mitochondrial O₂ consumption. Unfortunately, technical limitations currently prevent this evaluation. Using the Fick principle, O₂ consumed across an exercising limb can be measured *in vivo* by simultaneously determining muscle blood flow in conjunction with blood O₂ content at arterial and venous sampling sites. However, while the findings from studies that have utilised this technology have been very insightful, the type of exercise that can be performed and the invasive

nature of this procedure prevent its use during 'normal' exercise conditions. Similarly, measurement of O₂ consumption in surgically isolated single muscle groups, muscles and even muscle fibres have also proved vital for furthering our understanding of the oxidative response in muscle. However, intrinsic factors critical to the process *in vivo* (e.g., muscle fibre recruitment via nervous innervation) are artificially manipulated in these preparations; therefore, some ecological validity is surely compromised. With appropriate caveats, whole body O₂ consumption measured at the mouth (i.e., pulmonary O₂ uptake; \dot{V}_{O_2}) has been shown to closely reflect the kinetics of O₂ consumption in active muscles (Barstow *et al.*, 1990; Grassi *et al.*, 1996; Krustrup *et al.*, 2009). O₂ uptake kinetics researchers typically base their findings on pulmonary \dot{V}_{O_2} measurements.

Muscle fibre-type heterogeneity

While it is common practice to refer to skeletal muscles as singular contractile entities, in reality, a muscle is made up of myriad muscle cells (fibres) with a wide range of metabolic and contractile characteristics. When a muscle is activated to contract and facilitate movement, motor units (a motoneuron and all of the fibres it innervates) are recruited based primarily upon the intensity level of the contractile activity being undertaken. Recruitment is believed to occur in a hierarchical fashion with smaller type I (slow twitch) motor units recruited first (Henneman *et al.*, 1965). At the other end of the spectrum, the largest type IIx (fast twitch) motor units discharge only when maximal or near-maximal efforts are undertaken. In addition to size, progression from one end of this recruitment hierarchy to the other also involves a shift from fibres with very high mitochondrial density and capillarity (and, therefore, considerable oxidative capacity) to those with high PCr content, a propensity for substrate-level phosphorylation and a modest ability to phosphorylate ATP by oxidative means. Not surprisingly, there is evidence to suggest that O₂ uptake kinetics

is also dramatically different in these distinct fibre types with high-order fibres responding slower and with a higher \dot{V}_{O_2} cost of tension development (Wendt and Gibbs, 1973; Crow and Kushmerick, 1982; Reggiani *et al.*, 1997). Consequently, the pulmonary \dot{V}_{O_2} signal can only be expected to reflect a ‘mean response’ of all activated fibres and this homogenisation would, presumably, span a wider range of response characteristics when large work-rate increments that necessitate activation of a fibre pool with considerable metabolic diversity are imposed.

Influence of muscle fibre recruitment on \dot{V}_{O_2} kinetics

The purpose of this thesis is to examine the influence of muscle fibre recruitment on \dot{V}_{O_2} kinetics. Specifically, subjects will perform cycle ergometer transitions from an elevated baseline work rate (‘work-to-work’ transitions) and at extremely fast and slow pedal cadences (and, therefore, muscle twitch rates) to manipulate heterogeneity within the fibre pool being recruited to perform the transition (Barstow *et al.*, 1996; Brittain *et al.*, 2001; Pringle *et al.*, 2002b; Wilkerson and Jones, 2006; Wilkerson & Jones, 2007). Interventions that have been shown to alter \dot{V}_{O_2} kinetics (cycle ergometer exercise after priming and while maintaining a supine body posture that removes the gravitational assist to muscle blood flow) will be assessed in conjunction with the aforementioned models in order to determine the fibre-type specificity of the effects that have been reported.

The following review of literature will 1) summarise the history of O_2 uptake kinetics research and the specific response characteristics that are typical under ‘normal’ exercise conditions; 2) examine the different muscle fibre types and distinctive properties that have been reported for low- and high-order fibres; 3) review O_2 uptake kinetics investigations that have employed work-to-work transitions and transitions performed at extreme pedal

cadences; and 4) examine O₂ uptake kinetics investigations that have identified the alterations caused by prior priming exercise and interventions that could potentially change certain aspects of O₂ delivery to the muscle.

Chapter 2: Review of Literature***The history of oxygen uptake kinetics****Discovery of O₂ and its role in cellular respiration*

It is difficult to pinpoint a definitive event that signalled the dawning of O₂ uptake kinetics as a field of scientific investigation. In fact, it can be argued that the birth of the discipline dates back to the very discovery of O₂ itself! In the late 1700s, Joseph Priestley and Carl Wilhelm Scheele independently discovered a gas that we now know comprises 20.93% of ambient air (Priestly, 1775; Scheele, 1912). Upon learning of their discoveries, Antoine Laurent Lavoisier named this “eminently respirable” gas oxygine and used a piece of apparatus he created to determine that the quantity in a chamber decreased when a living animal was sealed within (Lavoisier, 1789). Lavoisier’s innovative device also revealed that when O₂ was consumed by the animal, a “chalky aeroform acid” (CO₂) left the animal’s body in an approximately equal volume. This was the earliest form of indirect calorimetry, the measurement of O₂ consumption and CO₂ production to estimate body heat production and, by extension, metabolic rate. Lavoisier concluded that the rusting of metals and animal metabolism were similar processes that involved oxidation. However, before he could discover how and where oxidation took place (the prevailing belief was that it occurred in the lungs), he was tragically guillotined during the French Revolution (Sprigge, 2002).

Analysis of human gas exchange

Lavoisier’s calorimeter is an example of a spirometer (a piece of equipment that measures the volume and flow of inspired and expired air at the mouth). Specifically, it was a closed-circuit version because the animal breathed air within a sealed system. Open-circuit

spirometry involves inhalation of ambient air and is the method typically used to measure pulmonary O₂ consumption (\dot{V}_{O_2}) and CO₂ production (\dot{V}_{CO_2}) during exercise. This process involves determination of the quantity of air ventilated and the change in gas concentration that occurs when ventilated air flows through the lungs.

Soon after Lavoisier's death, English scientist Humphry Davy became the first person to use open-circuit spirometry to perform gas exchange analysis. Davy read Lavoisier's textbook (*Traité élémentaire de chimie*) and correctly concluded that biological oxidation occurred in tissues where energy was released (Sprigge, 2002). He then performed the first estimates of human O₂ consumption and CO₂ production by collecting expired air in silk bags and subsequently determining its O₂ and CO₂ content in a mercurial gasometer. By measuring and comparing the concentrations in the captured air with what was present in the air he inhaled, Davy estimated his own \dot{V}_{O_2} (484 ml·min⁻¹) and \dot{V}_{CO_2} (447 ml·min⁻¹) from a series of 20 experiments (Davy, 1800; Sprigge, 2002). Further important advances in gas exchange analysis were made in the late 1800s when German physiologists Nathan Zuntz and August Geppert constructed a device to collect and analyse expired air (Zuntz-Geppert'schen Respirationsapparat; i.e., Zuntz-Geppert respiratory apparatus) and Zuntz developed a treadmill to study respiratory activity in animals during running (Zuntz, 1897).

The Douglas bag method of gas exchange analysis

Gas exchange analysis advanced to a new level in 1911 when British scientist Claude Douglas and three colleagues from Oxford and Yale ascended Pikes Peak in Colorado to study the acute effects of altitude exposure on ventilation and respiration (Cunningham, 1964). During the expedition, Douglas used a bag collection method he developed to measure \dot{V}_{O_2} and \dot{V}_{CO_2} at rest and during muscular work. Douglas was influenced to collect

gases in this manner by childhood memories of magic lantern shows that involved storage of requisite gases (hydrogen and oxygen) in rubberized canvas bags. During his storied career, Douglas used similar bags to perform human gas exchange analysis with extraordinary speed and accuracy, thereby establishing a methodology that is practiced to this day. In fact, so powerful was his influence that this technique still bears his name (the Douglas bag method).

Douglas bag gas exchange analysis is considered the gold standard against which other methods are compared. This form of open-circuit spirometry requires the test subject to expire through a mouthpiece connected to a high-flow, low-resistance valve into a large plastic bag. After collection for specific time periods (e.g., 30 seconds), bags are sealed, mixed and subsequently emptied into a gas meter to measure total volume ventilated. A small sample from the bag is further analysed for O₂ and CO₂ concentrations, and \dot{V}_{O_2} and \dot{V}_{CO_2} are determined from these measurements.

Gas exchange analysis in the non-steady state

Douglas and partner J.S. Haldane weren't the only research team to analyse human gas exchange during the early portion of the 20th Century. In 1913, Danish physiologists August Krogh and Johannes Lindhard published a groundbreaking study detailing the changes in circulation and respiration that took place in humans during the first few minutes of work (Krogh and Lindhard, 1913). Unlike prior researchers dating all the way back to Lavoisier, these were the first to characterise \dot{V}_{O_2} in the non-steady state (i.e., the transition phase before a match between oxidative energy provision and energetic demand is achieved). Krogh and Lindhard measured gas exchange during rest-to-exercise transitions on a cycle ergometer and discovered that the increase in \dot{V}_{O_2} upon initiation of

work was rapid but, importantly, not instantaneous. They also identified a latent period of “a couple seconds” prior to the response that they attributed to rapid chronotropic adaptation with inadequate venous supply (and, therefore, diminished systolic output), and suggested that for at least the first 6-10 seconds, the increase in O₂ consumption by active tissue would be accompanied by a “nearly proportional” increase in circulation (i.e., tissue O₂ consumption would increase, but the O₂ tension of venous blood returning to the lungs would remain constant). Finally, they attributed the “considerable increase in O₂ absorption” that followed to an additional (although smaller) increase in circulation, but suggested greater complexity by recognising that O₂ extraction would also be increasing during this stage.

Bag collection of expired gases provides a viable way to determine \dot{V}_{O_2} and \dot{V}_{CO_2} during steady state conditions where values remain relatively constant for extended periods and even during shorter measurement intervals, but not with the temporal resolution necessary to precisely characterise a rapidly changing response. For example, while Krogh and Lindhard correctly determined that \dot{V}_{O_2} does not immediately reach the requisite value when muscular work is initiated, the response characterisation they provided was understandably vague (Krogh and Lindhard, 1913). Their initial measurement consisted of air collected over the first ~12 seconds of work and two more collections were made during the first minute. In conjunction with \dot{V}_{O_2} estimates they obtained in prior investigations where subjects performed single expiratory efforts of different durations to residual volume both before and after the initiation of work (to provide data that would presumably represent what occurred during the first few seconds of the response), these data allowed for the general response description they provide.

The third decade of the 20th Century saw the next important advance in our understanding of the oxidative response following the onset of exercise. After being awarded the Nobel Prize for his work on contracting skeletal muscle and associated heat production in 1922, A.V. Hill and colleagues set forth to link observations they made on frog muscle isolated *in vitro* with physiology that took place in exercising man (Hill *et al.*, 1924). To do so, they used a portable Douglas bag gas collection system to measure \dot{V}_{O_2} and \dot{V}_{CO_2} as subjects walked and ran on an open-air track. Importantly, this system also included a series of taps that provided the ability to instantaneously switch between multiple collection bags. These were used during the transitions to and from exercise to obtain a rapid succession of samples, thereby providing data with greater temporal resolution during transient response phases. The main purpose of this research was to determine how the O₂ that was consumed during exercise compared to the amount that was actually required.

Hill and Lupton believed that the anaerobic energy production that satisfied the O₂ deficit at exercise onset was directly responsible for the increased O₂ that was consumed once exercise was ceased. Their estimates of the O₂ cost of running were, therefore, determined by adding the measured consumption during a bout to the amount consumed above resting level afterwards. We now know that these estimates were incorrect because post-exercise O₂ consumption is more complex than this 'O₂-debt' theory would imply (Gaesser and Brooks, 1984). Nevertheless, Hill and Lupton correctly determined that despite the initial response lag, subjects eventually (i.e., after "2 or 3 minutes") achieved an O₂ consumption that was equal to the requirement (i.e., steady state \dot{V}_{O_2}) at lower running speeds, but that fell short of the requirement and was unable to be exceeded (i.e., $\dot{V}_{O_{2max}}$) at the highest speeds. They also published diagrams of their results that revealed an oxidative response profile characterised by a decreasing rate of change as progression to the eventual plateau

took place (e.g., see Hill and Lupton, 1924; p. 167). However, these researchers were only concerned with analysing the post-exercise response and made no attempt to mathematically characterise the exponential rise they discovered at exercise onset. Surprisingly, almost 30 years would pass before others did!

The dynamic $\dot{V}O_2$ response to exercise*Implications for metabolic control*

In 1951, F.M. Henry suggested that during muscular work supported by sufficient O_2 delivery, O_2 intake is determined by the availability of oxidizable metabolic substrate (e.g., Krebs cycle intermediates) and proposed a model by which the rate of accumulation of this provision would increase in an exponential manner during the transition to constant-load work (Henry, 1951). By extension, Henry hypothesised that oxygen consumption during a transition could be calculated as:

$$Y(t) = a_o(1 - e^{-kt})$$

where $Y(t)$ is oxygen consumption at time t , a_o is the steady state rate of oxygen consumption (the response amplitude once equilibrium is achieved between the accumulation and oxidation of the controlling substrate) and k is a velocity constant that would be entirely independent of (i.e., mathematically uncorrelated with) both a_o and the work rate that elicited the response. With this system of feedback control, a_o would increase linearly with work rate, at least up to the point where systemic limitations prevented a further rise. Henry tested his hypothesis by measuring O_2 uptake with subjects cycling at a variety of workloads and observed response curves that were satisfactorily described by the exponential model he proposed. However, it is important to note that subjects exercised at relatively light workloads that would have utilised only a small fraction of their metabolic reserve in this study.

The system proposed by Henry (1951) would be characterised by predictable oxidative response behaviour (an unchanged velocity constant and an O_2 cost that increased linearly

as a function of work rate) throughout its range of capacity. This would indicate linear first-order system control. However, in 1956, Henry and research partner J.C. DeMoor published findings that challenged this notion (Henry and DeMoor, 1956). Specifically, they demonstrated that the time to reach a steady state in O_2 consumption increased with increasing work rates when subjects performed exercise of graded intensity. Henry and DeMoor, therefore, suggested that an equation with two exponential components was necessary to describe the rise of O_2 uptake during exercise.

Breath-by-breath gas exchange measurement technology

During the sixties, technological advancements dramatically changed open-circuit spirometry as computers and fast-responding O_2 and CO_2 analysers were developed. This form of gas exchange analysis involves the measurement of flow volume at a mouthpiece through which inhalation and exhalation take place. Expired air is sampled for gas concentrations via an attached gas line and instantaneous calculations of O_2 uptake and CO_2 production are provided in an on-line manner. This new technology allowed for the measurement of pulmonary gas exchange on a breath-by-breath basis and when data collected by these systems were averaged over specific time periods, the $\dot{V}O_2$ and $\dot{V}CO_2$ estimates were similar to those indicated by Douglas bag collection. This confirmed the accuracy of the new technology and validated its use to precisely characterise the time course of the pulmonary oxidative response to exercise.

Linear first-order oxidative control

Despite the enhanced temporal resolution offered by rapidly responding breath-by-breath gas analysis systems, definitive findings regarding the presence of linear first-order oxidative control were still lacking in the late sixties. For example, in 1967, Karlman

Wasserman and colleagues had subjects perform constant-load cycle exercise at three different intensities determined relative to their individual capacity (Wasserman *et al.*, 1967). Specifically, they used an incremental cycling test to exhaustion with four-minute stages to identify the point at which the gas exchange ratio increased abruptly for each subject and subsequently had them perform a work rate just below this “anaerobic threshold.” They defined this as “moderate exercise.” Wasserman *et al.* (1967) also had subjects perform “heavy” and “very heavy” work intensities (700 and 1500 ml·min⁻¹ of O₂ consumption above the moderate work rate, respectively) and found that achievement of a “true steady state” was delayed (not reached in less than 10 minutes compared to within four minutes during moderate exercise) or even unattainable during the more challenging bouts. Conversely, Di Prampero *et al.* (1970) observed invariant O₂ uptake kinetics (a half-time to $\dot{V}O_2$ steady state of ~27-30 s) that was adequately described by a single exponential function for all metabolic transitions from rest to a variety of arbitrarily determined work levels during both stepping and cycle exercise. Interestingly, these researchers also found that transitions from mild to heavier exercise were characterised by faster response kinetics (a $\dot{V}O_2$ half-time of 17 s) and suggested that the influence of the utilisation of body O₂ stores that would normally dissociate pulmonary from muscle O₂ consumption during full transitions was absent during transitions initiated from an elevated baseline work rate.

Oxidative system nonlinearity: the $\dot{V}O_2$ slow component

In 1972, Wasserman and Brian J. Whipp published research that proved beyond a doubt that oxidative energy transfer demonstrates nonlinear behaviour (Whipp and Wasserman, 1972). Breath-by-breath $\dot{V}O_2$ measurements collected as subjects cycled at six different constant work rates revealed that a steady state rate of O₂ consumption was, in fact, progressively delayed (or even not yet attained by exercise cessation at minute six) at

higher work rates and, indeed, so pronounced was this slowing that the hypothesis forwarded by Henry some 15 years prior was confirmed: The response at higher work rates appeared to comprise two exponential components with the second describing all changes occurring after approximately three minutes of the initial response. Accordingly, Whipp and Wasserman (1972) suggested measurement of the $\dot{V}O_2$ increase post-minute-three (e.g., $\Delta\dot{V}O_{2(6-3)}$ for six-minute exercise bouts) as a useful index to quantify this additional response phase and also cited its late emergence to explain why prior investigators (e.g., Margaria *et al.*, 1965; Di Prampero *et al.*, 1970) found an invariant $\dot{V}O_2$ time course that conformed to a single exponential throughout a wide range of work intensities. In these studies, Whipp and Wasserman (1972) concluded that exercise bouts were not continued long enough for this additional ' $\dot{V}O_2$ slow component' to be discerned.

The three-phase $\dot{V}O_2$ response at exercise onset

As a more thorough understanding of the oxidative response to exercise evolved during the sixties and seventies, it is interesting to note that the pre-response latent period that was originally reported (Krogh and Lindhard, 1913) was not accounted for in typical characterisations. In fact, Henry's initial model (Henry, 1951) and subsequent ones (e.g., Margaria *et al.*, 1965; Whipp, 1971) all suggested an exponential process that began immediately when work rate was increased. This is counterintuitive because even if an exponential oxidative response is initiated simultaneously with workload application at the precise site of cellular oxidation, this response would not be reflected in altered pulmonary gas tensions until the spatial divide between muscle and lung had been crossed. A research team headed by Whipp and Wasserman addressed this contradiction in 1982 by undertaking a rigorous analysis of pulmonary gas exchange response kinetics during transitions to moderate-intensity cycle exercise (Whipp *et al.*, 1982). These researchers

theorised that studies that employed Douglas bag measurements typically used collection periods that were too long to reveal a delay phase and further suggested that sufficient sensitivity was also lacking from breath-by-breath analyses due to the large interbreath fluctuations that are present in the pulmonary signal. Whipp *et al.* (1982) solved these problems by measuring pulmonary gas exchange during repeat performance of the same transition (cycle exercise at a work rate below the subject's anaerobic threshold) and linearly interpolating the breath-by-breath data they acquired so that second-by-second values from like transitions could be time aligned and ensemble averaged. Used previously (Linnarsson, 1974), this methodology served to enhance signal-to-noise ratio.

Whipp *et al.* (1982) revolutionised the study of the $\dot{V}O_2$ response to exercise on two fronts. Importantly, the repeat-trial protocol they used became the standard procedure for all state-of-the-art $\dot{V}O_2$ kinetics investigations from that point forward. Furthermore, they identified an initial response phase (termed "phase I") that preceded the $\dot{V}O_2$ rise (phase II) and steady state (phase III), and showed that it is essential to account for this component when using pulmonary measurements to determine the exponential process that presumably reflects the muscle $\dot{V}O_2$ response.

The cardiodynamic phase

Phase I consists of a muscle-to-lung transit delay (the time that elapses before measurements across the lung accurately reflect tissue gas exchange at the sites of oxidation) and the use of body gas stores that allow a cellular O_2 uptake increase to be satisfied without alteration of mixed venous O_2 tension. Therefore, characterising the muscle oxidative response by fitting pulmonary $\dot{V}O_2$ data with an exponential constrained to commence simultaneously with work rate (i.e., one that conforms to a model with no time

delay; e.g., the function proposed by Henry in 1951) will result in a distorted fit (Whipp *et al.*, 1982). Additionally, a rapid increase in pulmonary perfusion exerts an influence on pulmonary gas exchange (as indicated by the Fick Equation: pulmonary $\dot{V}O_2$ = pulmonary blood flow x arterio-venous O_2 difference) during this phase. The resulting increase in pulmonary $\dot{V}O_2$ does not represent O_2 uptake by the tissues and can also serve to obscure the pure time delay that would be apparent if this ‘cardiodynamic’ effect were not present. The end result is $\dot{V}O_2$ values throughout phase I that will distort a best-fit curve even if a more appropriate exponential model with time delay is employed (Whipp and Rossiter, 2005). Consequently, it was determined that the best fit for phase II was achieved when an exponential function constrained to start at the “inflection point” (i.e., the point of transition from phase I to phase II as determined by visual inspection; on average, 19 seconds after exercise onset) was used (Whipp *et al.*, 1982).

The $\dot{V}O_2$ slow component and critical power

Once it was confirmed that attainment of a steady state $\dot{V}O_2$ was delayed for work intensities above the anaerobic threshold, the ‘slow component’ responsible for this departure from system linearity was studied extensively. In 1988, an important investigation greatly improved our understanding of both the possible mechanistic bases of the slow component and also how it affected exercise tolerance. David Poole and associates studied high-intensity cycle exercise both at and slightly above the power output defined by the asymptote of the power/time-to-fatigue hyperbola and found that this demarcation point (i.e., the point typically termed the ‘critical power’ or CP; e.g., see Monod and Scherrer, 1965; Moritani *et al.*, 1981) also separates intensity regions characterised by markedly different $\dot{V}O_2$ responses (Poole *et al.*, 1988). These researchers found that constant-load cycle exercise at CP could be maintained for 24 minutes (the requisite duration as per

methodological design) by all subjects, whereas cycling at a power output five percent above it (15 W, on average) could only be maintained for ~18 minutes. Additionally, a steady state $\dot{V}O_2$ was delayed, but attainable (i.e., reached within 12-20 minutes) when cycling at CP; however, above it, $\dot{V}O_2$ continued to rise until attaining a value at exhaustion that was not different from the $\dot{V}O_{2max}$ indicated by an incremental ramp test. The authors concluded that exercise characterised by the presence of a $\dot{V}O_2$ slow component (i.e., above the anaerobic threshold) encompasses two distinctly different intensity domains – one where $\dot{V}O_2$ attains a delayed steady state below $\dot{V}O_{2max}$ and one comprised of a range of different intensity/time-to-exhaustion combinations where, in each case, $\dot{V}O_2$ does not stabilise, but reaches its maximum value at exhaustion. Interestingly, blood lactate responded in a similar manner and a very strong correlation between these two variables was observed.

$\dot{V}O_2$ as a proxy for muscle O_2 uptake

Collectively, demonstration of the three-phase pulmonary $\dot{V}O_2$ response to moderate exercise (Whipp *et al.*, 1982) and the additional $\dot{V}O_2$ slow component at higher work rates (Whipp and Wasserman, 1972; Poole *et al.*, 1988) provided an elegant explanation of how pulmonary $\dot{V}O_2$ adapts to an abrupt increase in muscular work. However, before mechanistic inferences with respect to gas exchange at the actual sites of biological oxidation (active muscle mitochondria) could be drawn, the degree to which pulmonary $\dot{V}O_2$ reflects muscle $\dot{V}O_2$ had to be determined. In a study published in conjunction with Whipp and Norman Lamarra in 1990, Thomas J. Barstow modelled venous circulation to assess how changes in vascular volume between muscle and lung, and different circulatory rates, affected the association between muscle and pulmonary $\dot{V}O_2$ (Barstow *et al.*, 1990). These computer-simulated representations revealed that while phase I pulmonary dynamics can be

altered by these changes, phase II measurements are not appreciably distorted. This provided theoretical justification for the use of the phase II portion of the pulmonary $\dot{V}O_2$ response to estimate the time course of O_2 uptake in active muscle mitochondria.

A number of subsequent investigations provided empirical confirmation of Barstow's model. In 1996, Grassi *et al.* used constant-infusion thermodilution to measure leg blood flow in conjunction with arterial and venous blood sampling to determine the difference in O_2 content across the leg (Grassi *et al.*, 1996). Taken during exercise bouts of moderate intensity, these measurements allowed leg O_2 uptake to be determined via the Fick Principle and when estimates of the time constant describing the exponential rise in leg $\dot{V}O_2$ were compared with that for the phase II pulmonary $\dot{V}O_2$ response, no significant difference was found. These findings were confirmed in subsequent studies when it was shown that phase II pulmonary $\dot{V}O_2$ measurement also closely reflects the kinetics of muscle O_2 uptake during high-intensity exercise (Bangsbo *et al.*, 2000; Krstrup *et al.*, 2009). Furthermore, a harmonious relationship between O_2 uptake at the muscle and lung had already been shown during the slow phase of the pulmonary $\dot{V}O_2$ response. Using the same technology that Grassi utilised five years later, Poole *et al.* (1991) showed that the vast majority (~85%) of the increase in pulmonary $\dot{V}O_2$ occurring post-minute-three during high-intensity exercise resulted from a similar increase in O_2 uptake by the exercising limb. In addition to justifying pulmonary $\dot{V}O_2$ as an accurate indicator of active muscle oxidation during exercise, this finding also provided valuable insight into mechanisms that could be responsible for at least the predominant portion of this phase of the response because it ruled out factors that were not intrinsic to the exercising musculature (e.g., the $\dot{V}O_2$ cost of ventilatory, cardiac and accessory muscle work, increased body temperature and circulating metabolites).

O₂ uptake kinetics: a coming of age

If Lavoisier's work some 200 years prior constituted the birth of O₂ uptake kinetics as a field of scientific investigation, Whipp and Wasserman's landmark studies and the contributions from research teams involving Barstow, Poole, Grassi and Bangsbo paved the way for its maturation. Breath-by-breath gas exchange analysis systems became readily available in the nineties and it was universally accepted that with appropriate caveats, breath-by-breath pulmonary $\dot{V}O_2$ measurements provided a non-invasive way to closely estimate muscle $\dot{V}O_2$ in both phase II and the slow phase of the response. A marked increase in related research followed, a textbook devoted exclusively to $\dot{V}O_2$ kinetics was written and a discipline steeped in tradition saw the next generation of scientists carry the investigative torch to new heights.

Characterising the $\dot{V}O_2$ response at exercise onset*Accounting for phase I*

Whipp *et al.* (1982) showed that the phase II $\dot{V}O_2$ response is best fit by a single exponential constrained to start at the inflection point that denotes the end of the masking influence of the initial rush of cardiac output through the lung. Unfortunately, this delineation point is not always easy to recognise due to inherent ‘noise’ within the pulmonary $\dot{V}O_2$ signal. Consequently, $\dot{V}O_2$ kinetics researchers have typically employed other methods to ensure that phase I data are not included in the phase II fit. Some groups have chosen to assign a separate exponential term to describe this portion of the response while others attempt to eliminate it from consideration by omitting data collected from exercise onset to a specific time point determined *a priori* (Whipp and Rossiter, 2005). As the state of the art has evolved, the latter method has been used more frequently, with the first 20 seconds typically specified as the timeframe of choice. Justification for this approach includes:

- lack of experimental evidence or physiologic rationale to suggest that the phase I response should be exponential in nature;
- realisation that including more parameters in a model should be avoided if possible because doing so decreases the degrees of freedom, thereby lowering the confidence in the more important parameter estimates describing the fit (Whipp and Rossiter, 2005);
- demonstration that, on average, the ‘smooth’ exponential response (i.e., the post-inflection point profile) begins ~19 s after exercise onset (Whipp *et al.*, 1982);
- demonstration that the mean transit time from muscle capillary to lung is ~17 s just before exercise and ~10-12 s after 10 s of exercise (Krustrup *et al.*, 2009) with muscle $\dot{V}O_2$ increasing after no delay (Grassi *et al.*, 2002; Kindig *et al.*, 2003).

It is important to realise that choosing to eliminate the first 20 seconds before fitting phase II is not a concession that deoxygenated blood from exercising muscle must arrive at the lung exactly 21 seconds after exercise onset. Blood with gas tensions that have been altered by exercise might very well arrive sooner; however, this alteration will likely be obscured by the cardiodynamic effect and inclusion of this misrepresentative data will result in a distorted phase II fit (Whipp *et al.*, 1982; Whipp and Rossiter, 2005). Conversely, if some phase II data is unconcealed prior to 20 s of exercise, omitting this from consideration will not confound parameter estimation because enough representative data will still be available to ‘find’ the exponential response. It is, therefore, favourable to err on the side of caution and risk elimination of some valid data points to ensure that no cardiodynamic distortion of phase II occurs. However, it is also important to recognise that when conditions are present that result in a sluggish cardiovascular response to exercise, a prolongation of phase I (e.g., for a time period that is greater than 20 seconds) might be present (Poole *et al.*, 2005). This means that in these circumstances, simply eliminating the first 20 seconds of data would not suffice and a precise determination of phase I length (e.g., identification of the inflection point; see above) would be required.

Characterising phase II

Phase II pulmonary $\dot{V}O_2$ kinetics provides a close approximation of muscle $\dot{V}O_2$ kinetics following exercise onset (Barstow *et al.*, 1996; Bangsbo *et al.*, 2000; Krstrup *et al.*, 2009). Therefore, accurate description of the exponential response profile that characterises this phase forms the basis of $\dot{V}O_2$ kinetics analysis. The phase II $\dot{V}O_2$ response is typically fit using a nonlinear least-square algorithm, as described by the following equation:

$$\dot{V}O_2(t) = \dot{V}O_{2 \text{ baseline}} + A(1 - e^{-(t-TD)/\tau})$$

where $\dot{V}O_2(t)$ represents the absolute $\dot{V}O_2$ at a given time t ; $\dot{V}O_{2\text{baseline}}$ represents the mean $\dot{V}O_2$ in the baseline period and A , TD , and τ represent the response amplitude, time delay and time constant, respectively. The amplitude term represents the asymptotic value to which the exponential projects; therefore, the sum of this term and the mean $\dot{V}O_2$ in the baseline period is equivalent to the absolute $\dot{V}O_2$ required at steady state. (Note: This only applies to moderate-intensity exercise because at higher intensities, the $\dot{V}O_2$ slow component confounds this interpretation). Similarly, the time delay designates the point at which the exponential begins (i.e., pulmonary $\dot{V}O_2$ rises due to the return of blood with altered gas tensions to the lung) and the time constant describes the rate at which it progresses. Specifically, τ is equivalent to the reciprocal of the rate constant and, therefore, represents the time taken to achieve 63% of the asymptotic value. In addition, for inter-subject comparisons or assessment of transitions of different magnitude within the same subject, the functional ‘gain’ (G) of the response is often determined by normalising the amplitude term to the increment in work rate (i.e., $\Delta\dot{V}O_2/\Delta\text{work rate}$, which is the inverse of the equation typically used to determine the percentage of energy turnover that appears as external work; i.e., contractile efficiency).

Characterising the $\dot{V}O_2$ slow component

Whipp and Wasserman showed that the time to achieve a steady state $\dot{V}O_2$ increases greatly with increasing work rates above what they termed the anaerobic threshold due to what has come to be known as the $\dot{V}O_2$ slow component and suggested that the change in $\dot{V}O_2$ after minute three ($\Delta\dot{V}O_{2(6-3)}$) provides a useful index for quantifying this additional oxidative cost of high-intensity exercise (Whipp and Wasserman, 1972). Subsequent studies revealed that the slow component typically emerges sooner (e.g., after ~90-120 seconds), especially at higher work rates, so $\Delta\dot{V}O_{2(6-2)}$ became the preferred method (Jones and Poole,

2005). However, this index was still only capable of providing a gross estimate of the slow component and, therefore, a more precise quantification method was required. Although there is still limited understanding of the aetiology of this phenomenon, it is apparent that it is superimposed on the primary response. Consequently, fitting the entire $\dot{V}O_2$ response to exercise that elicits a slow component with the single exponential model outlined previously will result in a poor fit (i.e., residuals that are biased to accommodate distortion of the primary exponential curve; e.g., see Figure 2.1).

Initially, it was assumed that the primary and slow components represented separate processes that emerged in concert (Linnarsson, 1974; Barstow and Mole, 1987; Casaburi *et al.*, 1989), but in 1991, findings from two research groups suggested that the slow component emerges some time after exercise onset (Paterson and Whipp, 1991; Barstow and Mole, 1991). Consequently, the $\dot{V}O_2$ response profile to exercise eliciting a slow component requires a fitting model that allows for a delayed-onset term. However, each group used a different method to describe this term. Paterson and Whipp (1991) extrapolated the monoexponential phase of the $\dot{V}O_2$ response to end exercise and calculated the slow component as the difference between actual and modelled $\dot{V}O_2$ values at this time point whereas Barstow and Mole (1991) used a double exponential equation that contained a slow component term of its own:

$$\dot{V}O_2(t) = A_1(1 - e^{-(t-TD_1)/\tau_1}) + A_2(1 - e^{-(t-TD_2)/\tau_2})$$

Finally, it has been suggested that the slow component might be better described by a linear fit, particularly when a biexponential model reveals a slow component τ well in excess of the duration of data collection (Linnarsson, 1974; Engelen *et al.*, 1996). Consequent to this

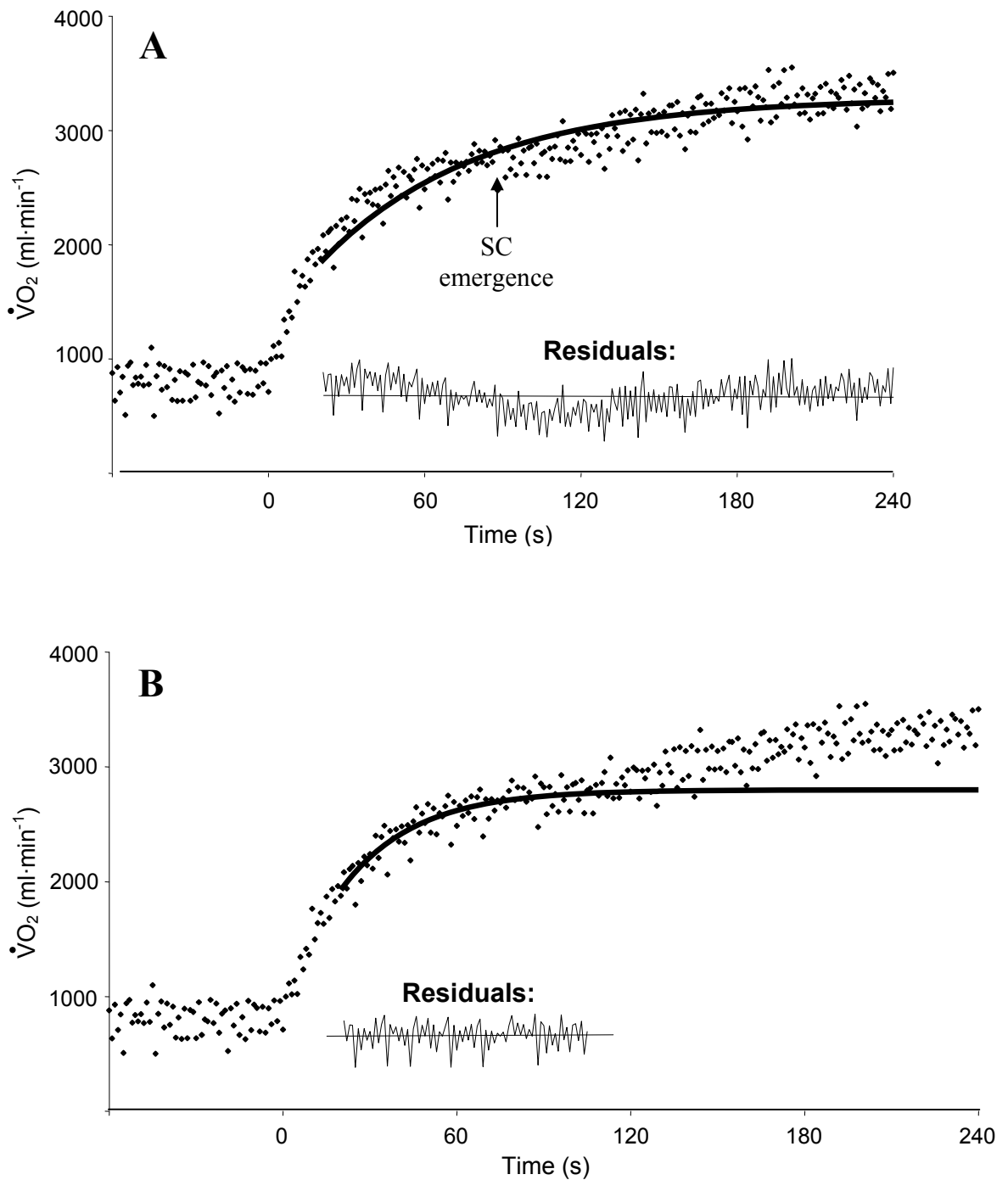

Figure 2.1: Panel A illustrates a monoexponential fit to $\dot{V}O_2$ data that includes a slow component superimposed on the primary exponential response. To accommodate the progressive increase of $\dot{V}O_2$ as exercise proceeds, the fit is biased (see plot of residuals), the τ defining the exponential is excessively long (60 s) and the TD is negative (-13 s). However, if the fit is constrained to the point where the slow component begins to emerge (see Panel B), unbiased residuals throughout the phase II region indicate that a true representation of the phase II time course has been revealed ($\tau = 25$ s).

uncertainty, a consensus opinion of the preferred method was and is still lacking, and different methods are employed by the groups currently doing research in the field.

The lactate/gas exchange threshold

Whipp and Wasserman's seminal work implicated the 'anaerobic threshold' as the metabolic rate above which a $\dot{V}O_2$ slow component changed the predictable nature of the $\dot{V}O_2$ response (Whipp and Wasserman, 1972). In the ensuing years, there has been considerable ambiguity regarding the precise definition of this important delineation point. This is, perhaps, not surprising given the fact that anaerobic metabolism supplements aerobic energy transfer throughout the entire range of metabolic capacity such that there is, in fact, no threshold to definitively signal its onset. However, Whipp and Wasserman's anaerobic threshold does correspond with the metabolic rate above which blood lactate concentration begins to rise above baseline levels. Consequently, 'lactate threshold' is an appropriate term that specifically identifies this point (Connett *et al.*, 1990). This threshold also demarcates the beginning of an intensity range where bicarbonate buffering obligates the generation of non-metabolic CO_2 . This affects both pulmonary gas exchange and ventilation and, therefore, the lactate threshold can be conveniently identified non-invasively by determining the gas exchange threshold (GET) from pulmonary $\dot{V}O_2$ and $\dot{V}CO_2$ measurements during incremental exercise (Beaver *et al.*, 1986). Specific criteria used to identify this breakpoint include:

- the first disproportionate increase in $\dot{V}CO_2$ from visual inspection of individual plots of $\dot{V}CO_2$ v. $\dot{V}O_2$;
- an increase in $\dot{V}_E/\dot{V}O_2$ with no increase in $\dot{V}_E/\dot{V}CO_2$;
- an increase in end-tidal O_2 tension with no fall in end-tidal CO_2 tension.

Exercise intensity domains

Discovery of intensity-specific differences in the metabolic and gas exchange responses to constant-load exercise meant that the customary practice of assigning work rates as a percentage of $\dot{V}O_{2\max}$ was unacceptable for normalising intensities between subjects or under different conditions within the same subject. Instead, work rates had to be specified relative to definitive intensity domains. Unfortunately, the traditional exercise physiology community has been slow to grasp this notion (DiMenna and Jones, 2009) and even pre-eminent $\dot{V}O_2$ kinetics researchers have yet to reach common consensus on a universal categorisation system (Jones and Poole, 2005; Whipp and Rossiter, 2005). In the past, one of two schemata illustrated in Figure 2.2 (designated arbitrarily here as A and B) has been

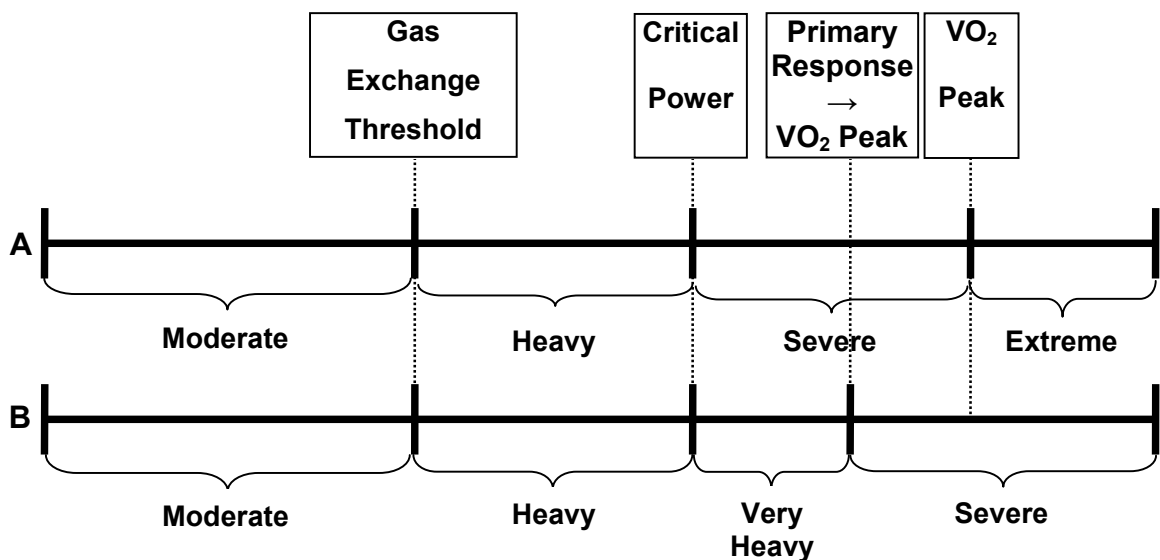

Figure 2.2: Two schemata typically used to quantify exercise intensity relative to metabolic capacity. Note: The key difference between Schemata A and B is that within the latter, the point at which the primary response to the work rate results in the attainment of $\dot{V}O_{2\text{peak}}$ defines a domain boundary (very heavy/severe), whereas within the former, a distinction is made for work rates that cannot be sustained long enough for $\dot{V}O_{2\text{peak}}$ to be achieved (extreme). See text for further details.

used by the various groups; schema A is used throughout this thesis. However, despite this disparity, there is commonality regarding how intensities are specified in all credible $\dot{V}O_2$ kinetics research. A ramp incremental exercise test to exhaustion is administered prior to constant-load testing and the work rate associated with the gas exchange threshold and the peak attainable work rate are noted. Exercise intensity is then stated as a percentage of either the gas exchange threshold (e.g., 80% GET) for moderate exercise or delta (Δ ; the difference between the gas exchange threshold and peak $\dot{V}O_2$) for exercise that is heavy or severe.

For healthy young adults exercising within the moderate-intensity domain, a steady state $\dot{V}O_2$ is usually reached within 2-3 minutes (Whipp and Wasserman, 1972; Whipp and Mahler, 1980) and blood lactate concentration is not elevated above baseline once $\dot{V}O_2$ achieves this plateau. The $\dot{V}O_2$ cost of moderate-intensity cycle ergometry is typically 9-11 ml·min⁻¹·W. During heavy exercise, the oxidative cost is greater and attainment of a steady state $\dot{V}O_2$ is delayed due to the presence of the $\dot{V}O_2$ slow component (Whipp and Wasserman, 1972; Linnarsson, 1974; Whipp and Mahler, 1980; Roston *et al.*, 1987; Barstow and Mole, 1991; Paterson and Whipp, 1991). Blood lactate concentration increases above baseline during heavy exercise; however, it does eventually reach equilibrium (i.e., appearance matched by removal), albeit at an elevated level. In fact, the maximal intensity at which blood lactate concentration equilibrium is still possible (i.e., the ‘maximal lactate steady state’) is roughly equivalent to the intensity level that defines the upper boundary of this domain (i.e., the critical power) (Smith and Jones, 2001; Pringle and Jones, 2002). Conversely, severe exercise can only be maintained for a finite duration and attainment of $\dot{V}O_{2max}$, as opposed to a submaximal $\dot{V}O_2$ steady state, is inevitable (Poole *et al.*, 1988). Exercise within this domain will also be characterised by the presence of a $\dot{V}O_2$

slow component, at least in cases where exercise can be continued long enough to allow it to be manifest. However, in this case, the slow component will cause $\dot{V}O_2$ to rise inexorably until $\dot{V}O_{2max}$ is reached. Generally speaking, CP occurs at $\sim 50\% \Delta$ (Poole *et al.*, 1988; Pringle and Jones, 2002), so if the intention is to investigate exercise within the severe domain, intensities of 60-80% Δ are typically studied. Finally, during extreme exercise, the ability to sustain exercise is so limited that there is insufficient time for $\dot{V}O_{2max}$ to be attained (Hill *et al.*, 2002) and there is also no $\dot{V}O_2$ slow component that can be discerned.

Oxidative control system analysis

Boltzmann's principle of superposition

A first order system is one whose input-output relationship can be adequately described by equations whose operators are a series of linear differential equations (Rossiter *et al.*, 2005). First-order linearity with respect to oxidative control would, therefore, mandate:

- on-off response symmetry to repeating functions;
- a system τ , TD and G that are independent of the baseline work rate from which the response is elicited;
- a system τ , TD and G that are independent of the amplitude and frequency of the forcing function that elicits the response.

Boltzmann's principle of superposition forms the basis for defining linearity (Fujihara *et al.*, 1973b). This principle states that the response of a linear system to two separate inputs is additive (i.e., the sum of the responses elicited by each input if the other were not present). Input-output analysis provides a model that has been used to test cardiorespiratory response linearity in order to speculate upon the potential mechanism(s) of control. For example, in 1973, Fujihara *et al.* found that in the majority of cases, Boltzmann's law of superposition could be applied to work load/ventilation and work load/HR relationships when impulse (large, short and small), step (large and small) and ramp (large and small) loads forced oxidative function during cycle ergometer exercise (Fujihara *et al.*, 1973a). Consequently, they were able to develop transfer functions that implicated feedback from spatially-distanced (in relation to the actual sites of cellular oxidation) chemoreceptors to explain the delayed ventilatory drive compared to a virtually immediate HR acceleration likely arising from intramuscular signalling or cortical irradiation (Fujihara *et al.*, 1973a). However, a definitive identification of the transfer

function that controls muscle O₂ consumption was and is still lacking (Rossiter *et al.*, 2005).

Work-to-work exercise transitions – early findings

When Whipp *et al.* (1982) elucidated the non-steady state \dot{V}_{O_2} response, they assessed cycle transitions initiated from either rest or unloaded (0 W) cycling and found that varying the baseline in this manner affected the abruptness and magnitude of phase I, but not its duration or the subsequent phase II τ . This confirmed that either strategy provided a suitable model for determining the phase II exponential oxidative time course. However, most subsequent studies have used the latter approach because the \dot{V}_{O_2} cost of moving the legs against no load at the employed pedal cadence (e.g., $\sim 250 \text{ ml}\cdot\text{min}^{-1}$ at $50\text{-}70 \text{ rev}\cdot\text{min}^{-1}$ and up to $\sim 1000 \text{ ml}\cdot\text{min}^{-1}$ at extremely fast cadences) can be accounted for. This allows for accurate determination of the phase II G, which should not include this additional energetic expense. It has also become common practice to apply a 20-W load during this ‘unloaded’ baseline cycling period because it is generally believed that ergometer linearity can not be easily validated for lesser values.

While full transitions from rest or ‘unloaded’ cycling are typically examined in \dot{V}_{O_2} kinetics investigations, partial transitions from an elevated baseline (i.e., work-to-work transitions) have also been studied and notable differences have been observed. As previously mentioned, Di Prampero *et al.* (1970) assessed work-to-work transitions during both stepping and cycling, and reported a faster \dot{V}_{O_2} half-time compared to the full control transition. Two years later, Davies *et al.* (1972) reported similar findings; specifically, an invariant \dot{V}_{O_2} half-time of $\sim 30 \text{ s}$ for rest-to-light and rest-to-heavy treadmill exercise transitions that was reduced to 17 s for the light-to-heavy adaptation. Conversely, Casaburi

et al. (1977) used breath-by-breath technology to assess the \dot{V}_{O_2} response to cycle ergometer work that fluctuated continuously in a sinusoidal manner for six different time intervals through a range of work rates between 25 W and ~80% GET (i.e., intensities that spanned most of the moderate domain) and found a \dot{V}_{O_2} response profile that was sinusoidal and of equal frequency throughout (half-time of ~34 s). This indicates first-order response characteristics and contradicts the earlier work-to-work findings. Later that year, researchers from the same group employed protocols that were similar to those of Di Prampero *et al.* (1970) and Davies *et al.* (1972), and found invariant \dot{V}_{O_2} kinetics for transitions that spanned from rest to cycling at “just-below” GET at 60 rev·min⁻¹ and 25 W cycling at 40 rev·min⁻¹ to the same sub-GET workload at 80 rev·min⁻¹; however, a transition from 25 W cycling at 60 rev·min⁻¹ to the same sub-GET workload at 60 rev·min⁻¹ was “barely” (half-time 35 v. 30 s), but significantly slower compared to the other work-to-work transition (Diamond *et al.*, 1977). Diamond *et al.* (1977) discounted this small variation and suggested dynamic system linearity throughout the moderate domain; specifically, a half-time of ~30-35 s for all transitions to exercise below GET regardless of whether the transition was initiated from rest or light work, and also irrespective of pedal cadence. They also challenged previous speculation that full transitions should be slower due to the confounding influence of venous O₂ stores (Di Prampero *et al.*, 1970; Davies *et al.*, 1972). Specifically, they suggest that any dissociation between muscle and pulmonary \dot{V}_{O_2} due to desaturation of venous blood haemoglobin and active muscle myoglobin would be responsible, at most, for a three-second increase of \dot{V}_{O_2} half-time (Diamond *et al.*, 1977).

In 1982, Hughson and Morrissey attempted to reconcile the previous contradictory findings by characterising the \dot{V}_{O_2} time course during full and work-to-work transitions with parameters derived from monoexponential nonlinear least-squares curve fitting (Hughson

and Morrissey, 1982). These authors suggested that a computer-derived fit would eliminate bias that may have influenced prior work-to-work characterisations that were based upon estimation of a rate constant from visual inspection (e.g., Di Prampero *et al.*, 1970; Davies *et al.*, 1972; Diamond *et al.*, 1977). They also included a time delay in their model so that the initial manifestation of the exponential was not constrained to the initiation point of exercise, and further improved the model fit by eliminating the first 15 seconds of data to prevent cardiodynamic contamination. The findings of Diamond *et al.* (1977) were based upon parameters revealed by a fitting procedure that did not discriminate this confounding aspect of the response.

Hughson and Morrissey's protocols included a full transition within the moderate domain (rest to 80% GET) and transitions of similar magnitude within that domain's lower and upper region (rest to 40% GET and 40% GET to 80% GET, respectively). They also included a more protracted work-to-work transition that spanned from moderate to heavy exercise (40% GET to 120% GET) within their methodology. The authors used both the time constant and the sum of time constant and time delay (i.e., the 'mean response time;' MRT) determined by the model to characterise the rate of \dot{V}_{O_2} change during each response. Their results are illustrated in Figure 2.3.

Hughson and Morrissey resolved the previous conflict by finding both conclusions incorrect! Surprisingly, they observed *slower* \dot{V}_{O_2} kinetics during transitions within the upper compared to lower region of the moderate domain and an even more marked slowing when the transition within the upper region continued to the supra-GET intensity. However, the latter finding must be interpreted with caution because it is based upon time course parameters revealed by fitting a single exponential function to the entire response so

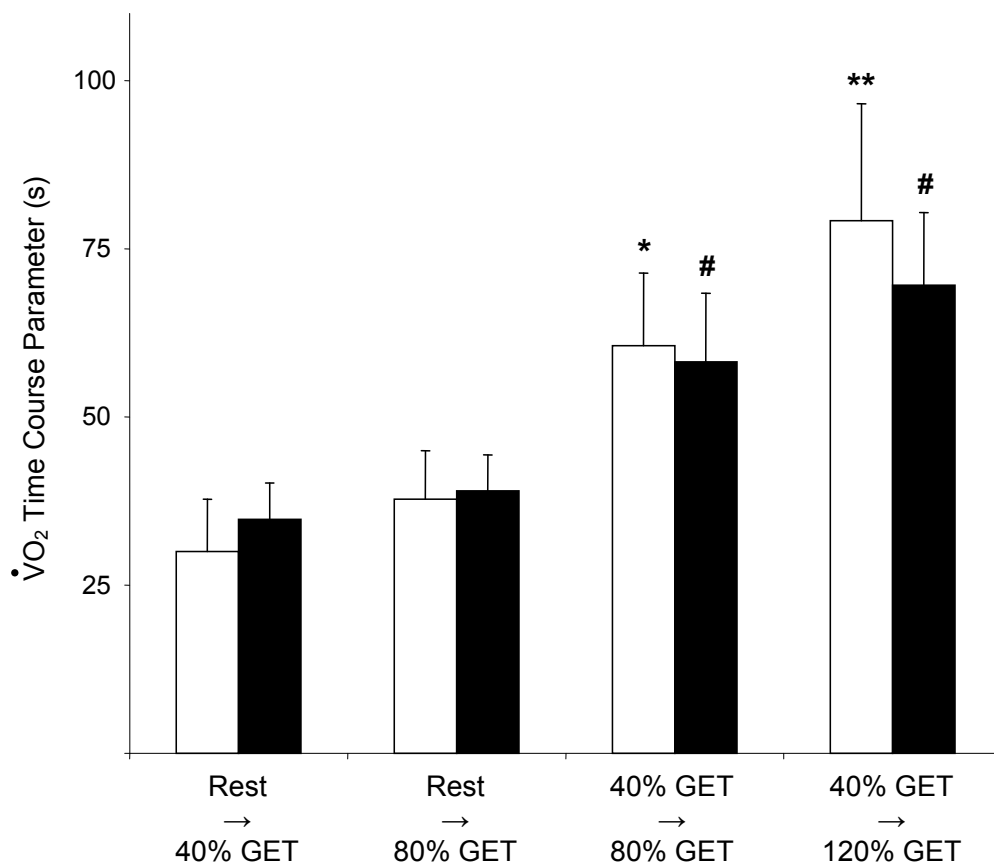

Figure 2.3: \dot{V}_{O_2} time course during full and work-to-work transitions. Open bars represent the time constant; closed bars represent the MRT. For time constant comparisons: *Significant difference compared to transition from rest to 40% GET; **Significant difference compared to both transitions from rest. For MRT comparisons: #Significant difference compared to both transitions from rest. In all cases where differences were found, $P < 0.01$. Adapted from Hughson and Morrissey (1982).

it cannot be determined whether the additional slowing occurred due to the presence of a \dot{V}_{O_2} slow component solely or in conjunction with additional sluggishness during phase II. Nevertheless, this should not detract from the key finding of this study; specifically, \dot{V}_{O_2} kinetics is slower in the upper compared to lower region of the moderate domain (i.e., in an intensity range where a single compartment model appears to provide the appropriate method of characterisation).

Nonlinear behaviour in oxidative control

The need for domain-specific stratification of exercise intensity contradicts the notion that linear, first-order control is present throughout the entire range of oxidative capacity. In addition to temporal- and amplitude-based nonlinearity attributable to a slow component (Whipp and Wasserman, 1972; Linnarsson, 1974; Barstow and Mole, 1991), two other departures from first-order behaviour have been reported for exercise above the GET in subsequent investigations: G_p has been shown to be less for cycle ergometry above compared to below CP (Wilkerson *et al.*, 2004c) and although equivocal findings exist on a study-by-study basis, an analysis of pooled data from 25 investigations revealed that τ_p was greater for heavy/severe compared to moderate cycle and treadmill exercise (e.g., 23% longer during cycling; $n = 127$) (Poole and Jones, 2005). Furthermore, the discovery of slower \dot{V}_{O_2} kinetics for transitions in the upper compared to lower region of the moderate domain (Hughson and Morrissey, 1982) indicates that nonlinear behaviour might be manifest below GET, as well (see also Koppo *et al.*, 2004).

Mechanistic bases for nonlinear behaviour in oxidative control

While subsequent studies confirmed the initial exponential rise in \dot{V}_{O_2} at exercise onset that was forwarded by Henry (1951), the limiting factor he implicated (the provision of oxidizable metabolic substrate within mitochondria) has yet to receive universal support. An exponential process is characterised by an instantaneous rate of change proportional in magnitude to how far the response is from fruition (i.e., the error signal) at any point during its progression (Whipp and Rossiter, 2005; see Figure 1.1). A system that is regulated in this manner could be rate limited by feedback or feed-forward control from any of its components. Nonlinear behaviour of the system as a whole could, therefore, be explained by nonlinear behaviour of a critical rate modulator. In addition, the locus of control might

change over the course of the system's range of capacity if nonlinear response characteristics of an operand that responded linearly at lower levels of turnover became manifest when activation frequency increased. In addition, an intervention could shift the locus of limitation by preferentially dampening the response of an operand that was not the rate modulator under normal circumstances.

To exemplify these theoretical constructs, consider the input/output relationships depicted in Figure 2.4 (reactants A, B and C; size indicates relative capacity to respond). If under low-input conditions (Equation 1), reactant B is the critical rate modulator, a proportionate increase of output compared to input (i.e., a linear response) is established at higher levels of activation (Equation 2) as long as reactant B can respond linearly to the increased rate of turnover. However, a nonlinear response by reactant B will result in nonlinear behaviour of the system as a whole (Equation 3). Furthermore, if reactant C lost the ability to respond in a linear manner at higher levels of activation, the locus of limitation could shift to this operand if reactant B was still able to formulate a linear response within this domain (Equation 4). Similarly, an intervention that dramatically reduced the capacity of reactant C could also shift the locus of rate limitation away from reactant B (Equation 5). However, these similar alterations of control would have dramatically different implications. In the former case, reactants B and C would be considered dual rate modulators, each in relation to a specific intensity domain, whereas in the latter case, reactant C would not be considered as such because it only served to rate limit under atypical circumstances.

Equation 1 (low input; B = critical rate modulator):

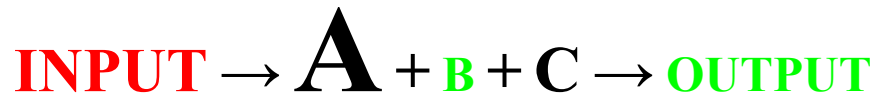

Equation 2 (higher input with linear response attributable to reactant B):



Equation 3 (higher input with nonlinear response attributable to reactant B):



Equation 4 (nonlinear response attributable to domain-specific shift to reactant C):



Equation 5 (nonlinear response attributable to intervention-induced shift of modulation to reactant C):



Figure 2.4: Schematic illustration of an input/output system comprising three reactants (A, B and C) with differing capacities to respond (indicated by font size). Under low-input conditions (Equation 1), reactant B is the critical rate modulator (notice smaller size of “B” v. both “A” and “C,” and similar size of “B” v. “OUTPUT”). At higher levels of activation (Equation 2; see size of “INPUT”), a linear response (proportional increase of “OUTPUT” v. “INPUT”) is established as long as reactant B can respond linearly (notice proportional increase in size of “B” and “INPUT”). However, a nonlinear response by reactant B (Equation 3; “B” increases less than “INPUT”) will result in nonlinear behaviour of the system as a whole (“OUTPUT” increase according to “B” and not “INPUT”). A nonlinear response is also present despite the potential for a linear response by B if another reactant loses the ability to respond linearly at higher levels of activation (domain specifically) or because of an intervention that reduces its capacity to respond (notice “C” in Equations 4 and 5, respectively). See text for practical implications.

Potential determinants of oxidative control

The resynthesis of ATP via cellular oxidation conforms to the following equation:

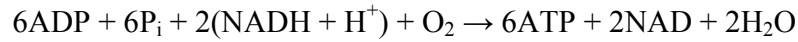

Therefore, when mitochondrial respiratory activity (i.e., ATP hydrolysis; the oxidative system input) increases at exercise onset, oxidative response progression (i.e., as indicated by \dot{V}_{O_2} , which can, therefore, be considered to reflect the system output) depends not only on the provision of oxidizable substrate (i.e., the cellular redox potential; $[\text{NADH}]/[\text{NAD}^+]$) as proposed by Henry (1951), but also on the phosphorylation potential ($[\text{ATP}]/[\text{ADP}] \times [\text{P}_i]$) (Wilson, 1994; Rossiter *et al.*, 2005) and/or the availability of O_2 at the sites of oxidation (Tschakovsky and Hughson, 1999; Hughson, 2005). This means that the limitation to \dot{V}_{O_2} kinetics could also be located outside the cell; specifically, at any point in the O_2 transport cascade, which includes both convective O_2 delivery from atmosphere to active muscle (dependent on haemoglobin concentration, pulmonary diffusion, cardiac output and distribution of blood flow within muscle) and diffusive O_2 conductance from capillary to mitochondria (a function of the concentration gradient for O_2 movement across the capillary wall).

Oxidative control by convective/diffusive O_2 conductance

To explain their unexpected finding, Hughson and Morrissey (1982) suggested that the kinetics of convective O_2 delivery might have been responsible for the nonlinear behaviour they observed. Specifically, they compared HR kinetics for the full and work-to-work transitions and found that the very rapid increase that was present in the rest-to-work adaptation was slowed when the transition was initiated from work. However, a precise

quantification of this slowing and, more importantly, statistical proof of its association with slower work-to-work \dot{V}_{O_2} kinetics (i.e., a positive correlation between the change in HR τ and change in \dot{V}_{O_2} τ for work-to-work compared to full transitions) could not be established because individual response variability precluded kinetics analysis of HR. Therefore, their speculation was based solely on visual inspection of the data and the prior report of a lengthened cardiac output time constant during work-to-work compared to rest-to-work transitions in non-anesthetized dogs during treadmill exercise (Versteeg *et al.*, 1981).

Hughson and Morrissey's speculation was bolstered in 1991 when Hughson and two other researchers analysed autonomic control of heart rate during cycle ergometer exercise (Yamamoto *et al.*, 1991). These researchers used heart rate variability as indicated by coarse-graining spectral analysis to determine the relative contributions of parasympathetic and sympathetic nervous influence on the sinoatrial node during three-minute ramp transitions to constant-load exercise of various submaximal intensities (20 W or 30, 60, 90, 100 and 110% GET) and found that parasympathetic activity decreased progressively from rest to ~60% GET while sympathetic activity increased when intensity exceeded the GET. Given that the cardio-acceleratory stimulus derived from the removal of vagal tone is faster acting compared to sympathetic activation (Rowell and O'Leary, 1990), this would imply a biphasic HR response with breakpoint between 60-100% GET that could explain their previous findings of slower \dot{V}_{O_2} kinetics.

If the shift from parasympathetic to sympathetic HR adaptation is responsible for slower \dot{V}_{O_2} kinetics during work-to-work transitions (Hughson and Morrissey, 1982; Hughson and Morrissey, 1983), one of two mechanistic suppositions can be drawn. O_2 delivery might be

the critical reactant that rate modulates all metabolic transitions under normal circumstances (see oxidative ATP resynthesis equation on p. 40). This would explain a shift from linearity when HR (and, by extension, tissue oxygenation) no longer responded as rapidly (see Figure 2.4; reactant B in Equations 1, 2 and 3). Alternatively, another reactant serving as the locus of limitation (the redox or phosphorylation potential, for example) could be supplanted at higher intensities when O₂-delivery is hindered by the altered HR response (see Figure 2.4; reactant C compared to B in Equation 4). The latter would indicate that the rate limitation of cellular oxidation would be domain specific; for example, a metabolic inertia of intracellular origin below GET and a superimposed additional systemic limitation attributable to O₂ delivery above it.

Control of oxidative function by O₂ availability

There is on-going debate concerning the degree of influence that O₂ exerts on the \dot{V}_{O_2} adaptation during transitions to higher metabolic rates (Grassi, 2005; Hughson, 2005; Poole *et al.*, 2008). As the terminus to electron transfer, O₂ plays a pivotal role when electron movement in the oxidative phosphorylation pathway is used to satisfy energetic demand. However, it cannot be implicated as the critical rate modulator (either overall or domain specific as explained above) unless predictable consequences accompany both a decrease *and* increase in its availability. For example, interventions and conditions that restrict tissue oxygenation including hypoxic gas inspiration (Engelen *et al.*, 1996), supine leg cycling (Koga *et al.*, 1999; Denis and Perrey, 2006; Jones *et al.*, 2006), arm ergometry with the exercising limbs above heart level (Koppo and Bouckaert, 2005), β -adrenergic receptor blockade (Hughson, 1984) and cardiovascular disease-related impairment (Poole *et al.*, 2005) have been shown to slow \dot{V}_{O_2} kinetics. Although tissue blood flow was not measured to confirm reduced tissue oxygenation in these studies, collectively, the findings suggest

that there might be circumstances where alterations in O_2 delivery can contribute to slowed \dot{V}_{O_2} kinetics. However, as a stand-alone observation, this does not implicate O_2 as the critical rate modulator because these manipulations/conditions could exert their effect by completely exhausting what could be considered a ‘reserve capacity’ of O_2 availability as it functions in a non-limiting role. For example, in Figure 2.4; Equation 5, an intervention has slowed the response kinetics of a non-limiting operand (reactant C) to a sufficient degree so that the control typically wielded by the critical rate modulator (reactant B) is circumvented. Consequently, reactant C is responsible for metabolic control under these circumstances. However, it is important to note that it would *not* be considered the critical rate modulator because when the system is exerting ‘normal’ control, it is not responsible for setting the time course. This is confirmed when Equation 1 in Figure 2.4 is reconsidered; specifically, the capacity of reactant C can be enhanced within this model without a stimulatory effect on system output.

If the slowed \dot{V}_{O_2} kinetics under circumstances where O_2 delivery is sufficiently compromised represents a shift away from the normal locus of control, it is easy to see how a mistaken conclusion (the designation of O_2 as the critical rate modulator under ‘normal’ circumstances) can be drawn. However, this issue is easily resolved. If O_2 is the critical rate-limiting reactant in the oxidative ATP resynthesis equation on p. 40, *increasing* its presence should *speed* the \dot{V}_{O_2} time course just like decreasing its availability can slow it. For example, both inhibitory *and* stimulatory manipulations of reactant B (the critical rate modulator) in Equation 1 of Figure 2.4 would be directly mirrored in system output, whereas facilitation of reactant C would not enhance reaction turnover rate, even though its severe restriction in Equation 5 did serve to dampen it.

Increasing O₂ availability: the prior-exercise effect

A number of experimental interventions have been used to study the effect of increased O₂ availability on \dot{V}_{O_2} kinetics. By far, the one that has provided the most insight is also the one that receives widespread interest for a different reason. Within the sport-science community, 'warm-up' exercise has been studied extensively because of the desire to find the optimal strategy to prepare for and optimise athletic performance. Interestingly, this investigative impetus has also led to a number of important findings with respect to metabolic control. A timeline documenting the most significant ones follows:

- 1996 – Extending previous findings from seven years prior, Gerbino *et al.* showed that prior high-intensity leg cycle exercise (six minutes at 50%Δ) accelerated the overall \dot{V}_{O_2} time course during subsequent leg cycling at the same intensity performed after six minutes of rest; however, prior moderate-intensity cycling (80% GET) did not (Gerbino *et al.*, 1996). These researchers also showed that moderate-intensity cycling (80% GET) could not be altered in a similar way regardless of the intensity of the priming bout. Gerbino *et al.* (1996) viewed this as confirmation that an O₂-delivery limitation was present above, but not below the GET, and suggested that this restriction was removed by the residual effects of high-, but not moderate-intensity priming. This speculation was based upon the fact that high-intensity exercise causes an elevation of blood [lactate] that would still be present at subsequent-bout onset and this residual acidosis should be associated with vasodilation and a Bohr (i.e., rightward) shift of the oxyhaemoglobin dissociation curve (i.e., a change that facilitates the release of O₂ from haemoglobin in tissues). The accelerated oxidative adaptation that was observed in the primed bout was also accompanied by a significant reduction in blood lactate accumulation and a

decreased fall in blood pH, with the corresponding reduction in \dot{V}_{CO_2} that would be expected in association with these changes.

- 2000 – Recognising that the acceleration reported by Gerbino *et al.* (1996) was determined from a time course parameter (the ‘effective’ $\dot{V}_{O_2} \tau$) that was revealed by a single exponential fit, Burnley *et al.* (2000) replicated their study and used more complex modelling procedures to characterise what should be a multiple component response during high-intensity exercise. These researchers verified all of the previous findings and also showed that the overall acceleration that was reported was actually due to an increase in the absolute \dot{V}_{O_2} amplitude that was attained upon completion of phase II in conjunction with a decreased \dot{V}_{O_2} slow component (i.e., the overall response became closer to first order). However, no acceleration of the phase II \dot{V}_{O_2} time course (i.e., no reduction of τ_p) was observed.
- 2001 – To provide further insight into their findings, Burnley *et al.* (2001) applied the same experimental intervention to elicit the prior-exercise effect; however, in this case, they allowed sufficient time (12 minutes) for the restoration of baseline \dot{V}_{O_2} prior to initiating the subsequent bout. This was done to determine whether the priming-induced increase in absolute amplitude upon completion of phase II was an actual increase in phase II amplitude that was masked by the higher initiation point or simply the same response built upon the carryover elevation. Interestingly, they found the former: The fundamental \dot{V}_{O_2} response to exercise was, in fact, greater under these specific circumstances.
- 2002 – To unveil the potential mechanism(s) responsible for the prior exercise effect they had found, Burnley *et al.* (2002b) and Koppo and Bouckaert (2002) each

used passive warming of the active musculature to show that temperature elevation *per se* did not facilitate the same changes. Furthermore, Koga *et al.* (1997) had previously reported a small *increase* of the \dot{V}_{O_2} slow component with passive heating using hot-water-perfused pants. Additionally, Burnley *et al.* (2002b) showed that the prior-exercise effect was still present when the prior bout consisted of multiple sprints that resulted in similar elevation of blood [lactate], but not temperature. Collectively, these findings indicate that the effect should not be considered a ‘warm-up’ if that term is intended to be used in a literal manner. In another study, Burnley *et al.* (2002a) averaged the integrated electromyogram (iEMG) responses of three leg muscles and found that iEMG during the first two minutes of high-intensity cycling was significantly greater after priming. The authors advanced this as evidence that priming altered the motor unit recruitment pattern during subsequent exercise and theorised a shift from delayed-onset to earlier activation. Interestingly, delayed-onset fibre recruitment to account for fatigue had been one of the mechanisms speculated to underpin the \dot{V}_{O_2} slow component during high-intensity exercise (Gaesser and Poole, 1996). Therefore, a priming-induced shift from delayed-onset to earlier recruitment would be consistent with the changes in \dot{V}_{O_2} profile that were observed.

Other investigations that have attempted to link the priming effect with altered motor unit recruitment have returned equivocal findings (see Tables 2.3 and 2.4 below). However, to date, the vast majority of investigations have confirmed that under normal exercise circumstances (i.e., when blood flow is not restricted and/or when \dot{V}_{O_2} kinetics is not unusually slow), the facilitation of \dot{V}_{O_2} kinetics attributable to priming is exclusively amplitude-based (Burnley *et al.*, 2000; Burnley *et al.*, 2001; Koppo and Bouckaert, 2001;

Scheuermann *et al.*, 2001; Burnley *et al.*, 2002a; Burnley *et al.*, 2002b; Wilkerson *et al.*, 2004b; Burnley *et al.*, 2005; Endo *et al.*, 2005; Bailey *et al.*, 2010). The characteristic prior-exercise effect can, therefore, be described as the tendency for prior heavy exercise that results in residual blood lactic acidosis to speed the overall $\dot{V}O_2$ response as a result of an increased primary component amplitude and a reduced amplitude of the $\dot{V}O_2$ slow component, with no change in the primary component time constant (Burnley *et al.*, 2005).

Figure 2.5 depicts this well-established prior-exercise effect.

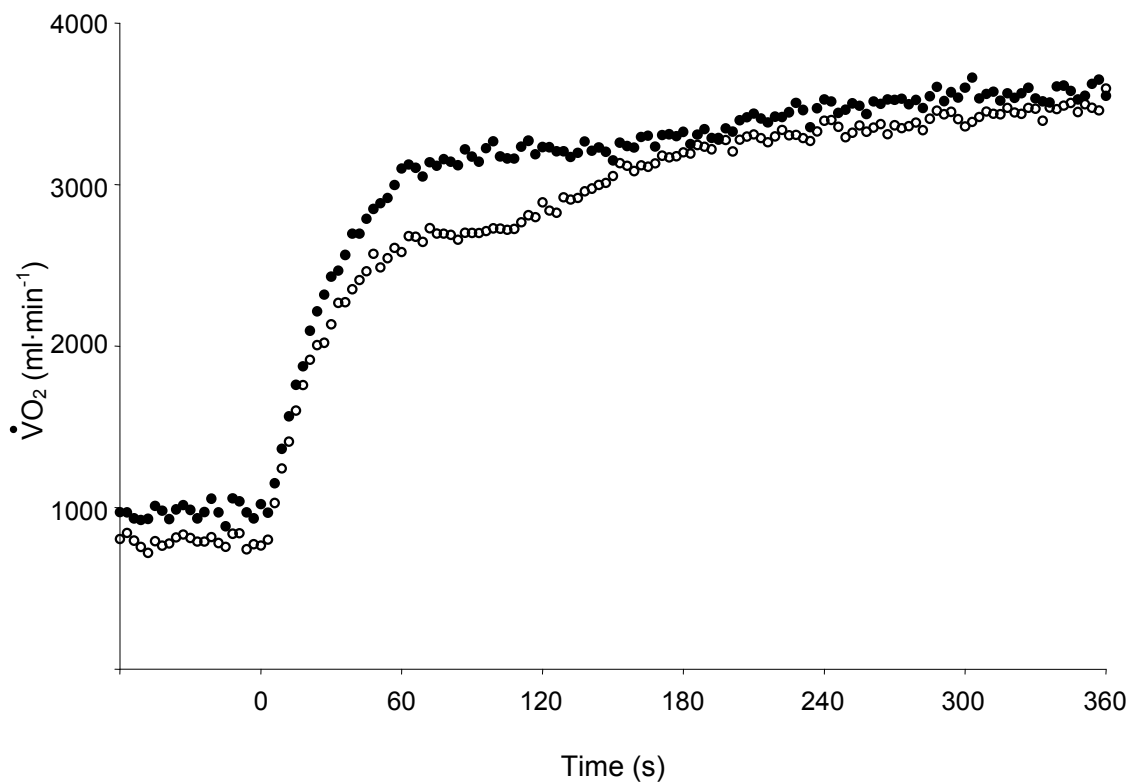

Figure 2.5: The characteristic effect of prior high-intensity priming exercise on $\dot{V}O_2$ kinetics. The τ describing the phase II $\dot{V}O_2$ rise during both the unprimed (open circles) and primed (closed circles) depicted response profiles is the exact same (25 s). However, after priming, the overall oxidative response is facilitated because the primary amplitude is increased and the $\dot{V}O_2$ slow component is reduced.

Although the characteristic prior-exercise effect seems to occur in conjunction with residual blood lactic acidosis, justification for a precise mechanistic link between blood lactate accumulation and the alterations in \dot{V}_{O_2} kinetics that are present following priming is currently lacking (e.g., see Poole *et al.*, 1994). It is, therefore, likely that, in this case, the role of lactate is not a direct one (Burnley *et al.*, 2006). Furthermore, although atypical, there are a number of circumstances where phase II \dot{V}_{O_2} kinetics is accelerated by priming. For example, Jones *et al.* (2006) found that τ_p was reduced from ~ 38 to ~ 24 s during high-intensity cycling in the supine position after a high-intensity priming bout. This speeding was correlated with the extent to which phase II \dot{V}_{O_2} kinetics was slower in the supine compared to upright condition and, after priming, τ_p was no longer significantly different from the upright value (~ 29 s). The authors suggested that due to the supine posture, an O_2 -delivery limitation had been superimposed upon the normal locus of regulation (“intracellular factors”) such that the constraint that was present in the supine bout was negated by priming. Similar results have been reported by Koppo and Bouckaert (2005) for arm crank exercise where priming reduced τ_p during high-intensity exercise above (unprimed, ~ 50 s; primed, ~ 41 s), but not below (~ 36 s for both conditions) the level of the heart. Collectively, these results suggest that when interventions that alter O_2 availability compromise \dot{V}_{O_2} kinetics (e.g., see Equation 5 in Figure 2.4), priming can reduce τ_p . This also appears to be the case when τ_p is unusually long because of specific characteristics of the subjects being tested (e.g., in older adults; DeLorey *et al.*, 2004; Gurd *et al.*, 2009); however, to date, there has been only one report of priming-induced acceleration of phase II \dot{V}_{O_2} kinetics in healthy, young subjects with ‘normal’ τ_p values (τ_p reduced from ~ 29 to ~ 22 s after sprint cycle priming; Tordi *et al.*, 2003). A possible explanation for these aberrant findings is that the subjects studied were trained cyclists ($\dot{V}_{O_{2peak}}$ of ~ 65 ml·kg·min) that were operating at a high percentage of their functional capacity ($\sim 85\%$

$\dot{V}_{O_{2peak}}$; i.e., a work rate that resulted in the attainment of $\sim 97\% \dot{V}_{O_{2peak}}$ after six minutes of exercise) (Tordi *et al.*, 2003). It is possible that \dot{V}_{O_2} kinetics might be particularly sensitive to changes in O_2 availability in this type of subject under these circumstances (Burnley *et al.*, 2005).

The role of O_2 under 'normal' conditions

The fact that an intervention that should enhance both convective and diffusive muscle O_2 delivery does so without shortening τ_p suggests that O_2 is not the critical rate modulator of oxidative function during normal metabolic transitions. Further support for this notion comes from Wilkerson *et al.* (2006), who found that τ_p was not shortened when subjects breathed a hyperoxic gas mixture (50% O_2 in N_2) to increase arterial O_2 content during transitions to moderate (90% GET), severe (70% Δ) or extreme (105% \dot{V}_{O_2} peak) cycle ergometer exercise. Interestingly, this was even the case for one subject who experienced severe exercise-induced arterial hypoxaemia during the high-intensity bouts in the control condition. In another study, Wilkerson *et al.* (2005) showed that a 7% increase in haemoglobin concentration resulting from four weeks of recombinant human erythropoietin treatment also did not serve to accelerate the phase II \dot{V}_{O_2} response. Muscle blood flow was not measured directly in these studies, however, so the results must be interpreted with some degree of caution. For example, there is evidence to suggest that during exercise in hyperoxic conditions, leg blood flow is reduced (Welch *et al.*, 1977). Although not a universal finding (e.g., see Knight *et al.*, 1993), this means that compensatory adjustments might occur to normalise muscle O_2 delivery at different capillary PO_2 values (Poole and Jones, 2005).

In summary, there is evidence to suggest that restricting O_2 availability might sometimes slow the primary $\dot{V}O_2$ response, but increasing its availability cannot accelerate it. This implies that O_2 is not the critical rate modulator but, instead, exerts control only when its reserve capacity is exhausted (i.e., operates in a role similar to reactant C in Figure 2.4). This has led Poole and Jones to characterise oxidative control in accordance with a continuum, as outlined in Figure 2.6 (Poole and Jones, 2005; Poole *et al.*, 2007; Poole *et al.*, 2008). In this schematic, a critical point exists below which O_2 delivery is no longer

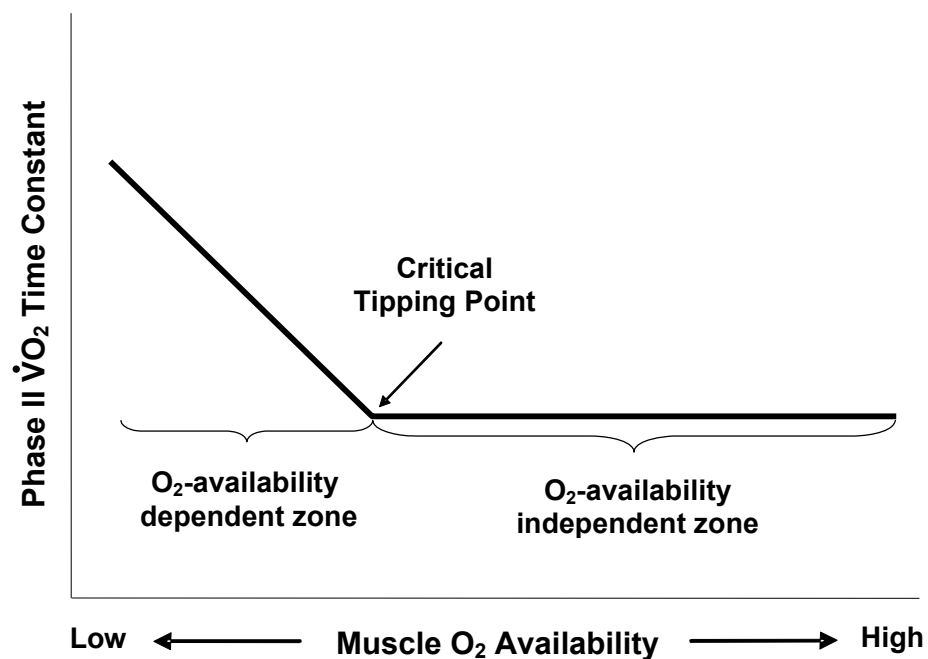

Figure 2.6: Theoretical model depicting the degree of influence O_2 availability plays in setting the phase II $\dot{V}O_2$ time course. Within the O_2 -availability independent zone, the critical rate modulator exerts control; therefore, O_2 availability can be augmented or restricted without altering τ_p . However, once O_2 availability is compromised sufficiently to traverse the tipping point, the critical rate modulator's control is circumvented and τ_p is lengthened according to the degree of O_2 restriction. Adapted from Jones and Poole (2005).

sufficient to maintain \dot{V}_{O_2} kinetics. This divide separates O_2 -delivery independent and dependent zones, and indicates the point at which the critical rate modulator's control is circumvented. Notice that phase II \dot{V}_{O_2} kinetics is slowed (i.e., τ_p is lengthened) only when O_2 delivery is compromised sufficiently to cross this 'tipping point' (i.e., shift control from the critical rate modulator). It is reasonable to assume that considerable inter-individual variation exists with respect to the point of 'normal' function within this range and chronic (e.g., aging, detraining, disease, conditioning) and acute (e.g., exercise modality, body position, vascular occlusion) manipulations should further influence this set-point.

Control of oxidative function by intracellular processes

If normal metabolic transitions are characterised by sufficient O_2 at the sites of oxidation to support the increased electron flow, the finite \dot{V}_{O_2} response (i.e., the fact that muscle O_2 uptake achieves its requisite level in an exponential, as opposed to immediate, square-wave manner) must be attributable to intracellular processes that provide electrons to the transport chain. As indicated by the equation that depicts the resynthesis of ATP via cellular oxidation (see p. 40), these include the cellular redox and phosphorylation potentials (i.e., $[NADH]/[NAD^+]$ and $[ATP]/[ADP] \times [P_i]$, respectively).

Intracellular control – redox potential

The pyruvate dehydrogenase complex (PDC) contains enzymes that reduce NAD^+ to NADH while decarboxylating pyruvate to acetyl-CoA for tricarboxylic acid cycle oxidation. Consequently, this mechanism exerts considerable control over the redox potential within the cell and could be the critical rate modulator within the oxidative chain. However, while pharmacological activation of the PDC has been shown to cause a 'stockpiling' of acetyl groups (Greenhaff *et al.*, 2002) and a reduction in substrate-level

phosphorylation in humans during subsequent exercise (Timmons *et al.*, 1998), further investigation revealed that the source of this facilitation was amplitude-based (i.e., a reduction in the amplitude of the primary \dot{V}_{O_2} response) (Rossiter *et al.*, 2003) and no acceleration of τ_p in either animals (Grassi *et al.*, 2002) or humans (Bangsbo *et al.*, 2002; Rossiter *et al.*, 2003; Jones *et al.*, 2004a) has been found.

Intracellular control – phosphorylation potential

When exercise is initiated, increased contractile-related ATP hydrolysis causes free ADP and P_i concentrations within the cytoplasm to rise. Therefore, it is logical to speculate that ATP regeneration via oxidative phosphorylation within mitochondria could be linked in some way with the phosphorylation potential within the cytoplasm (Chance and Williams, 1955). In addition, ATP hydrolysis in the cytoplasm is effectively buffered by [PCr] degradation such that ATP concentration is closely maintained (Rossiter *et al.*, 2002b). However, this tight control would be short-lived were it not for an increased contribution from oxidative phosphorylation, so feedback control of mitochondrial respiration from the breakdown of [PCr] also has a strong theoretical basis (Saks *et al.*, 2001; Walsh *et al.*, 2001). Interestingly, PCr/Cr phosphate exchange also provides a mechanism that allows the spatial divide between cytoplasm and mitochondria to be traversed (Bessman and Geiger, 1981). Therefore, it is not surprising that this mechanism has been implicated as a potential key player in metabolic control (Rossiter *et al.*, 2005).

The creatine phosphate shuttle

PCr hydrolysis in the cytoplasm is functionally linked to oxidative phosphorylation in mitochondria by a mechanism termed the creatine phosphate shuttle (Bessman and Geiger, 1981). This system operates through the actions of two isoforms of creatine kinase – one

that exists in the cytoplasm and another that resides within the intermembranous mitochondrial space. Creatine phosphate shuttling and the corresponding control of cellular respiration have been suggested to occur as follows:

- 1.) Free energy to drive the contractile process is liberated from ATP via hydrolysis by the ATPase enzymes of contraction ($\text{ATP} + \text{H}_2\text{O} \rightarrow \text{ADP} + \text{P}_i + \text{Free Energy}$).
- 2.) Cytoplasmic creatine kinase rephosphorylates ADP at the expense of PCr ($\text{ADP} + \text{PCr} \rightarrow \text{ATP} + \text{Cr}$).
- 3.) Newly formed Cr moves readily from cytoplasm to intermembranous mitochondrial space.
- 4.) Mitochondrial creatine kinase rephosphorylates Cr at the expense of ATP ($\text{Cr} + \text{ATP} \rightarrow \text{ADP} + \text{PCr}$) that is provided by oxidative phosphorylation.
- 5.) Newly formed PCr moves readily from intermembranous mitochondrial space back to cytoplasm to complete the cycle.
- 6.) Intermembranous ADP stimulates transmembrane ADP/ATP exchange (translocation) so that ADP entrance into and ATP exit from the inner mitochondrial membrane is facilitated.
- 7.) Increased ATP in intermembranous space satisfies mitochondrial creatine kinase reaction.
- 8.) Increased ADP in inner membrane stimulates electron transport and the rephosphorylation of ADP via oxidative phosphorylation. O_2 uptake increases accordingly.

The creatine phosphate shuttle hypothesis was originally forwarded by Bessman and Geiger (1981) and further elucidated in subsequent years by investigations that confirmed a direct linkage between [PCr] breakdown and O_2 uptake. For example, Mahler (1985)

studied isolated frog sartorius muscle and found [PCr] kinetics that matched that of muscle \dot{V}_{O_2} , with each response demonstrating linear, first-order control. Similarly, Rossiter *et al.* (1999, 2002b) used ^{31}P phosphorous nuclear magnetic resonance spectroscopy (^{31}P -MRS) to estimate the dynamics of intramuscular [PCr] simultaneously with \dot{V}_{O_2} measurement in humans performing both moderate and heavy on- and off-exercise transients and returned similar findings. Specifically, when a square-wave alteration in metabolic demand is encountered, the exponential change in \dot{V}_{O_2} is directly mirrored by an exponential change in [PCr] such that the τ describing each response is similar. Furthermore, observations of a [PCr] slow component during heavy exercise (Rossiter *et al.*, 2001; Rossiter *et al.*, 2002a; Jones *et al.*, 2008) also indicate agreement between the [PCr] and \dot{V}_{O_2} profiles. These findings cohere with the earlier work of Meyer, who used similar technology to study [PCr] degradation in response to different stimulation/recovery cycles during electrically-induced contractions in anaesthetised rats and observed a [PCr] τ that was invariant across a range of stimulation rates and also at the onset and offset of stimulation (i.e., a [PCr] response that obeyed the law of superposition) (Meyer, 1988). This prompted him to advance a model of respiratory control based on a simple electrical analogue for a linear, first-order system transformed to accommodate chemical components (see Figure 2.7).

The electrical analogue model of respiratory control

In Meyer's electrical analogue model of respiratory control, the current (I_{cy}) represents the rate of cytoplasmic ATP hydrolysis, the voltage (V_o) represents the associated free energy liberation and V_b represents the free energy potential that is available due to the proton electrochemical gradient established within the mitochondria. Furthermore, the resistor (R_m) is a function of mitochondrial volume and density, and the current associated with the

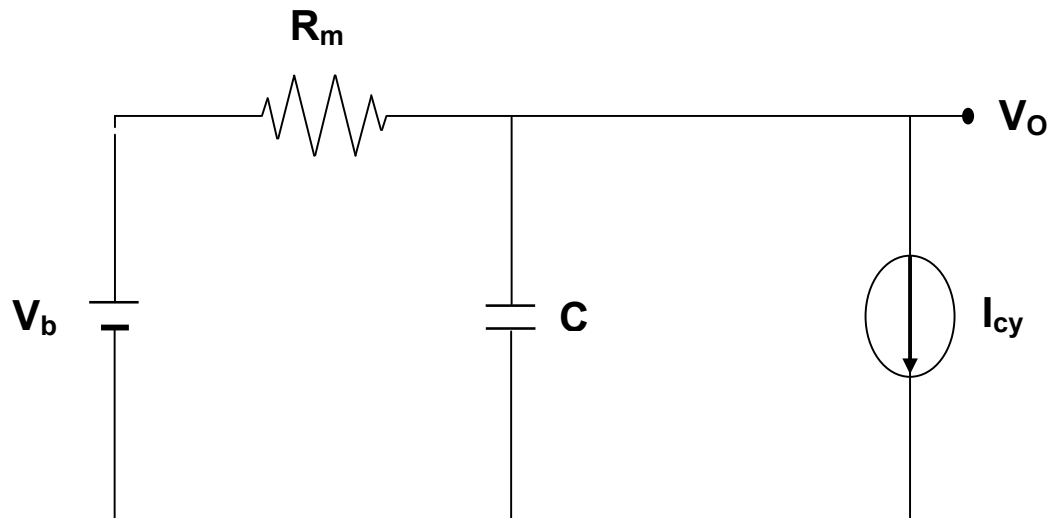

Figure 2.7: The electrical analogue model of respiratory control proposed by Meyer. Within this schema, the creatine kinase reaction acts as a chemical capacitor that is responsible for a linear, first-order oxidative response. See text for further details. Adapted from Meyer (1988).

latter represents the rate of oxidative phosphorylation that characterises the response. Finally, the capacitance (C) associated with this circuit is due to the creatine kinase reaction and, consequently, $[PCr]$ is analogous to the stored charge on a capacitor. Therefore, according to this model, the τ for the exponential fall in $[PCr]$ and associated rise in oxidative phosphorylation (i.e., $\dot{V}O_2$) at exercise onset depends upon mitochondrial resistance and metabolic capacitance. This is supported by reports that endurance training that increases citrate synthase activity (i.e., decreases mitochondrial resistance) and depletion of total creatine content (and, therefore, metabolic capacitance) both accelerate $[PCr]$ kinetics in rat muscle (Meyer *et al.*, 1989; Paganini *et al.*, 1997).

If respiratory control is established in the manner suggested by Meyer's analogue model, predictable changes should accompany alterations of creatine kinase function and/or total

[PCr] content within the system. For example, reduced [PCr] should decrease circuit capacitance and cause mitochondrial respiration to respond at a more rapid rate. Interestingly, it has been shown that acute creatine kinase inhibition resulted in faster intracellular PO_2 kinetics in isolated *Xenopus* myocytes (Kindig *et al.*, 2005). This has resonance because similar facilitation would equate to faster \dot{V}_{O_2} kinetics in intact muscle. (Note: Results from this study also illustrate the dual role of the creatine kinase reaction in serving to modulate metabolic transitions as peak tetanic tension was reduced and fatiguability increased during the bout of repetitive contractions when creatine kinase was inhibited. This was likely due to the absence of creatine kinase to buffer the fall in ATP that is present at exercise onset (Kindig *et al.*, 2005).) Conversely, Jones *et al.* (2009) showed that increasing muscle total creatine content via dietary creatine supplementation slowed [PCr] kinetics across transitions from rest to both moderate- and high-intensity knee-extension exercise (Jones *et al.*, 2009). This is also consistent with Meyer's model because increased creatine content would result in increased metabolic capacitance.

The work-to-work exercise effect*Work-to-work exercise transitions revisited*

Work-to-work transitions were revisited in 1987 when modelling specialist R. Hugh Morton recognised the findings from the Whipp group (an unchanged \dot{V}_{O_2} τ for work-to-work compared to full transitions: Casaburi *et al.*, 1977; Diamond *et al.*, 1977), the Di Prampero group (faster \dot{V}_{O_2} kinetics from an elevated baseline: Di Prampero *et al.*, 1970; Davies *et al.*, 1972) and Hughson and Morrissey (a delayed work-to-work response: Hughson and Morrissey, 1982; Hughson and Morrissey, 1983) and suggested a number of methodological considerations that might account for the ambiguity (Morton, 1987). Specifically, he cites the limited intensity ranges for the on-transients studied, the omission of off-transient data and the modelling procedures that were employed as possible areas of concern. Morton (1987) believes that sufficient empirical evidence exists to accept the assumption of an analogue model of respiratory control where the instantaneous rate of \dot{V}_{O_2} increase is proportional to the difference between instantaneous \dot{V}_{O_2} and that which is required for the imposed workload. However, he suggests that acceptance of this model and use of the corresponding exponential equation (i.e., one that describes first-order behaviour) when testing the presence of first-order behaviour is inappropriate. Morton also points out that the incorporation of a time delay in the exponential model can be justified only by “statistical convenience.” For example, he uses data from Hughson and Morrissey (1982, 1983) (time delay estimates for the \dot{V}_{O_2} , \dot{V}_{CO_2} and ventilatory responses that ranged from -11.4 to +42.0 s with standard errors up to ± 36.6 s) to determine that a null hypothesis of no delay could be rejected at the 5% level in only one of 23 cases. In conjunction with results from other studies, he finds this to be insufficient evidence to justify inclusion of such a term even though he does recognise a conceptual framework for

a response delay based on the muscle/mouth spatial divide (see Whipp (2009) and Stirling and Zakythinaki (2009) for a recent debate that revisited this issue).

Morton's exposé was designed to increase awareness of potential confounding factors so that future work-to-work investigations would yield more reliable conclusions. A new generation of studies designed to elucidate the issue would follow. The first was by the Di Prampero group, who changed key aspects of their previous methodology in an attempt to clear up the confusion (Di Prampero *et al.*, 1989). Specifically, they eschewed mixing chamber collection and utilised the same breath-by-breath technology that the Whipp group (but not Hughson and Morrissey) had employed in their previous work. In addition, they recognised that the data from both other groups were obtained during cycle ergometry as opposed to the forms of exercise that they had studied (stepping and treadmill). Consequently, in this investigation, they analysed both stepping and cycling. Finally, they addressed the concerns of Morton by also analysing off-transients and employing modelling techniques that characterised the entire on-transient response from the onset of work without the assumption of exponentiality. Unfortunately, while more objective, this form of modelling is also necessarily vague.

The protocols of Di Prampero *et al.* (1989) included two full transitions (from rest to ~20% and ~60% $\dot{V}_{O_{2max}}$), two work-to-work transitions (from 20-65% $\dot{V}_{O_{2max}}$ to 40-85% $\dot{V}_{O_{2max}}$; most transitions spanning \dot{V}_{O_2} increments of ~20-40% $\dot{V}_{O_{2max}}$) and corresponding off transitions that mirrored the on-transients. To characterise their responses, they determined steady state \dot{V}_{O_2} values for each distinct level of metabolic activity and used these to integrate the O_2 deficit and corresponding half-time of the response. In addition to providing a characterisation not based on an exponential assumption, this method obviated

the need to remove the cardiodynamic phase from consideration and also eradicated controversy surrounding delay-term inclusion.

Interestingly, the results from Di Prampero *et al.* (1989) suggested a modality-distinct work-to-work effect. Specifically, they found a greater O₂ deficit when a workload increment was encountered from an elevated baseline during cycling, but not stepping exercise. Their analyses of \dot{V}_{O_2} half-time showed a similar pattern – a progressive slowing with increasing baseline during cycle transitions and faster kinetics for transitions from mid-range (15-30% $\dot{V}_{O_{2max}}$) compared to rest or higher baselines (40% $\dot{V}_{O_{2max}}$) during stepping. Their interpretation was that faster work-to-work kinetics will prevail when the accelerating influence of muscle O₂-store depletion outstrips the slowing created by a contribution from anaerobic glycolysis while a slower response indicates a reversal of this balance. They cite a much steeper $\Delta\text{blood [lactate]}/\Delta\dot{V}_{O_2}$ slope for cycling compared to stepping to support this contention.

The observations by Di Prampero *et al.* (1989) cohere with those of Hughson and Morrissey (1982) for cycle exercise while also supporting the previous findings (at least for transitions from mid-range baselines) for stepping from their lab. However, it's important to note that exercise intensity domain was not controlled for in this study. Consequently, a \dot{V}_{O_2} slow component was likely present during the higher transitions. Furthermore, the same absolute increment in \dot{V}_{O_2} during cycling and stepping might not have represented the same relative change in metabolic capacity. The different blood [lactate] profiles they report for cycling compared to stepping is consistent with this suggestion.

If the analogue model of respiratory control is correct and critical rate modulation of \dot{V}_{O_2} kinetics under normal circumstances is principally established via creatine-kinase reaction feedback control (Meyer, 1988), the mechanistic basis of the work-to-work effect shown by Hughson and Morrissey (1982) and supported by Di Prampero *et al.* (1989) must be reconsidered. If an O_2 -delivery limitation was responsible for slower work-to-work kinetics, it would not represent simple compromise of the critical rate modulator as suggested (Hughson and Morrissey, 1982; Hughson and Morrissey, 1983). Instead, circumvention of the controller (i.e., compromise of O_2 delivery to a sufficient degree such that creatine kinase-determined ADP phosphorylation in mitochondria cannot be matched by O_2 binding at cytochrome *c* oxidase; see Figure 2.4; reactant C compared to B in Equation 5) or alteration of its modulation (e.g., through adjustment of the cellular energetic state; i.e., ATP + [PCr]) would be implicated.

In 2001, a publication by Brittain *et al.* (2001) served as the genesis for a new generation of investigations designed to assess the effect of an elevated baseline on \dot{V}_{O_2} kinetics. Recognising the disparate findings from earlier research with respect to moderate domain dynamic linearity, these scientists set out to resolve the issue by determining both on- and off-transient kinetics during transitions to and from 90% GET that were completed in either one full or two half steps. Improving on the measurement technology utilised by Hughson and Morrissey (1982) while employing similar modelling procedures, Brittain *et al.* (2001) used breath-by breath analysis of multiple like-transitions to improve confidence in parameter estimation and confirmed previous single-transition findings by that group; specifically, the presence of slower on-transient kinetics in the upper compared to lower moderate region ($\dot{V}_{O_2} \tau$, ~40 and ~25 s, respectively). However, in contrast to Hughson and Morrissey (1982), they also reported a τ value that was significantly different from both

(~32 s) when the increment was completed in one full step. On-transient MRT values followed a similar trend, although significance was not attained in any case (resonant with the findings of Diamond *et al.* (1977), who derived their half-time estimates without phase I removal) and off-transient kinetics (both τ and MRT) was invariant, regardless of the transition that elicited the response. In addition, the on-response G was different for all three transitions (lowest in the lower region, highest in the upper region and intermediate for the full transition), which was an unexpected and novel finding.

Work-to-work effect: implications for metabolic control

Brittain *et al.* (2001) confirmed that the \dot{V}_{O_2} response is not dynamically linear, even below GET. However, the methodology they employed did not allow for the identification of contributory mechanisms. Nevertheless, these researchers advanced a theory that has received considerable attention in subsequent work. Brittain *et al.* (2001) suggested that nonlinear \dot{V}_{O_2} kinetics in the moderate domain might be attributed to diverse response characteristics of different segments of the fibre recruitment pool. Human skeletal muscle comprises fibres with distinctly different bioenergetic properties that are recruited in a hierarchical manner depending primarily on the intensity of the contractile activity taking place (Henneman *et al.*, 1965). By its very nature, the pulmonary \dot{V}_{O_2} signal will homogenise any oxidative response diversity within an activated pool during a transition that requires input from a heterogeneous fibre population. However, if a similar transition is completed in two discrete steps, response characteristics that would more closely reflect those displayed by fibres at opposite ends of the pool would be unveiled.

Muscle fibre type and motor unit activation

According to the well-established size principle advanced by Henneman *et al.* (1965), smaller motor units have lower activation thresholds and are, therefore, recruited when a minimal central nervous drive for activation is present (e.g., when contractile intensity is low during exercise). These motor units contain type I (slow twitch) muscle fibres that generally have greater mitochondrial density and also have more myoglobin content, higher capillarity and greater capacity to resynthesise ATP via oxidative phosphorylation (Gollnick *et al.*, 1972; Gollnick *et al.*, 1973; Essen *et al.*, 1975; Elder *et al.*, 1982; Nemeth and Lowery, 1984). At the other end of the spectrum, type IIX fibres that have limited oxidative potential are only activated at high intensity when a greater drive through the recruitment hierarchy is required. Type IIA fibres are situated intermediate to these extremes, although this three-tier delineation system is presumed to oversimplify what are likely more gradual gradations from one end of the spectrum to the other (Bottinelli and Reggiani, 2000). It is also important to recognise that in addition to the quantity of motor units being recruited, force gradation in a contracting muscle is also a function of the frequency of action potential discharge (rate coding) within recruited motor units. However, when different muscles of similar fibre type are compared, the larger muscles that perform gross movements of the limbs (e.g., those that would be predominantly involved in conventional exercise activities like cycling) appear to rely more on recruitment as the primary means for increasing force development (Seki and Narusawa, 1996).

Characteristics of muscle fibre types: in-vitro investigations

In-vitro studies of animal muscle provide evidence that fibres at opposite ends of the recruitment hierarchy evince marked differences in the ability to receive and utilise O₂. For example, phosphorescence quenching that allows high-fidelity determination of

microvascular O_2 pressure (P_{mvO_2}) has been used to assess the dynamic balance between O_2 delivery and O_2 utilisation at the onset of contractions in rat muscle of contrasting fibre types (Behnke *et al.*, 2003; McDonough *et al.*, 2005). However, prior to this research, the profile for healthy whole muscle (i.e., muscle comprising the three principal fibre types) was determined and it was shown that P_{mvO_2} does not change during the first ~10-20 seconds following the onset of contractile activity (Behnke *et al.*, 2002a). This implies an initial O_2 delivery-to-utilisation matching in healthy whole muscle, presumably due to hyperemia not specifically apportioned to active fibres (Poole *et al.*, 2007). Thereafter, P_{mvO_2} decreases exponentially to the requisite (steady state) level (Behnke *et al.*, 2002a), which suggests increased fractional O_2 extraction as blood flow is distributed to areas of need (Poole *et al.*, 2007). Interestingly, a similar profile has been shown for arterial-venous O_2 extraction across (Grassi *et al.*, 1996) and deoxyhaemoglobin-inferred (estimated via near-infrared spectroscopy; NIRS) O_2 extraction within (DeLorey *et al.*, 2003; Grassi *et al.*, 2003) contracting muscle of exercising humans; therefore, this can be considered the characteristic ‘whole-muscle’ response in the absence of disease (Poole *et al.*, 2007).

The biphasic profile of fractional O_2 extraction (see above) suggests that muscle O_2 delivery does not limit muscle O_2 consumption in healthy muscle. However, fibre-type-specific differences in the P_{mvO_2} profile suggest additional complexity. Behnke *et al.* (2003) were the first to investigate these differences by determining P_{mvO_2} profiles for rat soleus and peroneal muscle (predominantly type I and type II fibres, respectively) and found that soleus demonstrates a longer MRT and smaller amplitude (i.e., a blunted P_{mvO_2} response). Importantly, these two muscles possess similar oxidative capacity (and, presumably, by extension, \dot{V}_{O_2} kinetics); therefore, the rate of O_2 utilisation in the contrasting fibre types was controlled for in this investigation. Consequently, the blunted

P_{mvO_2} response that was observed meant that soleus benefited from a more precise matching of muscle O_2 delivery to muscle O_2 utilisation, which would allow for a greater capillary pressure head for blood-tissue O_2 transfer across the rest-to-exercise transition.

McDonough *et al.* (2005) extended the findings of Behnke *et al.* (2003) by including three different muscle fibre types (soleus, mixed gastrocnemius and white gastrocnemius; i.e., predominantly type I, type IIa and type IIb fibres, respectively) and different intensity levels of contraction (i.e., low and high stimulation). Results showed that for both type II muscles, P_{mvO_2} kinetics was more rapid at the onset of contractions and P_{mvO_2} was significantly lower at rest and during both stimulation protocols despite a lower \dot{V}_{O_2} . This confirmed that unlike type I fibres, these fibres must rely on rapid and large changes in fractional O_2 extraction to attain a given \dot{V}_{O_2} . Furthermore, the higher contraction intensity elicited a faster P_{mvO_2} response in all fibres, but a further lowering of P_{mvO_2} in type II fibres only. Finally, there was a transient undershoot of P_{mvO_2} below the steady state value in type II, but not type I fibres. Interestingly, this characteristic had previously been reported in muscle of mixed fibre-type only when pathological conditions that impair O_2 delivery (e.g., diabetes and heart failure) were present (Diederich *et al.*, 2002).

The precipitous fall and transient overshoot of P_{mvO_2} indicates that O_2 delivery does not match O_2 utilisation at the onset of contractions in type II fibres (McDonough *et al.*, 2005). This suggests that a commensurate fall in intracellular PO_2 will occur (Kindig *et al.*, 2002). Considering current models of metabolic control (Meyer, 1988; Meyer, 1989), this would mandate a greater change in phosphate-linked regulators of mitochondrial respiration in response to a given increase in metabolic demand (Poole *et al.*, 2007). Consequent to these changes and much like what has been found when diseases that impair the cardiovascular

response to exercise mandate a similar $PmvO_2$ response profile (Diederich *et al.*, 2002; Poole *et al.*, 2005), $\dot{V}O_2$ kinetics might be O_2 dependent in these fibres (Poole *et al.*, 2007; see Figure 2.6) and τ_p , therefore, lengthened (Behnke *et al.*, 2002).

In-vitro evidence supporting the notion that $\dot{V}O_2$ kinetics is slower in type II fibres comes from Crow and Kushmerick (1982), who demonstrated that τ for mouse extensor digitorum longus muscle (predominantly type II fibres) is significantly longer compared to τ for soleus muscle (~138 s v. ~36 s). These researchers and others have also shown that in mouse/rat muscle, type II fibres are less energetically efficient (i.e., yield less ATP per volume O_2 consumed and/or require more ATP per unit contractile tension developed) (Wendt and Gibbs, 1973; Crow and Kushmerick, 1982; Crow and Kushmerick, 1983; Reggiani *et al.*, 1997). If high-order fibres also have a poor capacity to receive/utilise O_2 and poor oxidative efficiency in human muscle *in vivo*, it is interesting to reconsider the speculation of Brittain *et al.* (2001) (see above; i.e., pg. 61).

Work-to-work exercise and fibre-type specificity

If a pool of fibres with considerable metabolic diversity (either across the type I range or including both type I and IIA constituents) was required to satisfy a full transition from 20-W cycling to 90% GET, a transition that only spanned the upper region of this range should be characterised by slower $\dot{V}O_2$ kinetics and an increased O_2 cost of work compared to the transition that spanned the lower region. This is precisely what Brittain *et al.* (2001) had shown. Furthermore, one might expect values that were intermediate to these two extremes when this diversity was homogenised by including all fibres in a single transition to the high moderate work rate. The τ and G values reported by Brittain *et al.* (2001) also support this notion. Finally, fibres that reside higher in the recruitment hierarchy have greater total

[PCr] content and slower [PCr] kinetics (Söderlund and Hultman, 1991); therefore, a slower oxidative response during a transition that exclusively involves these fibres is in agreement with the Meyer's analogue model, which suggests increased circuit capacitance and a slower adaptation of mitochondrial respiration under these circumstances (Meyer, 1988; Meyer, 1989).

A hypothetical model that illustrates the speculation forwarded by Brittain *et al.* (2001) is provided in Figure 2.8. In this schematic, muscle fibres are represented by the horizontal bars, the heights of which indicate their place along the recruitment hierarchy. In this case, the assumption is that only type I fibres are recruited; hence, they are all of the same height. However, there is variance in oxidative/non-oxidative capacity as indicated by the red (oxidative) and blue (non-oxidative) shadings. Consequently, despite the fact that the pulmonary \dot{V}_{O_2} response profile characterising a full transition from 20-W cycling to 90% GET is indistinguishable from a single exponential, it rightly represents the combined influences of diverse exponential responses (i.e., responses with different τ and G values) that are present at opposite ends of the domain (Brittain *et al.*, 2001; Whipp and Rossiter, 2005; Whipp *et al.*, 2005).

Work-to-work exercise and O₂ availability

With the dawning of the millennium came a number of new research groups attempting to elucidate the mechanistic basis of the work-to-work exercise effect. Recognising the conflicting theories advanced by Hughson and Morrissey (1982, 1983) and Brittain *et al.* (2001), MacPhee *et al.* (2005) set forth to determine why work-to-work transitions were slower by using NIRS to monitor relative changes in active muscle oxy- (HbO₂), deoxy- (HHb) and total (Hb_{tot}) haemoglobin concentration during metabolic transitions within

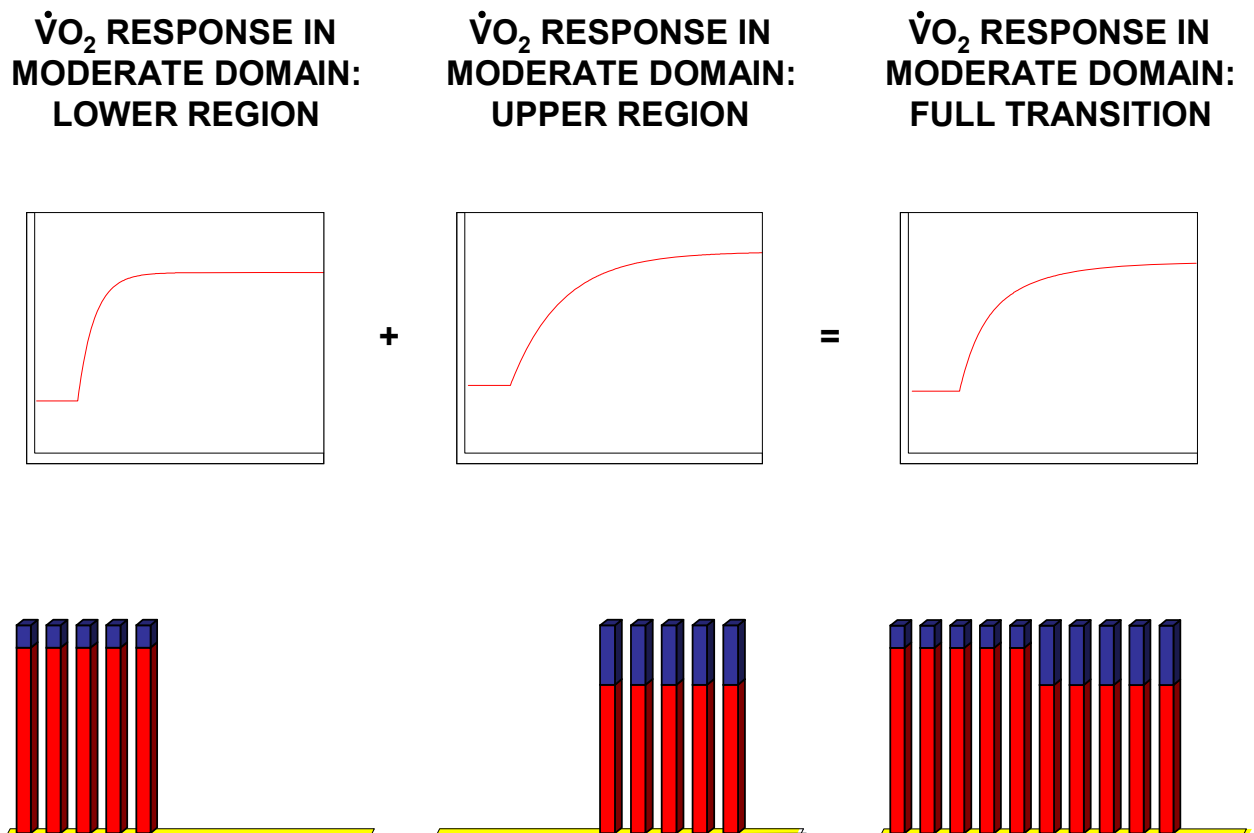

Figure 2.8: A hypothetical model depicting the effect of muscle fibre type on $\dot{V}O_2$ kinetics during exercise transitions in the lower and upper region of the moderate-intensity domain. See text for further details.

different regions of the moderate-intensity domain. NIRS provides insight into the dynamic balance between O_2 delivery and utilisation in the area of interrogation so, in conjunction with measurements of pulmonary $\dot{V}O_2$, leg blood flow (determined by pulse-waved Doppler ultrasonography) and heart rate, these researchers hoped to resolve whether O_2 availability was, in fact, constraining $\dot{V}O_2$ kinetics during work-to-work transitions. MacPhee *et al.* (2005) had subjects transition from 3-W work to 90% GET during two-legged knee-extension exercise in either one full or two half steps and, consistent with prior

findings, observed slower \dot{V}_{O_2} kinetics in the upper compared to both lower and full moderate regions. Furthermore, in support of Brittain *et al.* (2001), they found that G was greater in the upper region compared to both other transitions ($\sim 18.1 \text{ ml}\cdot\text{min}^{-1}\cdot\text{W}^{-1}$ v. 13.5 and 14.9 in lower region and full transition, respectively). Novel findings from MacPhee *et al.* (2005) were τ values for the responses of HR, leg blood flow and vascular conductance that followed a similar pattern, which supported the hypothesis forwarded by Hughson and Morrissey (1982, 1983) and also use of HR kinetics as a non-invasive assessment of the peripheral blood flow adaptation to exercise. (Note: Subsequent observation that kinetics of capillary blood flow is significantly slower than that of femoral artery blood flow during moderate knee-extension exercise by Harper *et al.* (2006) is not consistent with HR kinetics as a proxy for blood flow kinetics at the actual capillary-myocyte interface.) Furthermore, MacPhee *et al.* (2005) observed [HHb] kinetics in the upper region that was characterised by a longer τ and MRT, but shorter response time delay. A reduced [HHb] time delay is consistent with a slower adaptation of O_2 delivery to the working musculature, but a lengthened τ and MRT are not. These results and intra-transition comparisons across parameters are illustrated in Figure 2.9. Finally, MacPhee *et al.* (2005) found an increased $\Delta[\text{HHb}]/\Delta\dot{V}_{O_2}$ during the upper-region transition. Normalising the [HHb] amplitude in this manner provides an index by which the need to extract O_2 to support a given \dot{V}_{O_2} can be assessed. A greater need for O_2 extraction is consistent with an O_2 shortfall.

The findings of MacPhee *et al.* (2005) provided strong support for the notion that the work-to-work effect in the upper moderate region is mediated by a circulatory-related restriction of O_2 availability. However, additional empirical evidence to support this contention is lacking. For example, it has been demonstrated that in isolated *in situ* canine gastrocnemius preparations, pump perfusion and adenosine-induced vasodilation that

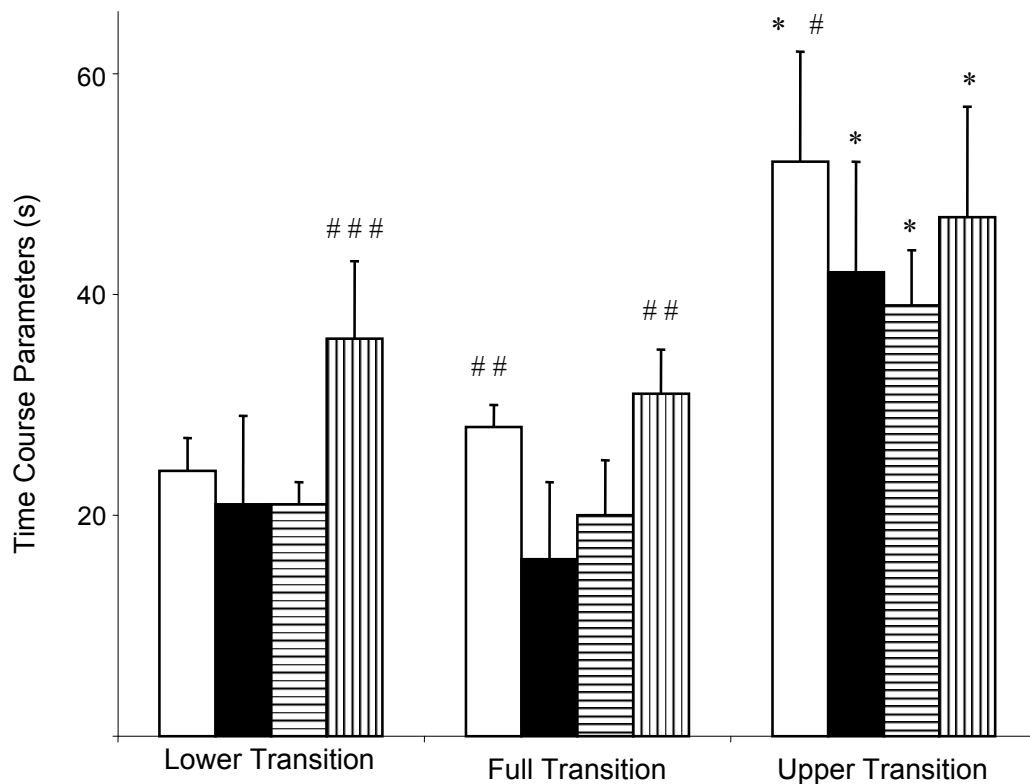

Figure 2.9: Time constant values for $\dot{V}O_2$ (open bars), HR (closed bars) and leg blood flow (horizontally striped bars), and MRT for HHb (vertically striped bars) during full moderate transitions and work-to-work transitions in the upper and lower moderate regions. For within-parameter comparisons across transitions: *Significant difference compared to the lower and full transitions. For within-transition comparisons across parameters: #Significant difference compared to leg blood flow; ##Significant difference compared to HR and leg blood flow; ###Significant difference compared to $\dot{V}O_2$, HR and leg blood flow. In all cases where differences were found, $P < 0.05$. Adapted from MacPhee *et al.* (2005).

establish muscle blood flow at the requisite steady state level prior to contractions at 60% $\dot{V}O_{2max}$ (i.e., moderate-intensity work) do not alter $\dot{V}O_2$ kinetics (Grassi *et al.*, 1998). Furthermore, as previously mentioned, $\dot{V}O_2$ kinetics during moderate-intensity cycle exercise is not affected by high-intensity priming (Gerbino *et al.*, 1996; Burnley *et al.*, 2000). The reason for the contrasting findings of MacPhee *et al.* (2005) is unclear, but

might be related to the mode of exercise that was studied. During knee-extension exercise, the active musculature was positioned differently with respect to the heart (although not at or above heart level), contractions were performed at a relatively slow rate (30 per minute) and work was isolated predominantly to one muscle group. Furthermore, intramuscular forces are likely higher and fibre recruitment patterns quite different for knee-extension exercise compared to conventional cycling. Any or all of these factors might account for an effect on circulation that would not be present during conventional cycle ergometry.

Supra-GET work-to-work exercise

Wilkerson and Jones were the next to investigate the work-to-work effect by using similar methodology for transitions that spanned multiple domains. For example, in their initial study, subjects performed cycle transitions to severe-intensity exercise ($\sim 100\% \dot{V}_{O_{2peak}}$; i.e., a workload that was sustainable for, on average, 170 s) in either one full or two partial steps from 20-W baseline cycling (Wilkerson and Jones, 2006). The partial transitions included both 20-W-to-moderate/moderate-to-severe and 20-W-to-heavy/heavy-to-severe protocols. Moderate and heavy bouts were performed at $\sim 80\%$ GET and $40\%\Delta$, respectively.

In addition to expanding intensity range, which addressed one of Morton's (1987) concerns, Wilkerson and Jones (2006) also assessed HR kinetics (as a proxy for leg blood flow kinetics, as per MacPhee *et al.* (2005)) and surface iEMG in this study. Based on the hypothesis that \dot{V}_{O_2} kinetics would be progressively slowed with each increase in baseline work rate, their objective was to test the O_2 -availability and fibre recruitment theories that had been forwarded to explain similar moderate domain nonlinearity. Furthermore, they hoped to elucidate a potential mechanistic basis for the nonlinear characteristics of full severe transitions (a longer phase II τ and decreased phase II G compared to full moderate

transitions) that had been previously reported (e.g., Poole and Jones, 2005; Wilkerson *et al.*, 2004c).

Interestingly, Wilkerson and Jones (2006) found a complete dissociation between \dot{V}_{O_2} and HR kinetics, as the phase II \dot{V}_{O_2} τ progressively lengthened (from ~ 37 to ~ 59 to ~ 93 s; $P < 0.05$ for the difference between the first and third value) as baseline work rate was increased with no corresponding change in the HR adaptive response (phase II HR τ of ~ 41 , 36 and 45 s for transitions from 20 W-, moderate- and heavy-cycling, respectively). However, there was electromyographic evidence to suggest differences between the three conditions. Specifically, despite the fact that iEMG increased during the first 30 seconds of severe exercise and then levelled off in all cases, the increase occurred in relation to an elevated baseline iEMG during the transitions from moderate and heavy cycling. Mean power frequency (MPF) followed a similar pattern, except it did not increase during the transition from heavy work. The authors' explanation was that during all transitions at the severe intensity regardless of preceding baseline, most available muscle mass was recruited (i.e., a relatively complete drive through the recruitment hierarchy was needed) to satisfy the increased requirement for contractile tension development. This meant that when the transition was made from a moderate baseline already characterised by an elevated iEMG and mean power frequency, only a higher-order portion of this pool would be available for activation. Furthermore, they suggest that the heavy baseline might have already incorporated this segment by the time the transition was made such that mean power frequency could not increase further. Consequently, the increased iEMG under these circumstances could only be accomplished by increased rate coding in already recruited motor units (Wilkerson and Jones, 2006).

In addition to an invariant HR τ across conditions (not surprising given that the cardioacceleratory stimulus that facilitated all severe transitions was predominantly sympathetically driven regardless of baseline), Wilkerson and Jones (2006) found that HR kinetics was actually *faster* than \dot{V}_{O_2} kinetics during both the moderate-to-severe and heavy-to-severe adaptations. This had resonance with previous findings of muscle blood flow kinetics that was faster than \dot{V}_{O_2} kinetics during high-intensity knee-extension exercise (Bangsbo *et al.*, 2000) and provided evidence that slower work-to-work \dot{V}_{O_2} kinetics was not due to a HR (and, by extension, bulk O_2 delivery) limitation because as noted by Poole *et al.* (2008), it is difficult to reconcile how a faster response could rate limit a slower one (see Figure 2.4). However, iEMG data did confirm differences in muscle activation and fibre recruitment population during the work-to-work transitions as fibres that would be expected to respond slower (i.e., high-order fibres) contributed an increased proportion of the work-to-work response. These investigators also observed a trend for a progressive increase of G when severe exercise was initiated from higher work rates, which supported the findings of Brittain *et al.* (2001) for transitions in the moderate domain and is consistent with an increased proportional contribution of fibres that possess lower oxidative efficiency.

In their next work-to-work study, Wilkerson and Jones examined transitions from 20-W cycling to heavy-intensity exercise (40% Δ) that were completed in either one full or two incremental steps (Wilkerson and Jones, 2007). This protocol supplied information on full moderate (80% GET), full heavy and work-to-work heavy \dot{V}_{O_2} transients and, importantly, provided novel insight into the influence of work-to-work transitions on the \dot{V}_{O_2} slow component as their previous study involved an intensity at which the slow component is not typically discerned.

Given their prior findings and those of the groups that examined moderate exercise, Wilkerson and Jones' findings for phase II \dot{V}_{O_2} and HR kinetics in this study (see Figure 2.10) were not surprising. Once again, G (in this case, both phase II and end-exercise) was greater for the work-to-work transition and there was no correlation between the work-to-work slowing of \dot{V}_{O_2} kinetics and changes in HR kinetics (see Figure 2.10). However, a surprising finding was that the amplitude of the \dot{V}_{O_2} slow component during heavy exercise was *reduced* for the work-to-work condition ($\sim 90 \text{ ml}\cdot\text{min}^{-1}$ v. $\sim 260 \text{ ml}\cdot\text{min}^{-1}$ for the full

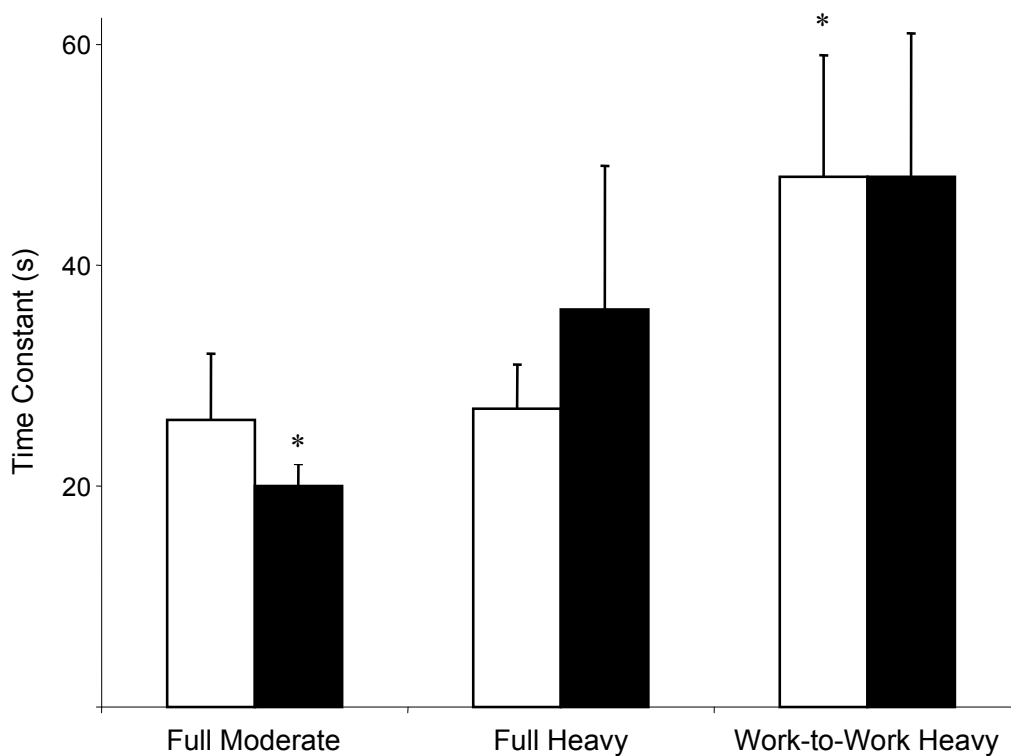

Figure 2.10: Time constant values for \dot{V}_{O_2} (open bars) and HR (closed bars) during full moderate, full heavy and work-to-work heavy transitions. For within-parameter comparisons across transitions: *Significant difference compared to both other transitions ($P < 0.05$). There were no significant within-transition differences across parameters. Adapted from Wilkerson and Jones (2007).

transition) and, in fact, totally eliminated in three of seven subjects (Wilkerson and Jones, 2007). As moderate priming exercise has been shown ineffective for facilitating the prior-exercise effect (Gerbino *et al.*, 1996; Burnley *et al.*, 2000), this result was difficult to explain.

Wilkerson and Jones (2007) also showed that the O₂ deficit (estimated as the product of MRT and total response amplitude; note, this is an ‘estimate’ because of uncertainty regarding the use of the total response amplitude as the ‘steady state’ \dot{V}_{O_2} from which back extrapolation to exercise onset takes place) per increment in work rate was greatest for the work-to-work condition, which would be expected if less efficient, slow-to-respond high-order fibres were isolated during this transition. Marshalling all of the findings from this study along with observations from prior research, Wilkerson and Jones (2007) concluded that the work-to-work effect is attributable to the isolation and unveiling of response characteristics specific to fibres that reside higher in the motor unit recruitment hierarchy.

The intracellular work-to-work exercise effect

Recently, Jones *et al.* (2008) provided further insight into work-to-work exercise by using ³¹P-MRS to assess [PCr] kinetics during full and partial transitions to heavy-intensity work. Basing their hypothesis on Meyer’s analogue model of respiratory control (Meyer, 1982; Meyer, 1983) and the previously observed inverse agreement between \dot{V}_{O_2} and [PCr] kinetics during moderate and heavy full transitions (Rossiter *et al.*, 1999; Rossiter *et al.*, 2002a), these researchers had subjects perform heavy knee-extension exercise from either a resting baseline or moderate work and confirmed that the [PCr] adaptation was markedly different depending on the transition that elicited the response. Specifically, an ~11 W increment from rest (moderate exercise) induced a [PCr] response that was both

monoexponential and rapid (τ , ~ 25 s); however, when the same change in workload was encountered during the transition from moderate-to-heavy exercise, a [PCr] slow component was present and the τ describing the fundamental response was dramatically lengthened (Jones *et al.*, 2008). The full transition to heavy exercise was also characterised by a slow component, but when the fundamental phase of the response was fit, a τ significantly different from and intermediate to the moderate and work-to-work values was revealed. Furthermore, the [PCr] G of the response was greater over both the fundamental phase and entire bout for the work-to-work compared to full heavy transition (~ 4 and $\sim 5\%$ of resting level per W, respectively, compared to ~ 2 and $\sim 3\%$) and the moderate transition engendered the lowest G. These responses showed close agreement with those previously reported for \dot{V}_{O_2} and provided further support for a functional link between high-energy phosphate splitting in the cytoplasm and oxidative phosphorylation in mitochondria (and, by extension, \dot{V}_{O_2} at the lung). Slowing of the [PCr] response is also consistent with heterogeneous fibre recruitment as the mediator of slower work-to-work \dot{V}_{O_2} kinetics because an O_2 constraint that reduced intracellular PO_2 during these transitions would be expected to *speed* [PCr] kinetics via a compensatory decrease in cellular energetic state.

Influence of muscle fibre type on $\dot{V}O_2$ kinetics

Fibre-type influence in exercising humans in vivo

In addition to inferences that can be drawn from *in-vitro* studies of animal muscle, there is a growing body of evidence to suggest that $\dot{V}O_2$ kinetics is profoundly influenced by muscle fibre type and motor unit recruitment in exercising humans. For example, it has been shown that subjects with a high proportion of type II fibres in the vastus lateralis muscle of the quadriceps are less efficient during cycle exercise than individuals with a higher proportion of type I fibres (Coyle *et al.*, 1992). Furthermore, in subjects of differing fitness levels, percent type I fibres was positively correlated with the phase II G, but negatively correlated with the relative contribution of the $\dot{V}O_2$ slow component to the end-exercise $\dot{V}O_2$ during cycle exercise at 50% Δ (Barstow *et al.*, 1996). Similar associations have been demonstrated during both heavy (50% Δ) and severe (70% Δ) cycling, and a negative correlation between type I fibres and the phase II τ for heavy exercise has also been reported (Pringle *et al.*, 2003a). Collectively, these findings cohere with *in-vitro* studies of animal muscle and suggest that high-order fibres do, in fact, generate a slower and less efficient oxidative response in exercising humans.

Intervention-induced alteration of fibre-type activation

To further elucidate the influence of muscle fibre type and motor unit recruitment on $\dot{V}O_2$ kinetics, researchers have used interventions designed to alter fibre activation to assess how the oxidative response to exercise is affected. For example, both fibre-specific glycogen depletion (Bouckaert *et al.*, 2004; Carter *et al.*, 2004; Krstrup *et al.*, 2004a; Osborne and Schneider, 2006) and neuromuscular blockade (Krstrup *et al.*, 2008) have been employed to reduce the proportional contribution of specific fibre types to the $\dot{V}O_2$ response and glycogen depletion in type II fibres was associated with alterations that would be expected

if high-order response characteristics were dampened (i.e., a faster/earlier oxidative response which is, interestingly, very similar to the prior-exercise effect) (Carter *et al.*, 2004). However, the effect that would be hypothesised if a greater high-order presence was needed to offset decreased type I glycogen content (i.e., a reduced primary G and increased slow component G) has not been universally shown (Bouckaert *et al.*, 2004; Carter *et al.*, 2004; Osborne and Schneider, 2006). A possible explanation is that the considerable capacity for free fatty acid oxidation in these fibres allows them to still function ‘normally’ in some cases even if glycogen is reduced (Bouckaert *et al.*, 2004). Nevertheless, there is evidence to suggest that ‘disabling’ low-order fibres results in a prolonged adaptation in both phases of the oxidative response (Krustrup *et al.*, 2004a; Krustrup *et al.*, 2008). Findings from these studies are summarised in Table 2.1.

Cadence has also been manipulated during cycle ergometry in an attempt to skew fibre-type activation proportionality. It is widely accepted that type II fibre recruitment is enhanced (i.e., a greater drive through the recruitment hierarchy is facilitated) when a given power output is established via greater contraction frequency (Sargeant, 1999; MacIntosh *et al.*, 2000; Sargeant, 2007). Recognising this impact, Barstow *et al.* (1996) were the first to examine the effect of extreme cadence on \dot{V}_{O_2} kinetics and found that transitions to heavy exercise were virtually unaffected by disparate pedal rates (45, 60, 75 and 90 rev·min⁻¹). In fact, other than a small reduction of primary component amplitude and G at 90 compared to the other three cadences, there were no significant differences in any kinetics parameters. However, Pringle *et al.* (2003b) would question whether the range of cadences examined by Barstow *et al.* (1996) was broad enough to reveal differences that might be present. Expanding the range from 35 to 115 rev·min⁻¹, these researchers showed that \dot{V}_{O_2} kinetics was markedly different at both extremely fast and slow pedal rates (Pringle *et al.*, 2003b)

Table 2.1: Summary of findings from investigations that explored the effect of altering motor unit activation by fibre-type specific selective glycogen depletion or neuromuscular blockade.

Investigation	Intervention	Proposed Influence	Exercise Mode/Intensity	Observed Effect on O_2 Uptake Kinetics
Carter <i>et al.</i> (2004)	FT fibre glycogen depletion	↓ FT	Heavy cycling	<ul style="list-style-type: none"> • ↑ primary amplitude/G • ↔ primary τ • ↓ SC absolute/relative amplitude • ↑ SC TD • ↓ Δblood [lactate]
Carter <i>et al.</i> (2004)	ST fibre glycogen depletion	↓ ST	Heavy cycling	<ul style="list-style-type: none"> • ↔ primary τ • ↔ primary/SC amplitude/G
Bouckaert <i>et al.</i> (2004)	ST fibre glycogen depletion	↓ ST	Heavy cycling	<ul style="list-style-type: none"> • ↔ primary τ • ↔ primary/SC amplitude/G

Table 2.1: Continued from page 78.

Investigation	Intervention	Proposed Influence	Exercise Mode/Intensity	Observed Effect on O_2 Uptake Kinetics
Krustrup <i>et al.</i> (2004)	ST fibre glycogen depletion	↓ ST	Moderate	• ↔ primary τ
			cycling	• ↑ primary amplitude
				• SC created
Osborne <i>et al.</i> (2006)	ST fibre glycogen depletion	↓ ST	Heavy	• ↑ phase I amplitude
			cycling	• primary amplitude
				• ↔ primary τ
Krustrup <i>et al.</i> (2008)	ST fibre neuromuscular blockade	↓ ST	Moderate knee-	• ↔ SC absolute/relative amplitude/TD
			extension exercise	• ↑ end-exercise amplitude
				• ↓ blood [lactate] – minutes 6 and 8
				• ↑ primary τ
				• ↓ primary TD
			• ↑ primary amplitude ($P = 0.07$ only)	
				• ↓ mechanical efficiency

and future researchers studied similar rapid cadences to further elucidate the effect (Migita *et al.*, 2006; Vercruyssen *et al.*, 2008). In support of their original experimental hypothesis, studies that examined the effect of extreme cadence on \dot{V}_{O_2} kinetics subsequent to Barstow *et al.* (1996) confirmed that the amplitude of the \dot{V}_{O_2} slow component was greater at extremely fast cadences (Pringle *et al.*, 2003b; Migita *et al.*, 2006; Vercruyssen *et al.*, 2008). Furthermore, Pringle *et al.* (2003b) observed a reduced primary G during heavy exercise (cadence-specific 50% Δ) at both 75 and 115 rev \cdot min $^{-1}$ (\sim 9.5 and \sim 8.9 ml \cdot min $^{-1}\cdot$ W, respectively) compared to 35 rev \cdot min $^{-1}$ (\sim 10.6 ml \cdot min $^{-1}\cdot$ W) and moderate cycling (80% GET) at 75 rev \cdot min $^{-1}$ (\sim 10.6 ml \cdot min $^{-1}\cdot$ W). In contrast, Migita *et al.* (2006) and Vercruyssen *et al.* (2008) each found that the primary amplitude during heavy cycling was greater at faster cadences (110 rev \cdot min $^{-1}$ compared to 60 and 50 rev \cdot min $^{-1}$, respectively); however, in these studies, subjects initiated their transitions from rest. For any given power output, gross efficiency is lower at high pedal rates because of the additional energetic cost of turning the legs at the faster movement frequency (Gaesser and Brooks, 1975) and this extra oxidative expense can amount to 500 ml \cdot min $^{-1}$ or more at extremely fast cadences (Jones and Poole, 2005). Consequently, initiating exercise from an ‘unloaded’ baseline (e.g., as in Pringle *et al.* (2003b)) that already includes this substantial expense is far different than initiating it from one that does not. Findings from these studies are summarised in Table 2.2.

Fibre-type activation – exercise intensity dependence

With respect to specific fibre-type involvement, muscle biopsies extracted during both moderate- and high-intensity cycling have shown glycogen depletion profiles that suggest the exclusive involvement of type I fibres in the former and activation of both principal fibre types from close to exercise onset during the latter (Krustrup *et al.*, 2004b). In concert

Table 2.2: Summary of findings from investigations that explored the effect of altering motor unit activation by manipulating pedal cadence.

Investigation	Intervention	Proposed Influence	Exercise Mode/Intensity	Observed Effect on O_2 Uptake Kinetics
Pringle <i>et al.</i> (2003b)	Extremely slow pedal rate (35 rev·min ⁻¹ v. 75 and 115)	↑ ST	Heavy cycling	<ul style="list-style-type: none"> • ↑ primary G • ↓ Δblood [lactate]
Pringle <i>et al.</i> (2003b)	Extremely fast pedal rate (115 rev·min ⁻¹ v. 35)	↑ FT	Heavy cycling	<ul style="list-style-type: none"> • ↓ primary G • ↑ SC absolute/relative amplitude • ↑ end-exercise amplitude • ↑ Δblood [lactate]

Table 2.2: Continued from page 81.

Investigation	Intervention	Proposed Influence	Exercise Mode/Intensity	Observed Effect on O_2 Uptake Kinetics
Migita <i>et al.</i> (2006)	Extremely fast pedal rate (110 rev·min ⁻¹ v. 60)	↑ FT	Heavy cycling	<ul style="list-style-type: none"> • ↑ primary amplitude • ↓ primary τ • ↑ SC absolute/relative amplitude • ↓ SC TD • ↑ end-exercise amplitude • ↑ Δblood [lactate]
Vercruyssen <i>et al.</i> (2008)	Extremely fast pedal rate (110 rev·min ⁻¹ v. 50)	↑ FT	Heavy cycling	<ul style="list-style-type: none"> • ↑ primary amplitude • ↑ SC absolute/relative amplitude • ↑ end-exercise amplitude

with the aforementioned findings that suggest considerably different oxidative response characteristics in high- compared to low-order fibres, this observation supports the notion that the break from oxidative system linearity for exercise above the GET is a consequence of the need to recruit high-order fibres with diverse metabolic characteristics to satisfy the increased requirement for power production under these circumstances.

Muscle fibre type, motor unit recruitment and the \dot{V}_{O_2} slow component

A plethora of theories have been advanced to explain the \dot{V}_{O_2} slow component phenomenon since it was first identified. However, subsequent investigations would reveal that many of the proposed mediators (e.g., the O_2 cost associated with circulating catecholamines, potassium, the gluconeogenic removal of elevated lactate, pulmonary work, cardiac work and muscle temperature) played little or no role. For example, even though the temporal profile of blood [lactate] elevation during exercise above the GET is well correlated with slow component progression (Roston *et al.*, 1987), direct L-(+)-lactate infusion into contracting dog gastrocnemius muscle does not elevate \dot{V}_{O_2} (Poole *et al.*, 1994). Furthermore, despite the fact that epinephrine infusion increases baseline \dot{V}_{O_2} , it does not create a further increase during exercise (Gaesser *et al.*, 1994). It is, therefore, likely that the association between these two exercise-induced perturbations (and, in all likelihood, many of the others that were advanced) and the \dot{V}_{O_2} slow component is coincidental, not causal. Moreover, after Poole *et al.* (1991) determined that the vast majority of the slow component could be ascribed to processes occurring within the exercising musculature, the list of candidate mechanisms was decreased even further. The identification of a [PCr] slow component within active muscles during heavy exercise (Rossiter *et al.*, 2001; Rossiter *et al.*, 2002a; Jones *et al.*, 2008) had similar implications. In addition, this latter

finding suggests that the slow component represents an increased high-energy phosphate cost of tension development as opposed to an increased O_2 cost of phosphorylation.

Given all of these findings and considering the potential impact that muscle fibre type and motor unit recruitment have on \dot{V}_{O_2} kinetics, it is not surprising that specific aspects of this relationship have been implicated in the aetiology of the \dot{V}_{O_2} slow component. In theory, one can envisage a number of scenarios whereby unique fibre-specific characteristics and corresponding activation patterns could underlie this phenomenon. Some (numbered arbitrarily) are outlined below:

- Theory 1: The pool of initially-recruited fibres is incapable of sustaining high-intensity work; therefore, delayed-onset recruitment of higher-order fibres is required to replace fatiguing ones as exercise proceeds (Whipp, 1994; Gaesser and Poole, 1996; Jones *et al.*, 2005). This one-for-one trade would result in a progressive increase in \dot{V}_{O_2} if the newly activated fibres were less energetically efficient.
- Theory 2: The loss of fatigue-susceptible high-order members of the initially-recruited pool mandates a compensatory increase of rate coding in previously active low-order fibres (Pringle *et al.*, 2003b; Jones *et al.*, 2005). This exchange would result in a progressive increase in \dot{V}_{O_2} if type I fibres are less efficient under these particular circumstances (e.g., when power requirements are high).
- Theory 3: The pool of initially-recruited fibres is incapable of sustaining high-intensity work; therefore, delayed-onset fibre activation (either increased recruitment of new fibres or increased rate coding in previously active ones) of either low- or high-order fibres is required to replace fatiguing fibres as exercise proceeds. Even if this adjusted ‘strategy’ is no less energetically efficient, this

exchange could result in a progressive increase in \dot{V}_{O_2} if the fibres that were no longer contributing to power production were still consuming O_2 to restore ionic homeostasis (i.e., recovery processes) (Jones *et al.*, 2005; Poole and Jones, 2005).

- Theory 4: The pool of initially-recruited fibres is capable of sustaining the work rate; however, some of the fibres can only do so in conjunction with a loss of contractile efficiency (e.g., more ATP hydrolysis per contractile tension developed) (Woledge, 1998; Zoladz *et al.*, 2008). Consequently, \dot{V}_{O_2} will rise with time.
- Theory 5: A sufficiently advanced drive through the motor unit recruitment hierarchy occurs at exercise onset such that fibres comprising an extremely wide range of τ and G values are activated. The fastest responding fibres (e.g., the low-order ones that would be exclusively featured during a transition within the lower region of the moderate domain) combine with some of higher order with slightly longer τ values to ‘redefine’ a slower phase II ‘exponential’ response that actually melds numerous exponentials (Whipp and Rossiter, 2005; Whipp *et al.*, 2005). The response profiles of initially recruited high-order fibres with even slower \dot{V}_{O_2} kinetics protract past this heterogeneous phase II, thereby establishing an entirely ‘different’ response phase (Brittain *et al.*, 2001; Wilkerson and Jones, 2006). This would also explain the *reduced* phase II G during exercise where *less* efficient fibres should be featured: In essence, part of the slow component G would have to be added to the phase II G in order to reveal the true phase II oxidative cost of all of the fibres required under these circumstances.

While any of these theories individually or collectively, or numerous others could explain an increased oxidative cost of constant-load work that is attributable to specific fibre-type response characteristics, this list does reveal an important point. Conceptually, theories

that attribute the $\dot{V}O_2$ slow component to fibre-type/recruitment-related factors can be differentiated based on whether they do (e.g., theories 1, 2 and 3) or do not (e.g., theories 4 and 5) depend upon delayed-onset fibre activation. Investigations that have addressed this question can, therefore, provide considerable insight.

Delayed-onset motor unit activation and the $\dot{V}O_2$ slow component

Evidence that supports progressive activation of fibres during high-intensity exercise comes from the insightful work of Krstrup *et al.* (2004b) that was mentioned previously. In addition to glycogen content, these researchers also measured [PCr] from the biopsies they extracted and found profiles that indicated the additional activation of both principal fibre types with a proportional shift toward type II fibres from minute three to six in association with the $\dot{V}O_2$ slow component during cycling at 80% $\dot{V}O_{2max}$ (Krstrup *et al.*, 2004b). Furthermore, it has been reported that plasma ammonia was unchanged during the first three minutes of cycling at 50% Δ , but increased thereafter (Sabapathy *et al.*, 2005). Plasma ammonia is elevated consequent to myokinase-related adenosine monohydrate deamination in active muscle which should, theoretically, be greater when type II fibres are involved. Sabapathy *et al.* (2005) also found that this rise from minute three was correlated with the amplitude of the $\dot{V}O_2$ slow component, which emerged at ~132 s.

Contrary to these findings, a recent study by Zoladz *et al.* (2008) indicated that slow component behaviour can occur without progressive fibre recruitment. These researchers electrically induced submaximal contractions (~60-70% $\dot{V}O_{2peak}$) in an isolated *in-situ* dog gastrocnemius preparation and found a fatigue-related decline in force production during the four-minute contraction period that was associated with a constant (or, in one case, increasing) $\dot{V}O_2$ (Zoladz *et al.*, 2008). Therefore, when $\dot{V}O_2$ was normalised per unit force

developed, a reduction of oxidative efficiency was present in all cases. This slow component-like phenomenon accounted for ~20-25% of the total oxidative response and, importantly, occurred even though the model mandates maximal activation of all involved fibres from contraction onset.

With respect to delayed-onset fibre activation and the $\dot{V}O_2$ slow component, the findings of Zoladz *et al.* (2008) contradict those of Krstrup *et al.* (2004b) and Sabapathy *et al.* (2005). Unfortunately, findings from investigations that involved assessment of fibre activation by electromyography (integrated electromyogram or root mean square and/or mean or median power frequency) and/or magnetic resonance imaging (T2; i.e., the relaxation time of muscle protons, which is believed to indicate muscle use) during constant-load exercise are equally inconclusive. A summary of these is provided in Tables 2.3 and 2.4.

Clearly, it is impossible to draw a unanimous conclusion from the 22 investigations summarised in Tables 2.3 and 2.4 with regard to either a general tendency for delayed-onset fibre activation as high-intensity exercise proceeds or, specifically, an increased contribution from high-order fibres in association with the $\dot{V}O_2$ slow component. For example, of the 16 that included measurement of mean/median power frequency (MPF) within a paradigm where a $\dot{V}O_2$ slow component was observed or inferred, five reported a progressive increase during high-intensity exercise (in two cases correlated with slow component amplitude, in two cases uncorrelated; no correlation results were provided for the other study) and 11 found no change. Furthermore, one observed an increase during moderate exercise even though no slow component was present. It has been suggested that

Table 2.3: Summary of findings from investigations that involved assessment of fibre activation by electromyography (integrated electromyogram or root mean square and/or mean or median power frequency) and O_2 uptake during constant-load exercise.

Investigation	Muscle Group(s)	Exercise Mode & Intensity	Observed Change(s) With Time
Shinohara & Moritani (1996)	Quadriceps	Cycling 10% below GET	<ul style="list-style-type: none"> No Δ in iEMG or $\dot{V}O_2$ with time
		Cycling 30% above GET	<ul style="list-style-type: none"> iEMG \uparrow: post-min-4 iEMG \uparrow correlated w/ $\dot{V}O_2$ \uparrow Constant $\dot{V}O_2$/iEMG throughout
Lucia <i>et al.</i> (2000)	Vastus Lateralis	Cycling 50% between GET & RCT (~80% $\dot{V}O_{2max}$) professional cyclists	<ul style="list-style-type: none"> $\dot{V}O_2$ \uparrow: min 3\rightarrow20 No associated MPF or RMS \uparrow
Saunders <i>et al.</i> (2000)	Vastus Lateralis Rectus Femoris	Cycling 15% below GET	<ul style="list-style-type: none"> No MPF, RMS or $\dot{V}O_2$ \uparrow: min 3\rightarrow15
		Cycling 60% Δ	<ul style="list-style-type: none"> $\dot{V}O_2$ slow component present MPF and RMS \uparrow: min 3\rightarrow15 (VL only)
Perrey <i>et al.</i> (2001)	Rectus Femoris Vastus Medialis Biceps Femoris Gastrocnemius	Cycling 90% GET	<ul style="list-style-type: none"> No ΔiEMG with time

Table 2.3: Continued from page 88.

Investigation	Muscle Group(s)	Exercise Mode & Intensity	Observed Change(s) With Time
Perrey <i>et al.</i> (2001) (cont)	Rectus Femoris Vastus Medialis Biceps Femoris Gastrocnemius	Cycling ('concentric') 70% Δ Cycling ('eccentric') same absolute WR as concentric	<ul style="list-style-type: none"> $\dot{V}O_2$ SC during concentric only Concentric: iEMG min 5 & 6 > iEMG min 1, 2, 3 (VM and RF only) Eccentric: no ΔiEMG with time MPPF: no Δ with time for any muscle/condition
Borrani <i>et al.</i> (2001)	Bilateral: Vastus Lateralis Gastrocnemius Lat Soleus	Treadmill Running to exhaustion 95% $\dot{V}O_{2max}$	<ul style="list-style-type: none"> MPPF \downarrow in primary $\dot{V}O_2$ phase: VL (r), Gastroc (l/r), Sol (l) MPPF \uparrow w/ $\dot{V}O_2$ slow component: VL (l/r), Gastroc (l/r) MPPF \uparrow & $\dot{V}O_2$ SC: concurrent onset MPPF \uparrow & $\dot{V}O_2$ SC: amplitudes correlated for Gastroc (l) & Sol (r)
Scheuermann <i>et al.</i> (2001)	Vastus Lateralis	Cycling 90% GET Cycling (unprimed & primed) 50% Δ	<ul style="list-style-type: none"> iEMG & MPPF: no Δ with time iEMG & MPPF: no Δ with time (both bouts) $\dot{V}O_2$ SC: present (both bouts) Priming \rightarrow \sim45% \downarrow $\dot{V}O_2$ SC

Table 2.3: Continued from page 89.

Investigation	Muscle Group(s)	Exercise Mode & Intensity	Observed Change(s) With Time
Burnley <i>et al.</i> (2002a)	Gluteus Maximus Vastus Lateralis Vastus Medialis	Cycling (unprimed & primed) 70% Δ	<ul style="list-style-type: none"> iEMG (avg/individual muscle) \uparrow throughout (unprimed) priming \rightarrow \uparrow primary $\dot{V}O_2$ amp/\downarrow SC iEMG (avg/individual muscle) $> v$. Unprimed from min 0 to 2 after priming; no \uparrow thereafter Primary phase: similar $\dot{V}O_2$/iEMG during unprimed & primed Slow phase: no correlation for SC $\downarrow v$. ΔiEMG MPF: similar for unprimed & primed
Pringle & Jones (2002)	Vastus Lateralis	Cycling 4 x 30-min at heavy (range from 100% GET to 50% Δ) 4 x to-exhaustion at severe (range from 50% Δ to 115% $\dot{V}O_{2max}$)	<ul style="list-style-type: none"> Large interindividual variability precluded attainment of statistical significance for ΔiEMG with time at any WR
Avogadro <i>et al.</i> (2003)	Biceps Femoris Gastrocnemius Med Tibialis Anterior Vastus Lateralis	Treadmill Running (both preactivation & reflex phase) 90% $\dot{V}O_{2max}$ to exhaustion	<ul style="list-style-type: none"> $\dot{V}O_2$ SC present \uparrow iEMG min 3\rightarrow10: only in VL during reflex phase MPF: no Δ in any muscle/either phase

Table 2.3: Continued from page 90.

Investigation	Muscle Group(s)	Exercise Mode & Intensity	Observed Change(s) With Time
Tordi <i>et al.</i> (2003)	Vastus Lateralis Vastus Medialis Rectus Femoris Gastrocnemius Med	Cycling 2 x bouts at 85% $\dot{V}O_{2peak}$ separated by 2 x 10-min rest + 3 x 30-sec all- out sprints	<ul style="list-style-type: none"> • $\dot{V}O_2$ SC present (both bouts) • iEMG & MPF: no Δ with time (either bout) • Priming \rightarrow \downarrow τ_p, but no Δ amplitudes • iEMG & MPF: similar for primed v. unprimed
Cleziou <i>et al.</i> (2004)	Bilateral: Vastus Lateralis Vastus Medialis	Cycling 80% GET	<ul style="list-style-type: none"> • MPF: no Δ 1st minute (all muscles) • MPF: \uparrow post-min-2/-3: all muscles except VM (τ)
Sabapathy <i>et al.</i> (2005)	Vastus Lateralis	Cycling 50% Δ	<ul style="list-style-type: none"> • $\dot{V}O_2$ SC present • Primary phase: MPF \downarrow with time (3 of 4 muscles) • Slow phase: MPF tended to \uparrow in some muscles • No correlation for delayed-onset MPF \uparrow v. $\dot{V}O_2$ SC amplitude
		Cycling 50% Δ	<ul style="list-style-type: none"> • $\dot{V}O_2$ SC present • iEMG: \uparrow throughout • iEMG/$\dot{V}O_2$: relatively constant post-min-3 (similar to baseline value) • MPF: \downarrow at onset, nadir at min 2, \uparrow from min 3 \rightarrow end

Table 2.3: Continued from page 91.

Investigation	Muscle Group(s)	Exercise Mode & Intensity	Observed Change(s) With Time
Garland <i>et al.</i> (2006)	Rectus Femoris	Knee-extension Exercise 30% GET	<ul style="list-style-type: none"> iEMG & MPF: no Δ with time after square-wave \uparrow at exercise onset $\dot{V}O_2$ SC present iEMG & MPF: no Δ with time after square-wave \uparrow at exercise onset & no discernible Δ after SC emergence
Migita <i>et al.</i> (2006)	Vastus Lateralis	Cycling at 60 & 110 rev·min ⁻¹ 60: 130% GET 110: same absolute WR	<ul style="list-style-type: none"> $\dot{V}O_2$ SC: present at both cadences iEMG & MPF: no Δ with time at either cadence
Osborne & Schneider (2006)	Vastus Lateralis Vastus Medialis Biceps Femoris	Cycling both w/ & w/out \downarrow muscle glycogen in type I fibres 50% Δ	<ul style="list-style-type: none"> $\dot{V}O_2$ SC: present for both states iEMG: no Δ with time for either state MPF: \uparrow with time (only VM & VL, both states and glycogen-depleted state, respectively) MPF \uparrow correlated w/ SC magnitude (VL glycogen replete only)
Wilkerson & Jones (2006)	Vastus Lateralis	Cycling 20 W \rightarrow 80% GET 20 W \rightarrow 40% Δ 20W, 80% GET, 40% Δ \rightarrow 100% $\dot{V}O_{2peak}$	<ul style="list-style-type: none"> $\dot{V}O_2$ SC only present in 3 of 21 severe transitions performed (i.e., 7 subjects x 3 severe transitions from different baselines) iEMG & MPF: \uparrow at exercise onset; no Δ with time for any transition

Table 2.3: Continued from page 92.

Investigation	Muscle Group(s)	Exercise Mode & Intensity	Observed Change(s) With Time
Cannon <i>et al.</i> (2007)	Vastus Lateralis Gastrocnemius Lat	Cycling 50% Δ	<ul style="list-style-type: none"> $\dot{V}O_2$ SC present MPF & RMS: no Δ with time
Vercruyssen <i>et al.</i> (2008)	Vastus Lateralis Vastus Medialis	Cycling at 50 & 110 rev·min ⁻¹ 50% Δ derived from 80 rev·min ⁻¹ test	<ul style="list-style-type: none"> $\dot{V}O_2$ SC present at both cadences (greater magnitude at 110) iEMG flow: progressive \uparrow throughout at 110, but not at 50 slow phase (post-135 s): total iEMG flow > for 110 v. 50 SC amplitude/iEMG flow: similar at both cadences MPF: no Δ with time either cadence
Layek <i>et al.</i> (2009)	Vastus Lateralis	Knee-extension Exercise (unprimed & primed) 35-40% MVC	<ul style="list-style-type: none"> iEMG/WR unprimed: no Δ min 0\rightarrow2; \uparrow thereafter; > at min 6 v. onset iEMG/WR primed: > v. unprimed for early stages; no Δ throughout MPF: fairly stable with time for both
Bailey <i>et al.</i> (2010)	Vastus Lateralis	Cycling (unprimed & primed) 80% Δ Primed by: 40% Δ + 3, 9 or 20 min recovery 70% Δ + 3, 9 or 20 min recovery	<ul style="list-style-type: none"> $\dot{V}O_2$ SC present in all conditions Priming \rightarrow \downarrow SC in 4 of 6 conditions iEMG: > at end v. min 2 for control and primed bouts w/ no SC \downarrow SC \downarrow correlated w/ iEMG \downarrow for one primed condition

Table 2.4: Summary of findings from investigations that involved assessment of fibre activation by magnetic resonance imaging (T2; i.e., the relaxation time of muscle protons).

Investigation	Muscle Group(s)	Exercise Mode & Intensity	Observed Change(s) With Time
Saunders <i>et al.</i> (2000)	Total Lower Extremity Vastus Lateralis Rectus Femoris	Cycling 15% below GET	<ul style="list-style-type: none"> No T2 or $\dot{V}O_2$ ↑: min 3 → 15
		Cycling 60%Δ	<ul style="list-style-type: none"> $\dot{V}O_2$ slow component present T2 ↑: min 3 → 15 (all muscles) T2 ↑ correlated w/ $\dot{V}O_2$ ↑
Saunders <i>et al.</i> (2003)	Total Lower Extremity Vastus Lateralis Rectus Femoris	Cycling pre- and post-training (4 weeks cycle endurance) 15% below GET	<ul style="list-style-type: none"> End-exercise $\dot{V}O_2$: no Δ pre v. post training End-exercise T2: no Δ pre v. post training Control group: no Δ $\dot{V}O_2$ or T2
		Cycling pre- and post-training (4 weeks cycle endurance) 60%Δ	<ul style="list-style-type: none"> End-exercise $\dot{V}O_2$: small ↓ pre v. post training (attributed to ↓ SC because unchanged at min 3) End-exercise T2: ↓ for VL only Control group: no Δ $\dot{V}O_2$ or T2

Table 2.4: Continued from page 94.

Investigation	Muscle Group(s)	Exercise Mode & Intensity	Observed Change(s) With Time
Endo <i>et al.</i> (2007)	Rectus Femoris Vastus Lateralis Vastus Medialis Vastus Intermedius Sartorius Gracilis Adductor Magnus Adductor Longus Semitendinosus Gluteus Maximus	Cycling 80% GET Cycling 70% Δ GET/CP Cycling >CP (predicted duration ~12 min)	<ul style="list-style-type: none"> • No $\dot{V}O_2$ SC present • T2: \uparrow from min 3\rightarrow6 in VM only • $\dot{V}O_2$ SC present • T2: \uparrow with time in VL, VM, VI • T2: values more diverse post-min-3 • Progressive broadening of T2 values correlated w/ SC • $\dot{V}O_2$ SC of greater magnitude present • T2: \uparrow with time in VL, VM, VI, Grac, Add Mag + tendency for \uparrow with time in 4 other muscles • Significant correlation between magnitude of T2 Δ and SC for VL, VI, Add Mag, area weighted sum of all muscles • T2: values more diverse even earlier • Progressive broadening of T2 values correlated w/ SC

power spectral analysis is useful for inferring specific fibre-type recruitment because power frequency depends upon the conduction velocity of action potentials as they traverse interrogated sarcolemma (Kupa *et al.*, 1995). Fast-twitch motor units contain larger fibres that propagate faster; therefore, the degree of their involvement should be reflected in higher power frequency content. This is supported by muscle biopsies that revealed the proportional involvement of type II muscle fibres was greater in association with an increase in MPF (Gerdle *et al.*, 1991). However, there are other factors that can influence action potential propagation and, therefore, MPF during exercise; for example, conduction velocity can increase with temperature (Petrofsky *et al.*, 1980) and decrease with fatigue/metabolite accumulation (Bouissou *et al.*, 1989; Ament *et al.*, 1993) and in conjunction with the attainment of greater synchronicity in previously-active slow-twitch motor units (Kranz *et al.*, 1983). Furthermore, MPF can be influenced by changes in firing frequency in already-active fibres (Jones *et al.*, 2005). Therefore, consequent to these limitations, the fact that only a small number of studies revealed power spectral data to support the role of delayed-onset activation of high-order fibres in the aetiology of the $\dot{V}O_2$ slow component must be interpreted with caution (Jones *et al.*, 2005).

Compared to power spectral analysis of the electromyogram, a more compelling yet far from unequivocal determination can be drawn from the investigations that assessed global EMG characteristics to provide a gross estimate of muscle activation (recruitment or rate coding) during exercise. Of the 17 that included measurement of iEMG or root mean square within a paradigm where a $\dot{V}O_2$ slow component was observed or inferred, nine showed that muscle activation increases as high-intensity exercise proceeds (in one case correlated with slow component amplitude, in two cases, associated by maintenance of

ratio constancy, in one case uncorrelated; no correlation stated in the other five studies). Furthermore, in five of these 17 studies, priming was included in the methodology and results from three of the four that found a priming-induced slow component reduction also show an altered iEMG. In addition, no increase of iEMG was observed for moderate exercise in the five investigations that included this assessment and it is also interesting to note that the studies that revealed no progressive increase during ‘high-intensity’ exercise tended to investigate supra-GET exercise of *lower* intensity. For example, of the eight studies showing that the null hypothesis for increased muscle activation could not be rejected, two exclusively considered exercise that would be categorised as heavy (confirmed by CP testing in one case) and three others involved exercise at 50% Δ (on average, the delineation point between the heavy and severe domains; Poole *et al.*, 1988). Accordingly, Garland *et al.* (2006) warn that it is essential to precisely control for exercise intensity when considering the effect of fibre-type recruitment on the $\dot{V}O_2$ slow component because the effects might be different depending on the eventual consequence of its progression (whether the maximum $\dot{V}O_2$ will be attained; i.e., if exercise is above CP). This has resonance with a hypothesis forwarded by Wilkerson and Jones (2006), who suggest two distinctly different mechanistic bases to explain slow component behaviour depending on whether or not $\dot{V}O_2$ will eventually stabilise (i.e., whether supra-GET exercise is heavy or severe). In their schema, heavy exercise can be sustained without delayed-onset fibre activation; however, compared to moderate exercise, greater heterogeneity within the initially recruited pool creates a slow component (see Theory 5 above). Conversely, above CP, a similar response is no longer sufficient and some form of additional activation must occur (e.g., Theories 1, 2 and/or 3) to maintain power output. This causes $\dot{V}O_2$ to rise inexorably until the maximal attainable value is achieved and exercise cessation is imminent. This hypothetical model is depicted in Figure 2.11.

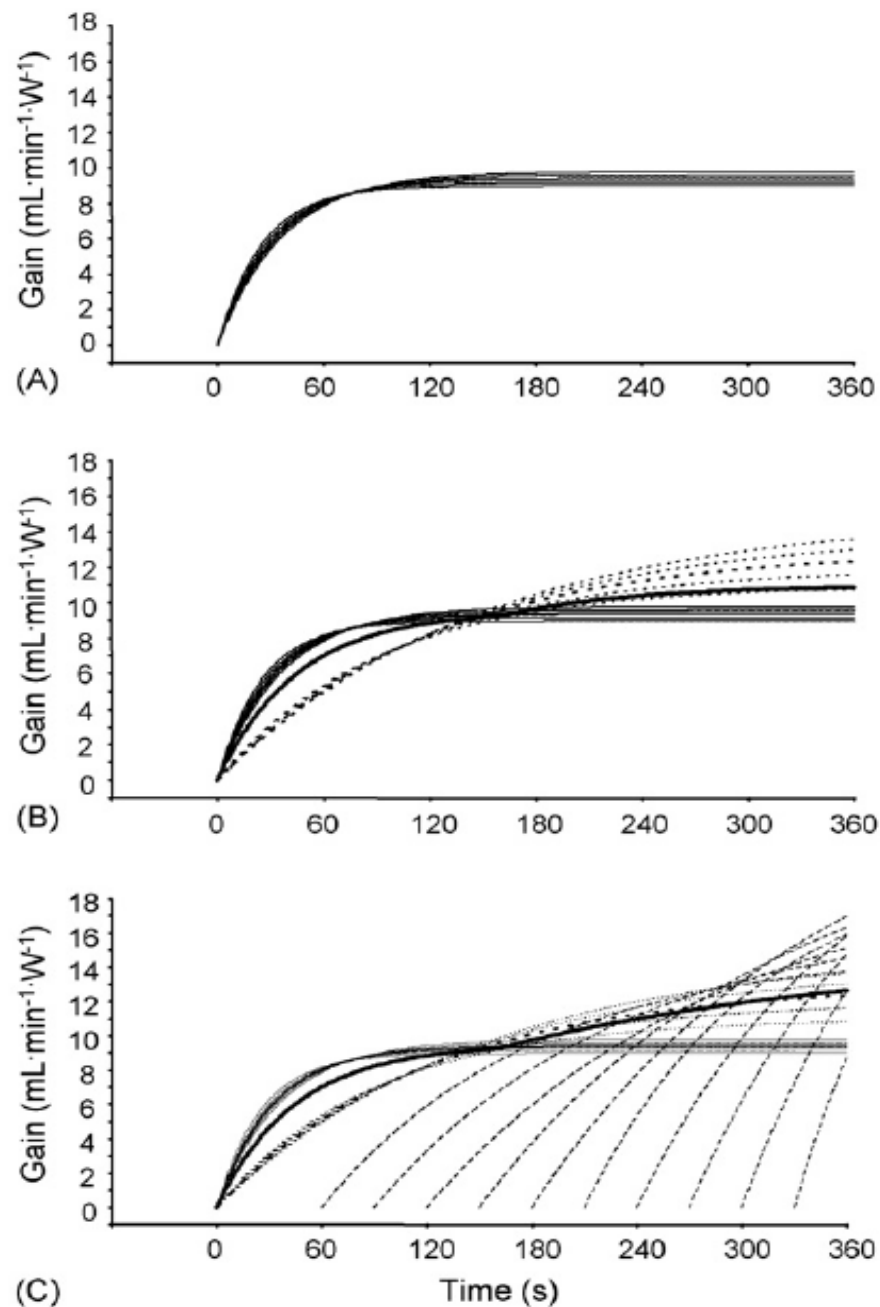

Figure 2.11: A hypothetical model depicting the possible influence of the recruitment of muscle fibres with different metabolic response profiles on the $\dot{V}O_2$ response to moderate (panel A), heavy (Panel B) and severe (Panel C) exercise. The solid lines represent the $\dot{V}O_2$ responses of muscle fibres with relatively fast kinetics and high efficiency and the dashed lines represent the $\dot{V}O_2$ responses of muscle fibres with relatively slow kinetics and low efficiency. The solid bold line within each panel represents the hypothetical mean $\dot{V}O_2$ response of all recruited fibres. See text for further details. Reprinted from Wilkerson and Jones (2006).

Oxidative system nonlinearity or linear diversity?

If nonlinear aspects of the $\dot{V}O_2$ response can be attributed to heterogeneity within the recruited population of muscle fibres, the issue of oxidative system linearity must be reconsidered. For example, if each fibre that contributes to tension development were to be considered a unique system unto itself, Boltzmann's principle of superposition might very well be in effect; that is, the same critical rate modulator (e.g., the creatine kinase reaction) might exert control and, as long as the requirement for power production was sufficient to invoke its activation, the fibre might respond with the same inertia (τ) and efficiency (G) regardless of the function that forced the response. Departures from linearity indicated by the pulmonary signal would, therefore, simply represent this 'diversity of linear control.' Alternatively, fibres that reside higher in the recruitment hierarchy might have a different locus of control. For example, the tipping point that has been proposed for entire organisms (see Figure 2.6) might be better applied to individual muscle fibres because under normal conditions, some high-order fibres might operate to its left (i.e., within the O_2 -dependent zone). This would explain why microvascular O_2 pressure falls farther (and below the steady state level) and more precipitously in these fibres (Behnke *et al.*, 2003; McDonough *et al.*, 2005) and confirm that the pulmonary signal provides a true representation of nonlinear behaviour because a different locus of control would be incorporated whenever these fibres were recruited. Interestingly, this could also change interpretation of the prior-exercise effect. If the slow component represents a separate response phase 'created' by the protracted $\dot{V}O_2$ responses of initially recruited fibres (i.e., Theory 5 above) and these fibres are sluggish because they are operating to the left of the tipping point (i.e., within the O_2 -dependent zone), a slow-to-primary amplitude shift and unchanged phase II τ might actually support the O_2 -delivery limitation (albeit exclusively in these fibres) that it has typically been cited to refute.

Summary

During the 200-plus years since the discovery of O₂ and its role in biological oxidation, many scientists have contributed to our understanding of oxidative system linearity and its implication with regard to metabolic control. It is now apparent that the pulmonary $\dot{V}O_2$ signal reveals numerous deviations from dynamic system linearity in oxidative function (for review, see DiMenna and Jones, 2009) and it is likely that muscle fibre type and motor unit recruitment are important factors to consider when defining these characteristics.

Aims

The general aim of this thesis is to characterise the $\dot{V}O_2$ on-response to work-to-work exercise and to investigate how that response might be influenced by altered tissue oxygenation and muscle contraction frequency. The specific purposes of this thesis are:

- 1.) To determine the influence of high-intensity priming exercise on the subsequent work-to-work $\dot{V}O_2$ response.
- 2.) To determine the influence of high-intensity priming exercise on the subsequent work-to-work [PCr] response.
- 3.) To determine the influence of a supine body posture on the work-to-work $\dot{V}O_2$ response.
- 4.) To determine the influence of extremely slow and fast pedal cadences on the work-to-work $\dot{V}O_2$ response.
- 5.) To determine the influence of high-intensity priming exercise at extreme cadences on the subsequent $\dot{V}O_2$ response to high-intensity exercise at extreme cadences.

Hypotheses

This thesis will address the following hypotheses:

- 1.) That τ_p would be longer when high-intensity cycle exercise was initiated from a moderate-intensity (M→H) compared with unloaded (U→H) baseline.
- 2.) That the performance of prior high-intensity exercise would significantly reduce τ_p , the amplitude of the \dot{V}_{O_2} slow component and the change in iEMG between two and six minutes of exercise ($\Delta iEMG_{(6-2)}$) during subsequent M→H cycle exercise.
- 3.) That the performance of prior high-intensity exercise would not influence [PCr] or \dot{V}_{O_2} kinetics during subsequent rest-to-moderate knee-extension exercise (R→M), but would reduce the fundamental phase [PCr] τ and \dot{V}_{O_2} τ_p during subsequent M→H knee-extension exercise.
- 4.) That τ_p would be similar in the supine and upright positions during unloaded to moderate-intensity cycle exercise (U→M), but significantly longer in the supine position during M→H cycle exercise.
- 5.) That τ_p would be reduced to a value similar to τ_p in the upright control condition during supine cycle exercise after the performance of prior high-intensity exercise.
- 6.) That τ_p would be similar for U→M and U→H during cycle exercise at 35 rev·min⁻¹ and similar for U→H and M→H during cycle exercise at 115 rev·min⁻¹.
- 7.) That the characteristic priming effect (reduced \dot{V}_{O_2} slow component and increased fundamental component amplitude with unchanged τ_p) would be observed during U→H cycle exercise at 35 rev·min⁻¹ regardless of the cadence employed during a prior high-intensity bout and also during U→H cycle exercise at 115 rev·min⁻¹ when prior high-intensity cycle exercise was performed at 35 rev·min⁻¹.
- 8.) That the performance of prior high-intensity cycle exercise at 115 rev·min⁻¹ would significantly reduce τ_p during subsequent U→H cycle exercise at 115 rev·min⁻¹.

Chapter 3: General Methods

General Experimental Procedures

The five investigations that comprise the experimental chapters of this thesis required the administration of 297 exercise tests that were conducted at either the exercise physiology laboratory at the University of Exeter School of Sport and Health Sciences or the magnetic resonance spectroscopy laboratory at the Peninsula Medical School. Both of these laboratories were air conditioned such that all testing took place at 18-22°C. In all cases, experimental procedures were approved by the University Ethics Committee prior to the initiation of testing.

Subjects

All subjects taking part in the investigations in this thesis volunteered to participate. Subjects were non-smokers that were free from disease and recreationally active at various levels, including regular structured exercise and/or competitive sport, although none were elite-level athletes. Subjects were instructed to report to the laboratory in a rested state, having completed no strenuous exercise within the previous 24 hours and having abstained from food, alcohol and caffeine for the preceding three hours. Testing was conducted at the same time of day (± 2 hours) for each subject and subjects were familiarised with the mode(s) of exercise and experimental procedures prior to the initiation of testing.

Informed Consent

Prior to agreeing to participate in a study, subjects were provided with a verbal explanation of the experimental procedures and an information sheet that outlined the requirements associated with their participation and the potential risks and benefits. Subjects were

assured that even though group results would be available for public inspection and individual response profiles might be presented to depict a representative response, their anonymity would be strictly preserved and all data would be securely stored such that only researchers involved in these studies could gain access. Subjects also understood that they were free to withdraw from the project at any time without disadvantage. After this thorough explanation, any questions that subjects had were answered to their satisfaction and they subsequently gave written informed consent that confirmed their willingness to participate.

Health and safety

Health and safety guidelines established by the School were recognised during all tests and great care was taken to ensure that the laboratory provided a clean and safe environment that was appropriate for exercise testing of human subjects. Ergometers, trolleys and work surfaces were cleaned using dilute Virkon disinfectant and all respiratory apparatus was similarly disinfected according to manufacturers' recommendations. Experimenters wore disposable latex gloves during blood sampling and all sharps and biohazard materials were disposed of appropriately. A proper 'cool-down' was provided upon completion of the requisite exercise challenge and subjects were allowed and encouraged to drink water *ad librium* prior to and upon completion of testing.

Measurement Procedures

Descriptive data

For all investigations, each subject's stature and mass were measured and these parameters along with age were recorded prior to the initiation of testing. For investigations that required cycle ergometer exercise, peak power output, $\dot{V}O_{2\text{peak}}$ and GET were determined

for the specific cadence(s) and body position(s) that would be investigated during the study. These measurements were made during preliminary exercise testing (see below).

Pulmonary gas exchange

During all exercise tests except for those that involved interrogation by magnetic resonance spectroscopy, pulmonary gas exchange and ventilation were measured. For the tests in Chapters 4, 7 and 8, this analysis was performed using a portable system comprised of a bidirectional digital transducer that measured inspired and expired airflow and electrochemical cell (O_2) and ND infrared (CO_2) analysers that measured expired gas concentrations (MetaMax 3B, Cortex Biophysik, Leipzig, Germany). For the tests in Chapters 5 and 6, this analysis was performed using a metabolic cart system comprised of a bidirectional “TripleV” digital transducer and differential paramagnetic (O_2) and infrared absorption (CO_2) analysers (Jaeger Oxycon Pro, Hoechberg, Germany). In all cases, the gas analysers were calibrated before each test with gases of known concentration and the volume sensor was calibrated using a 3-liter syringe (Hans Rudolph, Kansas City, MO). Subjects wore a nose clip and breathed through a low-dead-space, low-resistance mouthpiece that was connected securely to the transducer. Gas was sampled continuously via a capillary line and \dot{V}_{O_2} , \dot{V}_{CO_2} and \dot{V}_E were displayed breath-by-breath on-line once the delay between the volume and concentration signals was accounted for. After each test, raw breath-by-breath gas exchange data was exported and analysed at a later date.

Electromyography

For Chapters 4, 5, 6 and 7, the surface EMG of the *m. vastus lateralis* of the left leg (Chapters 4, 5 and 6) or the summed surface EMG of the *m. vastus lateralis* and *m. gluteus maximus* of the left leg (Chapter 7) was measured to assess neuromuscular activity and

infer muscle activation during exercise. For these measurements, the leg was initially shaved and cleaned with alcohol around the belly of the muscle and graphite snap electrodes (Unilect 40713, Unomedical, Stonehouse, Great Britain) were adhered to the prepared area in a bipolar arrangement (interelectrode distance, 40 mm) with ground electrodes positioned on nearby tissue. Elastic bandages were used to secure electrodes and wires in place and pen marks were made around electrodes to enable placement reproduction on subsequent tests. The EMG signal was recorded at 1000 Hz using a ME3000PB Muscle Tester (Mega Electronics Ltd, Finland), the bipolar signal was amplified (amplifier input impedance $> 1 \text{ M } \Omega$) and data were collected online in raw form and stored on a computer using MegaWin software (Mega Electronics Ltd, Finland).

Heart Rate

During all exercise tests except for those that involved interrogation by magnetic resonance spectroscopy, HR was measured using short-range telemetry (Polar S610, Polar Electro Oy, Kempele, Finland). For the tests in Chapters 4, 7 and 8, HR was recorded during the duration of each breath via the portable gas exchange analysis system that was used (MetaMax 3B, Cortex Biophysik, Leipzig, Germany). For the tests in Chapters 5 and 6, 5-s average values were recorded via heart rate monitor (Polar Electro Oy, Kempele, Finland). After all tests, raw HR data was exported and analysed at a later date.

³¹Phosphorous magnetic resonance spectroscopy

For Chapter 5, intramuscular metabolic responses to exercise were measured by ³¹P-MRS. For this testing, subjects were positioned prone inside the bore of a 1.5-T superconducting MR scanner with a 6-cm ³¹P transmit/receive surface coil centered over their right quadriceps muscle. Cod liver oil capsules that yield high-intensity signal points within the

image were placed adjacent to the coil and fast field echo images were acquired to ensure that the muscle was positioned correctly. After a number of pre-acquisition steps were undertaken to optimise the signal from the muscle, data acquisition began prior to exercise to establish baseline values. Data were acquired every 1.5 seconds, with a spectral width of 1500 Hz and 1000 data points. Phase cycling with four phase cycles was employed, which lead to a spectrum being acquired every 6 seconds prior to and during exercise. These spectra were analysed via peak fitting at a later date.

Near-infrared spectroscopy

For Chapters 6 and 8, a commercially-available NIRS system (model NIRO 300, Hamamatsu Photonics KK, Hiugashi-ku, Japan) was used to assess the oxygenation status of the *m. vastus lateralis* of the right leg. NIRS provides a means by which changes in oxygenated and deoxygenated [Hb+Mb] can be assessed non-invasively based upon changes in near-infrared light absorption by the tissue. The system consists of an emission probe that irradiates laser beams and a detection probe positioned several centimeters from the emission probe in an optically-dense rubber holder. Four different wavelength laser diodes provide the light source (776, 826, 845 and 905 nm) and the light returning from the tissue is detected by a photomultiplier tube in the spectrometer. For these measurements, the leg was initially shaved and cleaned with alcohol around the belly of the muscle and the probes were placed in the holder, which was secured to the skin with adhesive. Elastic bandages were used to secure the holder and wires in place and pen marks were made around the holder to enable placement reproduction on subsequent tests. Prior to beginning exercise, baseline values were established with the subject at rest with leg extended at downstroke in a seated position for upright cycling (Chapters 6 and 8) and in a supine position for supine cycling (Chapter 6). All subsequent concentration changes of

oxygenated and deoxygenated [Hb+Mb] relative to this baseline were estimated via the intensity of incident and transmitted light (recorded continuously at 2 Hz throughout exercise) and these values were averaged into one-second bins. After each test, raw NIRS data was exported and analysed at a later date.

Blood lactate concentration

During one repetition per condition for all constant-load testing, fingertip blood was sampled to determine whole blood [lactate]. Prior to drawing the initial sample for the exercise bout, the sampling site was cleaned thoroughly with alcohol and a disposable safety lancet (Safety-Lanzette, Sarstedt) was used to puncture the skin. For all samples that were subsequently drawn from this incision, initial drops of blood were wiped away and approximately 20-25 μL of free-flowing arterialised blood was collected into a microvette (Microvette CB 300, Sarstedt) and analysed using an automated lactate analyser (YSI 1500, Yellow Springs Instruments, Yellow Springs, OH, United States). The analyser was calibrated regularly by a laboratory technician in accordance with the manufacturer's guidelines. In all cases, blood was drawn in the ~ 20 seconds prior to either the subsequent increase in work rate or the cessation of exercise such that the measured values reflect end-stage ones for the specific work rate being maintained. Blood lactate accumulation ($\Delta_{\text{blood}}[\text{lactate}]$) was defined as the difference between end blood [lactate] and blood [lactate] prior to the transition to the work rate (i.e., baseline blood [lactate]).

Testing Procedures

Preliminary exercise testing

For investigations that assessed cycle ergometer exercise, preliminary testing involved the performance of 'ramp' incremental cycling test(s) to exhaustion while maintaining the

cadence(s) ($80 \text{ rev}\cdot\text{min}^{-1}$ for tests conducted in Chapters 4 and 6; 35 and $115 \text{ rev}\cdot\text{min}^{-1}$ for tests conducted in Chapters 7 and 8) and body position(s) (upright for tests conducted in Chapters 4, 6, 7 and 8; supine for tests conducted in Chapter 6) that would be used on subsequent testing. These incremental tests consisted of three minutes of pedalling at 0 W , followed by a continuous ramped increase in work rate of $30 \text{ W}\cdot\text{min}^{-1}$ until the subject was unable to continue. The termination criterion was a drop of $> 10 \text{ rev}\cdot\text{min}^{-1}$ below the prescribed cadence. An electronically-braked cycle ergometer (Lode Excalibur Sport, Groningen, The Netherlands) was used for this testing. This device controls external power output independent of pedal cadence by instantaneously adjusting flywheel resistance via electrical braking. The ergometer was calibrated regularly by a laboratory technician in accordance with the manufacturer's guidelines and the same ergometer was used for all subsequent experimental testing of the subject. Saddle and handlebar heights for upright cycling and body distance relative to crank shaft for supine cycling were recorded following the preliminary test(s) and the same settings were reproduced on all subsequent tests. Pulmonary gas exchange and heart rate were measured throughout these incremental bouts.

For the investigation that assessed knee-extension ergometer exercise, preliminary testing involved the performance of a 'step' incremental knee-extension exercise test to exhaustion while maintaining a cadence of $40 \text{ contractions}\cdot\text{min}^{-1}$. This incremental test consisted of two-minute stages with load progressed according to subject perceived exertion such that six stages would be completed prior to exhaustion. The termination criterion was the inability to maintain the prescribed cadence. A custom-designed ergometer that provided a concentric-only resistive load for each leg was used for this testing. This device allowed for the performance of rhythmic double-legged knee-extension exercise in a contralateral-

alternating manner over a distance of ~ 0.22 m. The same ergometer was used for all subsequent experimental testing of the subject.

Determination of $\dot{V}_{O_{2peak}}$ and gas exchange threshold

For the preliminary incremental cycling tests conducted in Chapters 4, 6, 7 and 8, breath-by-breath \dot{V}_{O_2} data were averaged into 10-s bins and $\dot{V}_{O_{2peak}}$ was defined as the highest 30-s rolling average value. GET was estimated from the 10-s average gas exchange data using a cluster of measures including: 1) the first disproportionate increase in \dot{V}_{CO_2} from visual inspection of individual plots of \dot{V}_{CO_2} v. \dot{V}_{O_2} (Beaver *et al.*, 1986); 2) an increase in \dot{V}_E/\dot{V}_{O_2} with no increase in \dot{V}_E/\dot{V}_{CO_2} ; 3) an increase in end-tidal O_2 tension with no fall in end-tidal CO_2 tension.

Experimental exercise testing

For all investigations, constant-load tests were used to assess \dot{V}_{O_2} on-kinetics. These tests involved an abrupt transition from a lower to higher work rate on the ergometer used for the study (cycle or knee extension; see above). For Chapters 4, 6, 7 and 8, constant-load tests were performed at work rates calculated according to the GET and peak work rates determined from the preliminary incremental test(s). (Note: Assignment of a work rate from pulmonary gas exchange data requires correction for the \dot{V}_{O_2} mean response time, which was assumed to approximate two-thirds of the ramp rate during incremental exercise (Whipp *et al.*, 1981). Therefore, GET and peak work rates used to calculate exercise intensity in Chapters 4, 6, 7 and 8 reflect work rates that are 20 W less than the work rates that were time aligned with the GET and peak \dot{V}_{O_2} during the preliminary incremental test.) For Chapter 5, constant-load tests were performed at work rates calculated according to the average iEMG measured during the stages of the preliminary incremental test.

Calculation of work rates for constant-load tests

For Chapters 4, 6 and 7, moderate-intensity work rates were calculated as a percentage of the work rate at GET (90% for the testing in Chapter 4; 95% for the testing in Chapters 6 and 7). For Chapters 4, 6, 7 and 8, high-intensity work rates were calculated as a percentage of ‘delta’ (Δ) (70% for the testing in Chapters 4 and 6; 60% for the testing in Chapters 7 and 8). (Note: Δ denotes the difference between the work rate at GET and the work rate at $\dot{V}_{O_{2peak}}$; therefore, a work rate designated at a % Δ reflects the sum of the work rate at GET and a specific increment above that work rate as indicated by the percentage.)

For Chapter 5, iEMG for each stage of the preliminary incremental test was defined as the average from 15-75 s of the two-minute stage, and this value was normalised to the iEMG MVC, which was recorded prior to the bout. Results from pilot testing indicated that loads requiring ~15 and ~30% of the iEMG MVC would be appropriate for moderate- and high-intensity knee-extension exercise, respectively; therefore, loads for the constant-load tests were prescribed accordingly.

*Gas exchange data analysis procedures**Enhancing signal-to-noise ratio*

Breath-by-breath \dot{V}_{O_2} data displays considerable inherent variability (i.e., ‘noise’) and, furthermore, outliers (errant breaths caused by coughing, swallowing, premature ending of a breath, etc.) are often present (e.g., see Figure 3.1; panel A). Consequently, prior to analysis, raw data from each test were examined to exclude data that were thought to inappropriately reflect the underlying physiology. During this process, great care was taken to only remove definitive outliers; for example, data points lying more than four standard deviations from the five-breath local rolling average (see Figure 3.1; panel B).

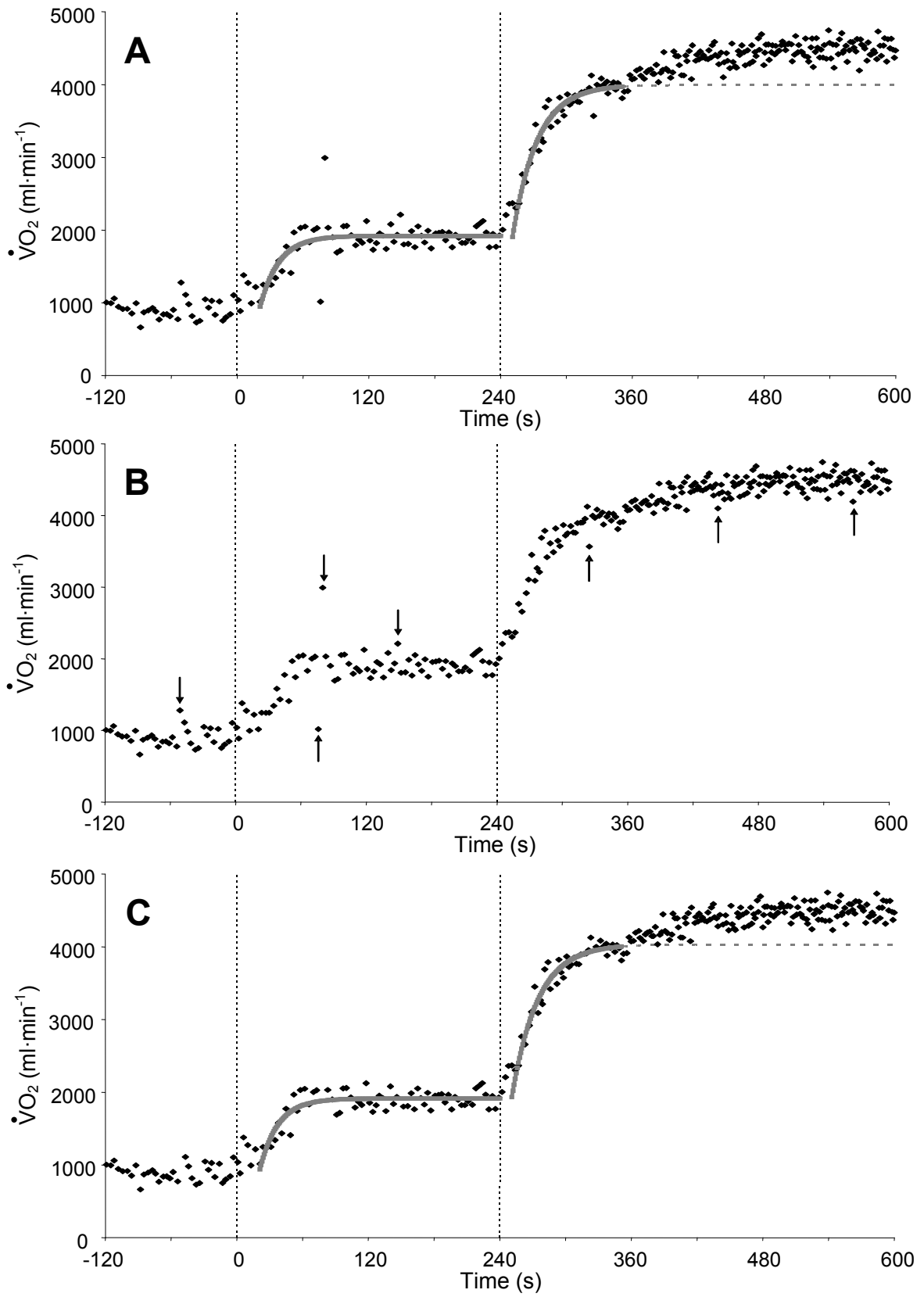

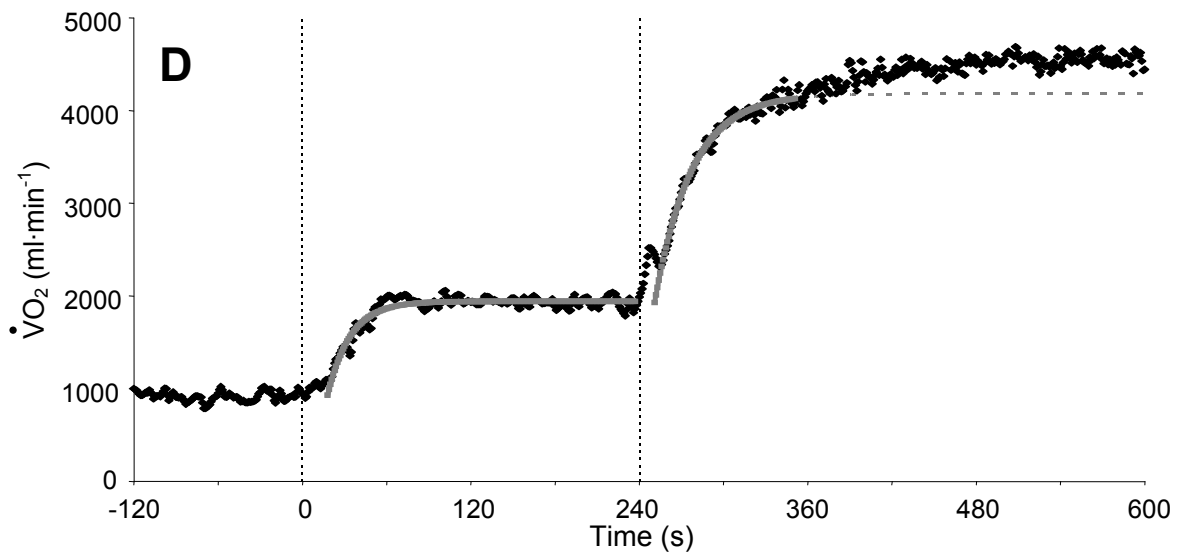

Figure 3.1: Breath-to-breath variability and occasional outliers make it challenging to attain adequate confidence in parameter estimates derived by mathematical modelling of the $\dot{V}O_2$ response. Panel A depicts breath-by-breath $\dot{V}O_2$ data collected during a single work-to-work transition for a representative subject (subject 2, work-to-work upright condition; Chapter 6). Vertical dashed lines indicate the abrupt transitions to the higher work rates (from left to right, moderate- and high-intensity, respectively). Superimposed lines over the data (for the high-intensity transition, solid prior to TD_s , dashed after TD_s) illustrate the phase II modelled fits. Conservative editing of definitive outliers (indicated by arrows in Panel B) improves the fit (Panel C); however, adequate confidence (e.g., 95% confidence intervals for τ_p estimation that are within $\sim 10\%$ of the estimated value of the parameter) are not attained until similarly edited data from three like-transitions are time aligned and ensemble averaged (Panel D; see Table 3.1).

Once this editing was complete, data were linearly interpolated using a dedicated algorithm to provide second-by-second values. This is necessary because signal-to-noise ratio can also be enhanced by averaging repeat transitions of identical trials (Lamarra *et al.*, 1987; e.g., see Figure 3.1, Panel D), but ensemble averaging in this manner necessitates the same series of data points for each set of data.

It has also been shown that breath-to-breath variability in the $\dot{V}O_2$ signal is largely independent of work rate (e.g., $\pm 200 \text{ ml}\cdot\text{min}^{-1}$) (Lamarra *et al.*, 1987); therefore, a larger

Table 3.1: Parameter estimates and 95% confidence intervals (CI; $CI = SE \cdot t_{dis}$ where SE is the standard error of the parameter estimates determined via exponential curve fitting and t_{dis} is derived from the t -distribution using 2.5% per tail) for the modelled responses depicted in Figure 3.1 (Panel A, one unedited transition; Panel C, one edited transition; Panel D, three edited averaged transitions).

	τ_p		A_p		TD_s	
	Estimate (s)	95% CI (s)	Estimate (L·min ⁻¹)	95% CI (L·min ⁻¹)	Estimate (s)	95% CI (s)
Moderate:						
1 unedited	17.4	4.3	1.043	.027	19.8	2.9
1 edited	16.7	2.7	1.030	.017	20.1	1.8
3 edited avg.	16.3	1.8	1.034	.010	17.6	1.4
High-intensity:						
1 unedited	22.5	4.0	2.090	.058	11.0	2.9
1 edited	23.6	3.9	2.128	.058	10.7	2.8
3 edited avg.	26.3	2.5	2.255	.041	11.0	1.6

response amplitude reduces the degree to which this inherent noise negatively impacts confidence in the parameter estimates. The testing regimen in Chapter 8 exclusively comprises full high-intensity transitions that force large response amplitudes and, therefore, two repeat trials were performed per condition for this testing. Conversely, the testing regimens in Chapters 4, 6 and 7 required work-to-work transitions that necessarily engender lesser response amplitudes; therefore, three repeat transitions were performed per condition for this testing. Work-to-work exercise was also investigated in Chapter 5 and the mode of exercise that was employed (concentric-only contralateral knee-extension exercise) requires less total muscle activation compared to cycle ergometer exercise; therefore, response amplitudes were exceedingly low under these circumstances (e.g., ~400 ml·min⁻¹). However, due to an inability to collect gas exchange data during the repetition that was performed under MRS interrogation, only two repeat trials could be averaged prior to modelling the \dot{V}_{O_2} data collected in this study. To alleviate concerns regarding

insufficient confidence in parameter estimates under these circumstances, each averaged \dot{V}_{O_2} response was also smoothed with a five-point rolling-average filter prior to analysis.

Mathematical modelling of \dot{V}_{O_2} data

In the five studies comprising the experimental chapters of this thesis, \dot{V}_{O_2} on-kinetics was defined via parameters derived from exponential curve fitting. Once editing, linear interpolation and averaging of the breath-by-breath data was complete and adequate signal-to-noise ratio was attained, the second-by-second files were imported into a purpose-written modelling program that described the \dot{V}_{O_2} response using a nonlinear least-square regression algorithm. This program employs an iterative process that minimises the sum of the squared error between the fitted function and the observed data. Prior to this curve fitting, the first 20 s of data after the onset of exercise (Chapters 4, 6, 7, 8) or all data prior to the inflection point that signals the phase I/phase II interface (Whipp *et al.*, 1982) (Chapter 5) were deleted to ensure that the cardiodynamic phase of the \dot{V}_{O_2} response did not contaminate the phase II fit. For moderate-intensity exercise (Chapters 5, 6 and 7), a single-exponential model was used to characterise the \dot{V}_{O_2} response. For high-intensity exercise (all experimental chapters), both a single- and bi-exponential model were used and the better fitting model was determined by comparing residual sum of squared error values associated with the fit. In all cases, the bi-exponential model provided a better representation of the \dot{V}_{O_2} response to high-intensity exercise. The single- (equation 1) and bi- (equation 2) exponential models are described in the following equations:

$$\dot{V}_{O_2}(t) = \dot{V}_{O_2 \text{ baseline}} + A_p(1 - e^{-(t-TD_p)/\tau_p}) \quad (\text{Eqn. 1})$$

$$\dot{V}_{O_2}(t) = \dot{V}_{O_2 \text{ baseline}} + A_p(1 - e^{-(t-TD_p)/\tau_p}) + A_s(1 - e^{-(t-TD_s)/\tau_s}) \quad (\text{Eqn. 2})$$

where $\dot{V}_{O_2}(t)$ represents the absolute \dot{V}_{O_2} at any given time t ; $\dot{V}_{O_{2\text{baseline}}}$ represents the mean \dot{V}_{O_2} in the baseline (i.e., pre-transition) period; A_p , TD_p , and τ_p represent the amplitude, time delay, and time constant, respectively, describing the phase II increase in \dot{V}_{O_2} above baseline; and A_s , TD_s , and τ_s represent the amplitude of, time delay before the onset of, and time constant describing the development of, the \dot{V}_{O_2} slow component, respectively. However, because the asymptotic value of the exponential term describing the \dot{V}_{O_2} slow component may represent a higher value than is actually reached at the end of the exercise, the actual amplitude of the slow component at the end of exercise was defined as A_s' . The functional gains of the fundamental and overall \dot{V}_{O_2} response were computed by dividing response-phase amplitudes by the increase in work rate that forced the response and the amplitude of the slow component was also described relative to the entire \dot{V}_{O_2} response and, in some studies, by calculating the difference between \dot{V}_{O_2} at minute 2 and end-exercise (i.e., $\Delta\dot{V}_{O_{2(6-2)}}$). Furthermore, the \dot{V}_{O_2} MRT was determined in some studies by fitting a single exponential without time delay to all data from $t = 0$. This parameter provides information on the 'overall' \dot{V}_{O_2} kinetics with no distinction made for various phases of the response and can be useful for 'estimating' the O_2 deficit during exercise (e.g., see Chapter 4). Finally, in Chapter 5, the initial rate of change of \dot{V}_{O_2} ($d\dot{V}_{O_2}/dt$) was calculated as A_p/τ_p .

Other data analysis procedures

Filtering and averaging of electromyographic data

In Chapters 4, 5, 6 and 7, the raw EMG data were filtered with a 20 Hz high-pass second-order Butterworth filter to remove contamination from movement artefacts. The signal was then rectified and low-pass filtered at a frequency of 50 Hz to produce a linear envelope. The iEMG values so derived were averaged for either 15-s (Chapters 4, 6 and 7) or 60-s (Chapter 5) intervals throughout exercise and these values were normalised to either the

average measured during the unloaded cycling phase prior to the initial increase in work rate (Chapters 4, 6 and 7) or an MVC performed prior to the bout (Chapter 5). These normalised average iEMG values were then time aligned and ensemble averaged across repeat trials of identical exercise bouts and from these averaged files, iEMG at discrete time points (e.g., minute 2 or minute 6) and the change in iEMG between time points (e.g., $\Delta iEMG_{6,2}$) was determined.

Mathematical modelling of heart rate data

To provide indirect information on cardiac output dynamics, the HR response to exercise was modelled in Chapters 4 and 8. For this analysis, HR data collected during the duration of each breath were linearly interpolated to provide second-by-second values such that data from identical repeat bouts could be time-aligned to the start of exercise and ensemble averaged. A single-exponential model similar to the one used to fit the \dot{V}_{O_2} data (see equation 1 above) was also employed to characterise the HR response; however, this model commenced at exercise onset (i.e., TD was fixed at $t = 0$). Furthermore, to avoid contamination by any HR ‘slow component’ (i.e., a HR response accompanying the \dot{V}_{O_2} slow component), the fitting window for high-intensity exercise was constrained at the time delay before the onset of the \dot{V}_{O_2} slow component (see above). In Chapter 8, the HR slow component was determined by calculating the HR increase above this fundamental HR response amplitude at end exercise.

Peak fitting of ^{31}P phosphorous magnetic resonance spectra

In Chapter 5, the spectra acquired via ^{31}P -MRS were quantified by peak fitting, with assumption of prior knowledge, using jMRUI (version 2) software and the AMARES fitting algorithm. Spectra were fitted according to the assumption that Pi, PCr, α -ATP (two

peaks, amplitude ratio 1:1), γ -ATP (two peaks, amplitude ratio 1:1), β -ATP (three peaks, amplitude ratio 1:2:1) and phosphodiester peaks were present. In all cases, relative amplitudes were corrected for partial saturation due to the repetition time relative to T1 via an unsaturated spectra acquired prior to exercise. Intracellular pH was calculated using the chemical shift of the P_i spectral peak relative to the PCr peak (Taylor *et al.*, 1983).

Mathematical modelling of phosphocreatine concentration data

In Chapter 5, [PCr] data (expressed as a percent change relative to the initial resting baseline, which was assumed to represent 100%) was modelled similar to HR as described above. However, in this case, only one set of data was collected and for high-intensity exercise, the fitting window was constrained to the time point at which a departure from fundamental mono-exponentiality occurred (as judged from visual inspection of a plot of the residuals of the fit). The initial rate of change of [PCr] was determined in the same manner as \dot{V}_{O_2} (see above) and the [PCr] slow component was calculated as the difference between end-exercise [PCr] (i.e., the average over the final 30 s of exercise) and the value indicated by equation 1 at $t = 360$. The [PCr] slow component was also described relative to the entire [PCr] response and as $\Delta[PCr]_{(6-2)}$.

Mathematical modelling of deoxyhaemoglobin concentration data

In Chapters 6 and 8, [HHb] data were modelled similar to \dot{V}_{O_2} as described above. Specifically, the single- and bi-exponential models (Equations 1 and 2) were used to fit the [HHb] data for moderate- and high intensity exercise, respectively. However, in this case, the fitting window commenced at either $t = 0$ (Chapter 8) or from the first datum that was one standard deviation above the baseline mean after initiation of the transition (Chapter 6). Information regarding dynamics specific to the fundamental phase of the [HHb] response

was derived from the sum of the fundamental τ and TD ($[\text{HHb}] \tau + \text{TD}$) in Chapter 6 and from an MRT determined by a single exponential curve without time delay that was fit to the fundamental region of the response in Chapter 8. The ratio of $[\text{HHb}]$ amplitude to $\dot{V}\text{O}_2$ amplitude ($\Delta[\text{HHb}]/\Delta\dot{V}\text{O}_2$) was used as an index of O_2 extraction during various phases of the response and the $[\text{HHb}]$ slow component was defined relative to the overall $[\text{HHb}]$ amplitude. Finally, in Chapter 6, a single exponential curve without time delay was fit to the high-intensity $[\text{HHb}]$ data from exercise onset to end to derive an MRT that provided information on the overall $[\text{HHb}]$ kinetics with no distinction for phases of the response.

Analysis of oxyhaemoglobin concentration data

Prior research indicates that $[\text{HbO}_2]$ responses do not approximate an exponential (DeLorey *et al.*, 2007). Consequently, NIRS-derived $[\text{HbO}_2]$ data collected during the tests performed in Chapters 6 and 8 were not modelled. However, baseline and end-exercise $[\text{HbO}_2]$ were determined (Chapter 8) and the sum of $[\text{HbO}_2]$ and $[\text{HHb}]$ at baseline and at 60-second intervals throughout exercise was used to provide an estimate of changes in total haemoglobin ($[\text{HHb}_{\text{tot}}]$) (Chapter 6).

Statistical methods

All statistical analyses within the experimental chapters of this thesis were conducted with either Microsoft Excel (paired t -tests and correlations) or the Statistical Package for Social Sciences (one-way repeated measures analysis of variance). Specific information regarding the particular statistical tests that were employed for the different investigations is provided within each of the experimental chapters. Before any statistical tests were carried out, the data were screened for normal distribution using standard procedures. Statistical significance was accepted at $P < 0.05$. All data are presented as means \pm SD.

J Appl Physiol 105: 538–546, 2008.
First published May 29, 2008; doi:10.1152/jappphysiol.90357.2008.

Influence of priming exercise on pulmonary O₂ uptake kinetics during transitions to high-intensity exercise from an elevated baseline

Fred J. DiMenna,¹ Daryl P. Wilkerson,¹ Mark Burnley,² and Andrew M. Jones¹

¹*School of Sport and Health Sciences, University of Exeter, Exeter, Devon; and* ²*Department of Sport and Exercise Science, Aberystwyth University, Ceredigion, United Kingdom*

Submitted 4 March 2008; accepted in final form 23 May 2008

DiMenna FJ, Wilkerson DP, Burnley M, Jones AM. Influence of priming exercise on pulmonary O₂ uptake kinetics during transitions to high-intensity exercise from an elevated baseline. *J Appl Physiol* 105: 538–546, 2008. First published May 29, 2008; doi:10.1152/jappphysiol.90357.2008.—It has been suggested that the slower O₂ uptake ($\dot{V}O_2$) kinetics observed when exercise is initiated from an elevated baseline metabolic rate are linked to an impairment of muscle O₂ delivery. We hypothesized that “priming” exercise would significantly reduce the phase II time constant (τ) during subsequent severe-intensity cycle exercise initiated from an elevated baseline metabolic rate. Seven healthy men completed exercise transitions to 70% of the difference between gas exchange threshold (GET) and peak $\dot{V}O_2$ from a moderate-intensity baseline (90% GET) on three occasions in each of the “unprimed” and “primed” conditions. Pulmonary gas exchange, heart rate, and the electromyogram of *m. vastus lateralis* were measured during all tests. The phase II $\dot{V}O_2$ kinetics were slower when severe exercise was initiated from a baseline of moderate exercise compared with unloaded pedaling (mean \pm SD τ , 42 \pm 15 vs. 33 \pm 8 s; $P < 0.05$), but were not accelerated by priming exercise (42 \pm 17 s; $P > 0.05$). The amplitude of the $\dot{V}O_2$ slow component and the change in electromyogram from minutes 2 to 6 were both significantly reduced following priming exercise ($\dot{V}O_2$ slow component: from 0.47 \pm 0.09 to 0.27 \pm 0.13 l/min; change in integrated electromyogram between 2 and 6 min: from 51 \pm 35 to 26 \pm 43% of baseline; $P < 0.05$ for both comparisons). These results indicate that the slower phase II $\dot{V}O_2$ kinetics observed during transitions to severe exercise from an elevated baseline are not altered by priming exercise, but that the reduced $\dot{V}O_2$ slow component may be linked to changes in muscle fiber activation.

oxygen uptake kinetics; phase II time constant; oxygen uptake slow component; work-to-work transition

AFTER A SHORT DELAY, PULMONARY oxygen uptake ($\dot{V}O_2$) rises exponentially when external work rate is increased during cycle ergometer exercise (58, 60). The time constant (τ) describing this “fundamental” (phase II) response has been shown to closely reflect the kinetics of O₂ consumption in the contracting muscles (1, 22). With appropriate caveats, the study of pulmonary $\dot{V}O_2$ kinetics can, therefore, provide useful insight into the factors that regulate and/or limit muscle oxidative metabolism in the transition from one work rate to another (59). This information is important because slow $\dot{V}O_2$ kinetics (as is observed in older age, deconditioning, and a variety of disease states) obligate a greater rate of substrate-level phosphorylation, resulting in a greater perturbation to muscle homeostasis and a reduction in exercise tolerance (29).

The phase II τ has been reported to be greater (i.e., the $\dot{V}O_2$ kinetics are slower) when a step transition to a higher work rate is initiated from a metabolic rate that exceeds that recorded during “unloaded” pedaling (5, 15, 25, 26, 40, 61, 62). For example, the phase II τ has been reported to be ~60% longer when severe-intensity exercise commences from a moderate-intensity work rate rather than from unloaded pedaling (61). The cause of the slower $\dot{V}O_2$ kinetics during such “work-to-work” transitions is unclear. However, it has been suggested that the altered balance between parasympathetic and sympathetic control of heart rate (HR) (and thus cardiac output) might reduce muscle O₂ delivery and restrict the $\dot{V}O_2$ kinetics during work-to-work transitions (25, 26). Another possible explanation for the slower $\dot{V}O_2$ kinetics during work-to-work transitions is that they reflect the metabolic properties of the muscle fiber pool contributing to force production (5, 31, 61, 62). This will be dictated by Henneman’s “size principle” (24), which posits that fibers are recruited in an orderly fashion, with smaller, more oxidative fibers recruited first. There is evidence that fibers that are higher in the recruitment hierarchy, which would be isolated in a work-to-work transition, have slower $\dot{V}O_2$ kinetics as well as a greater O₂ cost of contraction relative to lower order fibers (12, 50, 64).

“Priming” exercise has been used extensively as an intervention to test the hypothesis that $\dot{V}O_2$ kinetics are rate limited by O₂ availability (29), with it having been demonstrated that prior high-intensity exercise increases muscle blood flow and indexes of muscle oxygenation before and during subsequent exercise (6, 13, 14, 19, 31, 35). Priming exercise typically results in an “overall” speeding of $\dot{V}O_2$ kinetics during subsequent high-intensity exercise [as assessed with the mean response time (MRT); Refs. 9, 21, 39]. This speeding is generally attributable to a reduction in the amplitude of the so-called “ $\dot{V}O_2$ slow component” and is often associated with an increased amplitude of the $\dot{V}O_2$ fundamental component (3, 6–8, 17, 32, 55, 63). However, a reduction in the phase II τ has also been reported in some cases (13, 23, 27).

It has been proposed that the $\dot{V}O_2$ slow component is related to an alteration in fiber recruitment (possibly the progressive activation of less efficient high-order fibers) as heavy/severe exercise proceeds (2, 16, 36, 37, 46, 52, 56). However, the emergence of the $\dot{V}O_2$ slow component at ~120 s of high-intensity exercise might also reflect the existence of much slower $\dot{V}O_2$ kinetics in high-order fibers that are recruited at, or close to, the onset of exercise (44, 61). Priming exercise might augment fiber recruitment during the initial stages of subse-

Address for reprint requests and other correspondence: A. M. Jones, School of Sport and Health Sciences, St. Luke’s Campus, Univ. of Exeter, Heavitree Rd., Exeter, Devon EX1 2LU, United Kingdom (e-mail: a.m.jones@exeter.ac.uk).

The costs of publication of this article were defrayed in part by the payment of page charges. The article must therefore be hereby marked “advertisement” in accordance with 18 U.S.C. Section 1734 solely to indicate this fact.

quent exercise, thereby attenuating the need for further fiber recruitment (6, 10) and/or speed the kinetics in the initially recruited fibers by alleviating any local blood flow to metabolic rate heterogeneity (21). In either case, an increased $\dot{V}O_2$ fundamental component amplitude and a reduced $\dot{V}O_2$ slow component would be anticipated, with the latter being associated with a reduction in neuromuscular activity [as reflected in the integrated electromyogram (iEMG)]. However, a reduction in the phase II τ would only be expected if an O₂ delivery limitation, extant in the control condition, were resolved by the priming intervention.

From the above, it is clear that using priming exercise in conjunction with the work-to-work model is potentially useful for exploring the mechanistic bases to both the slower phase II $\dot{V}O_2$ kinetics that are apparent during work-to-work exercise transitions and the $\dot{V}O_2$ slow-component phenomenon that is present during heavy/severe exercise. The results of such a study potentially have implications for understanding, and resolving, the slow $\dot{V}O_2$ kinetics that are evident in a number of patient populations and that have been suggested to be related, at least in part, to inadequate muscle O₂ delivery (46). The purpose of the present investigation was, therefore, to determine the influence of priming exercise on $\dot{V}O_2$ kinetics and neuromuscular activation during moderate-to-severe-intensity exercise transitions. We hypothesized that the phase II τ would be longer when severe exercise was initiated from a baseline of moderate exercise compared with a baseline of unloaded pedaling. We further hypothesized that prior severe-intensity priming exercise would 1) significantly reduce the phase II τ ; and 2) significantly reduce both the amplitude of the $\dot{V}O_2$ slow component and the change in iEMG between 2 and 6 min (Δ iEMG₆₋₂) during a subsequent moderate-to-severe exercise transition.

METHODS

Subjects. Seven male subjects (mean \pm SD age 31 ± 8 yr, stature 1.80 ± 0.06 m, mass 83.2 ± 4.9 kg) volunteered and gave written, informed consent to participate in this study, which had been approved by the local Research Ethics Committee. The subjects were all recreationally active and were familiar with the exercise mode and experimental procedures used in the present study. On test days, subjects were instructed to report to the laboratory in a rested state, having completed no strenuous exercise within the previous 24 h, and having abstained from food, alcohol, and caffeine for the preceding 3 h.

Experimental procedures. All testing was completed in an air-conditioned laboratory at a temperature of $21 \pm 2^\circ\text{C}$. The subjects visited the laboratory on seven occasions over a 4-wk period to perform exercise tests on an electronically braked cycle ergometer (Lode Excalibur Sport, Groningen, the Netherlands). Testing was conducted at the same time of day (± 2 h) for each subject. On the first visit, the subjects completed a ramp incremental exercise test for determination of peak $\dot{V}O_2$ ($\dot{V}O_{2\text{peak}}$) and gas exchange threshold (GET). On each of six subsequent visits, subjects completed bouts of severe-intensity exercise (at a work rate calculated to require 70% of the difference between the GET and $\dot{V}O_{2\text{peak}}$, i.e., 70% " Δ "), initiated from a baseline of moderate-intensity exercise (90% GET). The protocol is illustrated in Fig. 1. In M \rightarrow S Unprimed (M, moderate intensity; S, severe intensity), the work-to-work transition was completed in the absence of any prior exercise; in M \rightarrow S Primed, the work-to-work transition was preceded by a bout of severe-intensity exercise (70% Δ) (U \rightarrow S, where U is unloaded) and a rest period of 5 min. Each of the two conditions was presented to subjects three

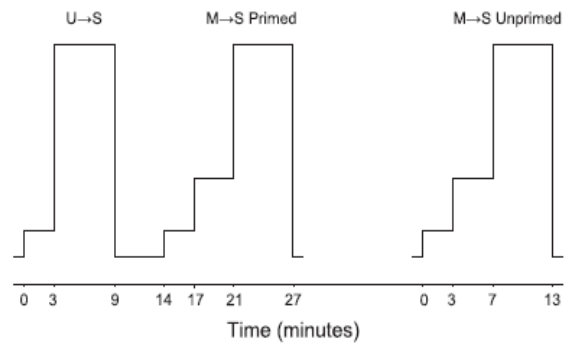

Fig. 1. Schematic illustration of the experimental protocol. U \rightarrow S involved 3 min of unloaded cycling followed by an abrupt transition to a severe-intensity work rate. M \rightarrow S Unprimed and M \rightarrow S Primed each involved 3 min of unloaded cycling, followed by 4 min of moderate-intensity exercise, and then 6 min of severe-intensity exercise. M \rightarrow S Primed was performed after U \rightarrow S and 5 min of rest.

times in random order, and each laboratory visit was separated by at least 48 h.

The ramp incremental exercise test consisted of 3 min of pedaling at 0 W, followed by a continuous ramped increase in work rate of 30 W/min until the subject was unable to continue. The subjects cycled at 80 rpm, and saddle and handlebar heights were recorded. The same pedal rate and settings were reproduced on subsequent tests. The $\dot{V}O_{2\text{peak}}$ was defined as the highest 30-s mean value recorded before the subject's volitional termination of the test; "secondary criteria" were not used to verify that a "true" maximum had been obtained (47). The GET was determined from a cluster of measures, including 1) the first disproportionate increase in carbon dioxide output ($\dot{V}CO_2$) from visual inspection of individual plots of $\dot{V}CO_2$ vs. $\dot{V}O_2$; 2) an increase in expiratory ventilation (\dot{V}_E)/ $\dot{V}O_2$ with no increase in $\dot{V}_E/\dot{V}CO_2$; 3) an increase in end-tidal O₂ tension with no fall in end-tidal CO₂ tension. The work rates that would require 90% of the GET (moderate exercise, M) and 70% of the difference (Δ) between the GET and $\dot{V}O_{2\text{peak}}$ (severe exercise, S) were estimated, with account taken of the MRT of the $\dot{V}O_2$ response to ramp exercise (assumed to approximate two-thirds of the ramp rate, i.e., 20 W) (57). These work rates were subsequently applied during the work-to-work transitions completed in both the unprimed and primed state.

The subjects returned to the laboratory on six occasions to perform one of the following protocols: 1) 3 min of "unloaded" cycling at 20 W, 4 min of moderate-intensity cycling, and 6 min of severe-intensity cycling; and 2) 3 min of "unloaded" cycling at 20 W, 6 min of severe-intensity cycling, 5 min of passive rest, 3 min of "unloaded" cycling at 20 W, 4 min of moderate-intensity cycling, and 6 min of severe-intensity cycling (Fig. 1). The first protocol provided data for transitions to severe-intensity exercise from a moderate-intensity baseline without priming (M \rightarrow S Unprimed). The second protocol provided data for transitions to severe-intensity exercise from an unloaded baseline (U \rightarrow S), and from a moderate-intensity baseline after priming (M \rightarrow S Primed). The $\dot{V}O_2$ responses from like transitions were averaged before any analysis being performed to enhance the signal-to-noise ratio and improve confidence in the parameters derived from the model fits (38, 59).

During all tests, pulmonary gas exchange and ventilation were measured continuously using a portable gas analysis system (MetaMax 3B, Cortex Biophysik, Leipzig, Germany). A DVT turbine digital transducer measured inspired and expired airflow, while an electrochemical cell O₂ analyzer and ND infrared CO₂ analyzer simultaneously measured inspired and expired gases. Subjects wore a nose clip and breathed through a low-dead space, low-resistance mouthpiece that was securely attached to the volume transducer. The inspired and

expired gas volume and gas concentration signals were continuously sampled via a capillary line connected to the mouthpiece. The gas analyzers were calibrated before each test with gases of known concentration, and the turbine volume transducer was calibrated using a 3-liter syringe (Hans Rudolph, Kansas City, MO). Pulmonary gas exchange and ventilation were calculated and displayed breath by breath. HR was measured every breath during all tests using short-range radiotelemetry (Polar S610, Polar Electro Oy, Kempele, Finland). During one of the three trials under each condition, a blood sample from a fingertip was collected into a capillary tube over the 20 s preceding any step transition in work rate and within the last 20 s of exercise and subsequently analyzed to determine blood [lactate] (where brackets denote concentration) (YSI 1500, Yellow Springs Instruments, Yellow Springs, OH). Blood lactate accumulation (Δ blood [lactate]) was calculated as the difference between blood [lactate] at end exercise and blood [lactate] at baseline.

Neuromuscular activity of the *m. vastus lateralis* of the left leg was measured using bipolar surface EMG. The leg was initially shaved and cleaned with alcohol around the belly of the muscle, and graphite snap electrodes (Unilect 40713, Unomedical, Stonehouse, UK) were adhered to the prepared area in a bipolar arrangement (interelectrode distance: 40 mm). A ground electrode was positioned on the *rectus femoris* equidistant from the active electrodes. The sites of electrode placement (20 cm superior to the lateral tibial head) were chosen according to the recommendations provided in the EMG software (Mega Electronics). To secure electrodes and wires in place and to minimize movement during cycling, an elastic bandage was wrapped around the subject's leg. Pen marks were made around the electrodes to enable reproduction of the placement in subsequent tests. The EMG signal was recorded using a ME3000PB Muscle Tester (Mega Electronics).

EMG measurements at a sampling frequency of 1,000 Hz were recorded throughout all exercise tests. The bipolar signal was amplified (amplifier input impedance > 1 M Ω), and data were collected online in raw form and stored on a personal computer using MegaWin software (Mega Electronics). The raw EMG data were subsequently exported as an ASCII file and digitally filtered using Labview 8.2 (National Instruments, Newbury, UK). Initially, the signals were filtered with a 20-Hz high-pass, second-order Butterworth filter to remove contamination from movement artifacts. The signal was then rectified and low-pass filtered at a frequency of 50 Hz to produce a linear envelope. The average iEMG was calculated for 15-s intervals throughout exercise, with these values normalized to the average measured during 15–180 s of unloaded cycling before the initial transition. Therefore, all iEMG data are presented as a percentage of the initial unloaded cycling phase. Data from repeat trials were averaged, and Δ iEMG₆₋₂ was defined as the difference between the average iEMG over the last 15 s of exercise and the average from 105–120 s.

Data analysis procedures. The breath-by-breath V_{O₂} data from each test were initially examined to exclude errant breaths caused by coughing, swallowing, sighing, etc., and those values lying more than 4 SDs from the local mean (defined using a five-breath rolling average) were removed. The breath-by-breath data were subsequently linearly interpolated to provide second-by-second values, and, for each individual, identical repetitions from the three conditions were time aligned to the start of exercise and ensemble averaged. The first 20 s of data after the onset of exercise (i.e., the phase I response) were deleted (59, 60), and a nonlinear least squares algorithm was used to fit the data, as described in the following biexponential equation:

$$\dot{V}_{O_2}(t) = \dot{V}_{O_{2\text{baseline}}} + A_p [1 - e^{-(t-TD_p)/\tau_p}] + A_s [1 - e^{-(t-TD_s)/\tau_s}]$$

where $\dot{V}_{O_2}(t)$ is the absolute V_{O₂} at a given time t , $\dot{V}_{O_{2\text{baseline}}}$ is the mean V_{O₂} in the baseline period; A_p , TD_p , and τ_p are the amplitude, time delay, and time constant, respectively, describing the phase II

increase in V_{O₂} above baseline; and A_s , TD_s , and τ_s are the amplitude of, time delay before the onset of, and time constant describing the development of the V_{O₂} slow component, respectively. An iterative process was used to minimize the sum of the squared errors between the fitted function and the observed values. $\dot{V}_{O_{2\text{baseline}}}$ was defined as the mean V_{O₂} measured over the final 90 s of exercise preceding the step transition to severe exercise. The end-exercise V_{O₂} was defined as the mean V_{O₂} measured over the final 30 s of severe exercise. The absolute A_p was defined as the sum of $\dot{V}_{O_{2\text{baseline}}}$ and A_p . Because the asymptotic value (A_s) of the exponential term describing the V_{O₂} slow component may represent a higher value than is actually reached at the end of the exercise, the actual amplitude of the V_{O₂} slow component at the end of exercise was defined as A'_s . The amplitude of the slow component was also described relative to the entire V_{O₂} response.

To provide information on the “overall” V_{O₂} kinetics, with no distinction made for the various phases of the response, we also fitted a single-exponential curve without time delay to the data from the onset to the end of exercise. The MRT so derived was used to calculate the O₂ deficit (O₂D) using the equation:

$$O_2D = MRT \cdot \Delta V_{O_2}$$

In addition, for all three conditions, the functional “gain” of the phase II V_{O₂} response was computed by dividing the asymptotic A_p response by the Δ work rate. The functional gain of the entire response was calculated in a similar manner.

We also modeled the HR response to exercise in each of the three conditions. For this analysis, breath-by-breath data were linearly interpolated to provide second-by-second values, and, for each individual, identical repetitions from the three conditions were time aligned to the start of exercise and ensemble averaged. A nonlinear least squares monoexponential model without time delay was used to fit the data, with the fitting window commencing at $t = 0$ and constrained at the time delay before the onset of the V_{O₂} slow component (see above). The phase II HR τ so derived provides information on the overall response dynamics in the absence of any HR “slow component”.

Statistics. The parameters derived from the modeling of the V_{O₂} and HR data and the EMG data were analyzed using one-way repeated-measures analysis of variance with Fisher's least significant difference tests, as appropriate, to identify the location of statistically significant differences between the three conditions. Paired t -tests were used to compare kinetics parameters between V_{O₂} and HR within conditions. Paired t -tests were also used to compare the average iEMG at 120 s with the average at end exercise within conditions. Pearson product-moment correlation coefficients were used to assess the relationships between changes in the parameters of the V_{O₂} kinetics, HR kinetics, and iEMG response. Significance was accepted at $P < 0.05$. Results are reported as means \pm SD.

RESULTS

The subjects' V_{O_{2peak}} was 45 ± 5 ml·kg⁻¹·min⁻¹, with the GET occurring at 20 ± 4 ml·kg⁻¹·min⁻¹ ($46 \pm 6\%$ V_{O_{2peak}}). The peak work rate attained in the incremental test was 359 ± 42 W, and the work rate at the GET was 102 ± 26 W. The work rates calculated for moderate and severe exercise were 92 ± 23 and 266 ± 38 W, respectively.

Blood [lactate] and HR. The baseline blood [lactate] was significantly greater for M \rightarrow S Primed compared with the other two conditions (U \rightarrow S, 0.6 ± 0.2 ; M \rightarrow S Unprimed, 1.2 ± 0.2 ; M \rightarrow S Primed, 3.5 ± 1.7 mM; $P < 0.05$). There was no significant difference in Δ blood [lactate] between the three conditions (U \rightarrow S, 5.1 ± 1.5 ; M \rightarrow S Unprimed, 5.1 ± 1.1 ; M \rightarrow S Primed, 3.6 ± 1.6 mM), although it tended to be lower

in M→S Primed compared with the other two conditions ($P = 0.08$). The baseline HR was significantly different between the three conditions (79 ± 6 , 98 ± 10 , and 116 ± 10 beats/min for U→S, M→S Unprimed, and M→S Primed, respectively; Table 1), and these differences persisted during exercise (Fig. 2). The pertinent parameters of the HR kinetics in each of the three conditions are reported in Table 1, and the group mean HR response at 30-s intervals is illustrated in Fig. 2. The HR phase II τ was similar between the three conditions (U→S, 37 ± 14 s; M→S Unprimed, 36 ± 17 s; M→S Primed, 42 ± 12 s; Table 1).

$\dot{V}O_2$ kinetics. The parameters of the $\dot{V}O_2$ response in each of the three conditions are reported in Table 2 and are illustrated for a representative subject in Fig. 3. As per the experimental design, the baseline $\dot{V}O_2$ was significantly higher for the M→S transitions compared with the U→S transition; however, the baseline $\dot{V}O_2$ was also significantly higher for the M→S Primed compared with the M→S Unprimed condition. The phase II τ was significantly longer for the M→S transitions compared with the U→S transition ($P < 0.05$), but there was no significant difference between the M→S Unprimed and M→S Primed conditions (U→S, 33 ± 8 s; M→S Unprimed, 42 ± 15 s; M→S Primed, 42 ± 17 s; Table 2). The change (slowing) of the $\dot{V}O_2$ phase II τ between U→S and M→S Unprimed was not significantly correlated with the change in HR kinetics ($r = 0.38$). The A_p was significantly lower for both M→S transitions compared with the U→S transition. However, phase II gain was significantly greater for M→S Primed compared with U→S.

The $\dot{V}O_2$ slow component was greatest for U→S, least for M→S Primed, and intermediate for M→S Unprimed, with all conditions significantly different from one another (U→S, 0.62 ± 0.20 l/min; M→S Unprimed, 0.47 ± 0.09 l/min; M→S Primed, 0.27 ± 0.13 l/min; Table 2). The MRT was significantly longer in M→S Unprimed compared with U→S, but there was no difference between M→S Primed and U→S. The end-exercise $\dot{V}O_2$ was not significantly different between conditions. The end-exercise gain was significantly greater in M→S Unprimed compared with U→S, but was significantly reduced by priming exercise, such that there was no difference between M→S Primed and U→S (Fig. 4). When expressed in absolute terms, there was no significant difference in O₂ deficit between U→S and M→S Unprimed, but the O₂ deficit in M→S Primed was significantly lower than in the two other conditions. However, relative to the increase in work rate, O₂ deficit was significantly greater for M→S Unprimed compared with U→S and M→S Primed.

Table 1. Heart rate kinetics during U→S, M→S Unprimed, and M→S Primed

	U→S	M→S Unprimed	M→S Primed
Baseline heart rate, beats/min	79±6	98±10*	116±10*†
End-exercise heart rate, beats/min	159±10	159±11	165±11*†
Phase II heart rate τ , s	37±14	36±17	42±12

Values are means \pm SD. U→S, unloaded to severe exercise; M→S Unprimed, moderate to severe exercise unprimed; M→S Primed, moderate to severe exercise primed; τ , time constant. *Significantly different from U→S condition ($P < 0.05$). †Significantly different from M→S Unprimed condition ($P < 0.05$).

iEMG. For U→S and M→S Unprimed, the mean iEMG at the end of exercise was significantly greater than the value measured at 120 s of exercise. However, for M→S Primed, there was no significant difference in the mean iEMG at the end of exercise compared with that at 120 s of exercise. The $\Delta iEMG_{6-2}$ during severe exercise was significantly lower in M→S Primed compared with the other two conditions (54 ± 43 , 51 ± 35 , and $26 \pm 43\%$ increase relative to the baseline value for U→S, M→S Unprimed, and M→S Primed, respectively). The group mean iEMG response at minutes 2 and 6 and the group mean $\Delta iEMG_{6-2}$ for the three conditions are illustrated in Fig. 5.

DISCUSSION

The principal original findings of this investigation were that the performance of severe-intensity priming exercise 1) did not alter the phase II τ , but 2) did significantly reduce both the amplitude of the $\dot{V}O_2$ slow component and the $\Delta iEMG_{6-2}$, during severe-intensity exercise initiated from a moderate-intensity baseline. These results indicate that the slower phase II $\dot{V}O_2$ kinetics observed during moderate-to-severe exercise transitions are not related to a muscle O₂ delivery limitation. The results also suggest that the reduced $\dot{V}O_2$ slow component observed following priming exercise is linked to altered motor unit recruitment patterns.

Consistent with our first hypothesis, the phase II $\dot{V}O_2$ kinetics were slower when severe-intensity cycle exercise was initiated from a baseline of moderate-intensity cycling compared with a baseline of unloaded cycling: the phase II τ was $\sim 27\%$ longer during M→S Unprimed compared with U→S. Similar results have been reported previously. For example, Wilkerson and Jones (62) reported that initiating heavy-intensity cycling from a moderate-exercise baseline lengthened the phase II τ from 27 to 48 s. In an earlier study, investigating severe-intensity cycling (requiring $\sim 100\%$ $\dot{V}O_{2peak}$), Wilkerson and Jones (61) reported that the phase II τ became progressively longer when the transition was initiated from a baseline of light, moderate, or heavy exercise. Slower phase II $\dot{V}O_2$ kinetics have also been reported during exercise transitions within the upper compared with the lower region of the moderate-intensity domain (5, 40) and when moderate exercise commences from very light exercise compared with rest (25, 26). Moreover, markedly slower intramuscular [phosphocreatine] kinetics have been reported when high-intensity, knee-extension exercise transitions were initiated from a moderate-intensity exercise baseline compared with rest (31). Since the muscle [phosphocreatine] kinetics and pulmonary $\dot{V}O_2$ kinetics demonstrate similar temporal characteristics (52), these latter data indicate that the mechanism responsible for the slower phase II $\dot{V}O_2$ kinetics in work-to-work transitions reside within the contracting muscles.

It has been suggested that slower phase II $\dot{V}O_2$ kinetics during work-to-work transitions reflect a shift in the balance from rapid parasympathetic withdrawal to slower sympathetic activation of HR and cardiac output (25, 26). It was argued that slower cardiac output kinetics could limit O₂ delivery to contracting muscles, thereby restricting the rate at which $\dot{V}O_2$ rises to meet the increase in metabolic demand (25, 26). MacPhee et al. (40) provided support for this suggestion by showing that slower phase II $\dot{V}O_2$ kinetics were associated with

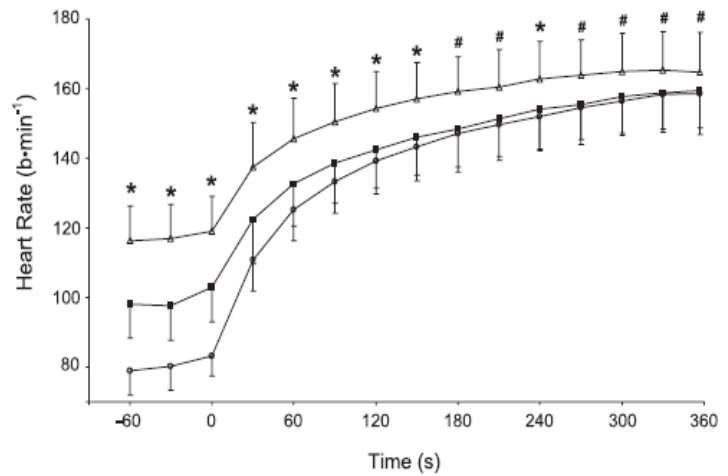

Fig. 2. Heart rate response at 30-s intervals during baseline cycling and severe exercise. ○, U→S condition; ■, M→S Unprimed condition; △, M→S Primed condition. Values are means ± SE. *Significant difference between all three conditions ($P < 0.05$); #significant difference between M→S Primed and the other two conditions ($P < 0.05$).

slower leg blood flow kinetics when moderate-intensity, knee-extension exercise was initiated from an elevated baseline metabolic rate. However, the leg blood flow kinetics in that study (mean τ of 39 s) were still appreciably faster than the phase II V_{O₂} kinetics (mean τ of 52 s), which would not be expected if bulk O₂ delivery kinetics were limiting muscle V_{O₂}. It should be noted, however, that conduit artery blood flow kinetics might not accurately reflect blood flow kinetics in the muscle microvasculature (18). An alternative proposition is that the slower phase II V_{O₂} kinetics during work-to-work exercise reflect the fact that such transitions functionally isolate the oxidative metabolic properties of the population of muscle fibers recruited to meet the increased energetic demand (5, 31, 61, 62).

In the present study, we used priming exercise to investigate the O₂ dependency of the strikingly slower V_{O₂} kinetics observed during work-to-work transitions. Priming exercise (particularly when of high-intensity and resulting in a metabolic acidosis) would be predicted to result in muscle vasodilatation and a right shift of the oxyhemoglobin dissociation curve and thus to increase both convective and diffusive components of muscle O₂ delivery (21). Indeed, priming exercise has been shown to increase cardiac output,

muscle blood flow, and muscle oxygenation before and during subsequent exercise (6, 14, 19, 31, 35, 63). That similar effects are likely to have occurred in the present study is evidenced by the significantly higher HR recorded both at baseline and throughout exercise, and the significantly elevated baseline blood [lactate] in the M→S Primed compared with the M→S Unprimed condition.

Despite the likelihood that muscle O₂ availability was enhanced, however, and in contrast to our hypothesis, the phase II τ was not altered by priming exercise (M→S Unprimed, 42 ± 15 s; M→S Primed, 42 ± 17 s). We, therefore, conclude that the slower V_{O₂} kinetics observed when high-intensity exercise is initiated from an elevated baseline metabolic rate are not mechanically linked to a muscle O₂ delivery insufficiency. The lack of an effect of priming exercise on the phase II τ during the moderate-to-severe exercise transition reported herein is consistent with the majority of previous studies that have focused on the effect of priming exercise on V_{O₂} kinetics during transitions from unloaded pedaling to heavy- or severe-intensity upright cycle exercise in healthy young subjects (e.g., Refs. 6–9, 17, 19, 27, 32, 34, 43, 53, 55, 63). However, when muscle O₂ delivery is compromised in the control condition and relatively slow phase II V_{O₂} kinetics are present, such as

Table 2. V_{O₂} kinetics during U→S, M→S Unprimed, and M→S Primed

	U→S	M→S Unprimed	M→S Primed
Baseline V _{O₂} , l/min	0.92±0.08	1.52±0.23*	1.65±0.18*†
Phase II τ , s	33±8	42±15*	42±17*
Phase II time delay, s	8±4	6±7	4±7
Phase II amplitude, l/min	2.07±0.28	1.61±0.25*	1.66±0.28*
Phase II gain, ml·min ⁻¹ ·W ⁻¹	8.4±0.7	9.3±1.4	9.5±1.4*
Phase II absolute amplitude, l/min	2.99±0.29	3.12±0.36	3.31±0.32*†
V _{O₂} slow-component time delay, s	107±38	116±45	122±30
V _{O₂} slow-component amplitude, l/min	0.62±0.20	0.47±0.09*	0.27±0.13*†
V _{O₂} slow-component relative amplitude, %	23±7	23±5	15±9*†
End-exercise V _{O₂} , l/min	3.58±0.26	3.59±0.33	3.57±0.23
End-exercise gain, ml·min ⁻¹ ·W ⁻¹	10.9±1.1	12.0±1.6*	11.1±1.3†
Mean response time, s	69±15	80±24*	63±18†
O ₂ deficit, liters	3.03±0.68	2.77±0.96	2.01±0.62*†
Relative O ₂ deficit, l/W	0.013±0.004	0.016±0.007*	0.012±0.004†

Values are means ± SD. V_{O₂}, O₂ uptake. *Significantly different from U→S condition ($P < 0.05$). †Significantly different from M→S Unprimed condition ($P < 0.05$).

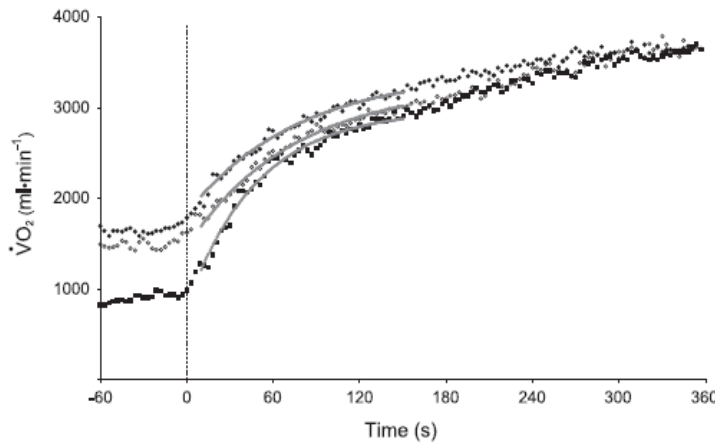

Fig. 3. Pulmonary O₂ uptake (\dot{V}_{O_2}) response following the onset of severe exercise in a representative subject. ■, U→S condition; ○, M→S Unprimed condition; ●, M→S Primed condition. Vertical dotted line represents the abrupt transition to the higher work rate. Note that the phase II \dot{V}_{O_2} kinetics are markedly slower when the transition is initiated from a higher baseline metabolic rate without priming. After priming, there is no change in the phase II time constant, but the overall \dot{V}_{O_2} response is faster due to an elevation in phase II absolute amplitude and a reduction in the amplitude of the \dot{V}_{O_2} slow component. See text for further details.

during heavy cycle exercise in the supine position (27), and during heavy arm crank exercise performed above the level of the heart (33), priming exercise has been shown to reduce the phase II τ . That this effect did not occur in the present study, therefore, indicates that the slow phase II \dot{V}_{O_2} kinetics observed in the M→S Unprimed condition were not related to an O₂ delivery limitation.

MacPhee et al. (40) reported slower HR kinetics when a transition to moderate-intensity knee extension exercise was initiated from an elevated baseline. In contrast, we observed no lengthening of the HR τ for M→S Unprimed compared with U→S, despite a significant elevation of baseline HR (Fig. 2). Wilkerson and Jones (61) also reported an invariant HR τ for transitions to severe-intensity cycle exercise from light, moderate, and heavy baselines. The explanation for the different findings is unclear, but is probably related to differences in both the exercise modality and particularly the range of exercise intensities investigated (transitions to severe-intensity exercise would be predominantly sympathetically driven, regardless of baseline metabolic rate). It is of interest, however, that the slower phase II \dot{V}_{O_2} kinetics observed for M→S Unprimed

compared with U→S in the present study occurred in the absence of an associated slowing of HR kinetics.

Our data are consistent with the suggestion that slower \dot{V}_{O_2} kinetics during work-to-work transitions are related to factors within the contracting muscle, such as the metabolic properties of the population of muscle fibers recruited across the transient (31). According to Henneman's size principle (24), only a fraction of the population of motor units typically required for a given work rate will be recruited when the transition is made from an elevated baseline metabolic rate, and that fraction will reside at the higher end of the recruitment hierarchy. These higher order fibers will typically possess a lower oxidative capacity, a reduced microvascular pressure head for O₂, slower \dot{V}_{O_2} kinetics, higher total creatine content, a greater propensity for "anaerobic" metabolism, a reduced efficiency, and greater fatigability, compared with fibers positioned lower in the recruitment hierarchy (4, 12, 50, 64). Interestingly, in addition to the slower \dot{V}_{O_2} kinetics, the end-exercise gain (which reflects muscle efficiency) and the O₂ deficit incurred relative to the change in work rate (which provides an indication of the relative contribution of O₂-independent metabolism to energy

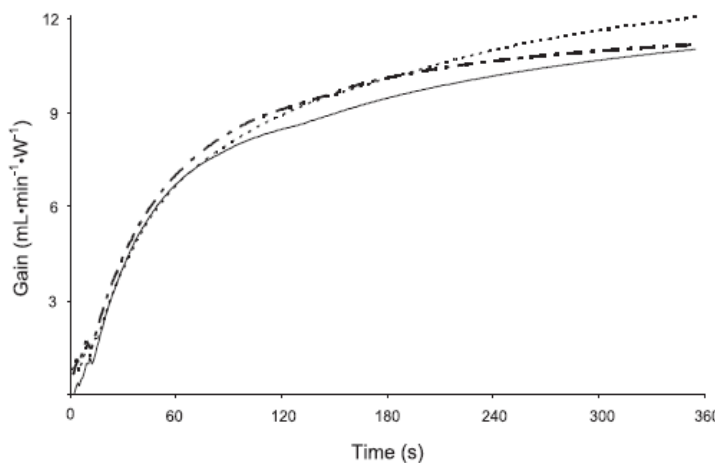

Fig. 4. Group mean \dot{V}_{O_2} response following the onset of severe exercise, where \dot{V}_{O_2} is expressed per unit change in work rate (i.e., gain). The solid line represents the U→S condition; the short-dashed line represents the M→S Unprimed condition; and the long-dashed line represents the M→S Primed condition. Note that the elevation in end-exercise gain that is present when severe-intensity exercise is initiated from a moderate-intensity baseline is reduced after priming.

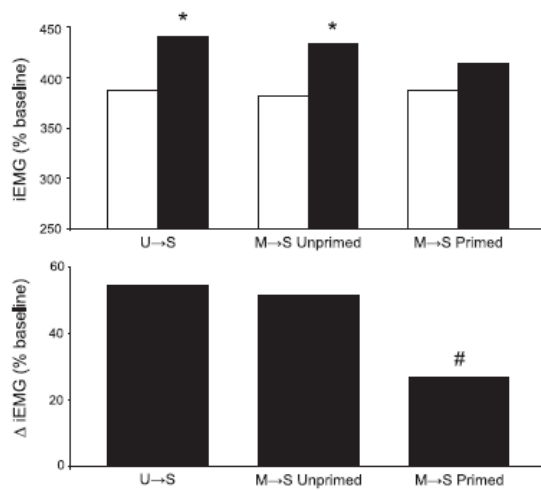

Fig. 5. Group mean integrated electromyogram (iEMG) response during severe exercise. *Top*: percentage of baseline iEMG measured at *minute 2* (open bars) and *minute 6* (solid bars) for each of the three conditions. *Significant difference between *minute 2* and *minute 6* within condition ($P < 0.05$). *Bottom*: change in iEMG (Δ iEMG) between 2 and 6 min for each of the three conditions. #Significant difference between M→S Primed and the other two conditions ($P < 0.05$). Error bars were excluded for clarity.

transfer) were both significantly greater for M→S Unprimed than for U→S. These results are similar to previous reports (5, 40, 61, 62) and are also suggestive of an amplified expression of the response characteristics of higher order muscle fibers during work-to-work transitions.

The MRT was significantly greater in M→S Unprimed compared with U→S, but priming reduced the MRT such that there was no significant difference between M→S Primed and U→S. This occurred primarily as a consequence of a reduction in the amplitude of the $\dot{V}O_2$ slow component (consistent with our hypothesis), although the absolute amplitude of the fundamental component of the $\dot{V}O_2$ response was also increased by priming. A reduction in the amplitude of the $\dot{V}O_2$ slow component is a consistent finding in studies that have investigated the influence of priming exercise on $\dot{V}O_2$ kinetics during subsequent high-intensity exercise (3, 6–9, 17, 19, 21, 27, 32, 34, 39, 51, 55, 63). Precisely why this occurs is unclear, but potential mechanisms include an increased homogeneity of local muscle perfusion relative to metabolic rate, improved muscle carbon substrate availability, and alterations in motor unit recruitment profiles: mechanisms that might not be mutually exclusive (29).

In the present study, the reduction in the $\dot{V}O_2$ slow component coincided with a significant reduction in Δ iEMG₆₋₂, suggesting that the smaller slow component might have been mechanistically linked to reduced neuromuscular activity. Indeed, during both the U→S and the M→S Unprimed conditions, the iEMG increased significantly between 2 and 6 min of exercise, whereas, in the M→S Primed condition, iEMG did not change significantly over this same time frame. Our results suggesting an association between neuromuscular activation and the $\dot{V}O_2$ slow component are consistent with some previous studies (6, 41, 42), but not others (11, 20, 55). Given the

variability associated with measurement of iEMG, it is perhaps unsurprising that inconsistent results have been reported. Even in our study, the reduction in the amplitude of the $\dot{V}O_2$ slow component with priming was not significantly correlated with the Δ iEMG₆₋₂ ($r = 0.28$). However, other evidence indicates that the $\dot{V}O_2$ slow component is linked to increased motor unit recruitment. For example, the transverse relaxation time of muscle protons from magnetic resonance images (T2, believed to represent muscle fiber recruitment) increases in a number of thigh muscles during high-intensity exercise and appears to be temporally associated with the $\dot{V}O_2$ slow component (16, 54). Moreover, Krstrup et al. (37) reported that both type I and type II fibers were recruited from close to the onset of severe-intensity exercise and that the development of the $\dot{V}O_2$ slow component was associated with the continued recruitment of both fiber types.

While it appears reasonable to assume that the $\dot{V}O_2$ slow component is associated in some way with the recruitment of higher order (perhaps type II) fibers with poor efficiency (2, 6, 16, 36, 37, 44, 48, 49, 52, 53), it is presently unclear whether the association derives from a progressive recruitment of higher-order fibers as exercise proceeds, from the slow kinetics and/or the effects of fatigue on these fibers if they are recruited near the onset of exercise, or through a combination of these processes (44, 61). The reduction in the $\dot{V}O_2$ slow component following priming exercise in the present study might, therefore, have occurred through a number of potential mechanisms. One possibility is that priming exercise resulted in the activation of more motor units at subsequent exercise onset, thereby decreasing the need to recruit additional motor units (and the O₂ cost associated with that activation) as exercise proceeded (6, 37). However, unlike in the study of Burnley et al. (6), the iEMG at 2 min of exercise was not significantly increased by priming exercise in the present study (Fig. 5). Another possibility is that greater and/or more homogenous muscle O₂ delivery reduced the rate of fatigue development and thus the extent of additional motor unit recruitment required to maintain force production, again with a consequent reduction in the O₂ cost of exercise (44). Finally, if the $\dot{V}O_2$ slow component reflects, at least in part, the slower $\dot{V}O_2$ kinetics of high-order fibers recruited at exercise onset (61), then priming exercise might have speeded $\dot{V}O_2$ kinetics in these fibers such that they reached their individual “steady-state” values more rapidly. However, if this latter effect did occur, then it was insufficient to impact measurably on the phase II τ .

In conclusion, the most important finding in this investigation was that significantly slower phase II $\dot{V}O_2$ kinetics observed when severe-intensity exercise was initiated from an elevated baseline metabolic rate were not altered when the transient was preceded by a bout of high-intensity priming exercise. However, the amplitude of the $\dot{V}O_2$ slow component and the Δ iEMG₆₋₂ of exercise were significantly reduced following priming exercise. These results suggest that the slower phase II $\dot{V}O_2$ kinetics evident during moderate-to-severe exercise transitions are not related to an O₂ delivery limitation across the transient, but are rather linked to intramuscular factors, such as the metabolic properties of the population of muscle fibers recruited.

REFERENCES

- Barstow TJ, Lamarra N, Whipp BJ. Modulation of muscle and pulmonary O₂ uptakes by circulatory dynamics during exercise. *J Appl Physiol* 68: 979–989, 1990.
- Barstow TJ, Jones AM, Nguyen H, Casaburi R. Influence of muscle fiber type and pedal frequency on oxygen uptake kinetics of heavy exercise. *J Appl Physiol* 81: 1642–1650, 1996.
- Bearden SE, Moffatt RJ. V_{O₂} and heart rate kinetics in cycling: transitions from an elevated baseline. *J Appl Physiol* 90: 2081–2087, 2001.
- Behnke BJ, McDonough P, Padilla DJ, Musch TI, Poole DC. Oxygen exchange profile in rat muscles of contrasting fibre types. *J Physiol* 549: 597–605, 2003.
- Brittain CJ, Rossiter HB, Kowalchuk JM, Whipp BJ. Effect of prior metabolic rate on the kinetics of oxygen uptake during moderate-intensity exercise. *Eur J Appl Physiol* 86: 125–134, 2001.
- Burnley M, Doust JH, Ball D, Jones AM. Effects of prior heavy exercise on V_{O₂} kinetics during heavy exercise are related to changes in muscle activity. *J Appl Physiol* 93: 167–174, 2002.
- Burnley M, Doust JH, Carter H, Jones AM. Effects of prior exercise and recovery duration on oxygen uptake kinetics during heavy exercise in humans. *Exp Physiol* 86: 417–425, 2001.
- Burnley M, Doust JH, Jones AM. Time required for the restoration of normal heavy exercise V_{O₂} kinetics following prior heavy exercise. *J Appl Physiol* 101: 1320–1327, 2006.
- Burnley M, Jones AM, Carter H, Doust JH. Effects of prior heavy exercise on phase II pulmonary oxygen uptake kinetics during heavy exercise. *J Appl Physiol* 89: 1387–1396, 2000.
- Burnley M, Koppo K, Jones AM. “Priming exercise” and V_{O₂} kinetics. In: *Oxygen Uptake Kinetics in Sport, Exercise and Medicine*, edited by Jones AM and Poole DC. London: Routledge, 2005, p. 230–260.
- Cannon DT, Kolkhorst FW, Cipriani DJ. Electromyographic data do not support a progressive recruitment of muscle fibers during exercise exhibiting a V_{O₂} slow component. *J Physiol Anthropol* 26: 541–546, 2007.
- Crow MT, Kushmerick MJ. Chemical energetics of slow- and fast-twitch muscles of the mouse. *J Gen Physiol* 79: 147–166, 1982.
- DeLorey DS, Kowalchuk JM, Heenan AP, Dumanoir GR, Paterson DH. Prior exercise speeds pulmonary O₂ uptake kinetics by increases in both local muscle O₂ availability and O₂ utilization. *J Appl Physiol* 103: 771–778, 2007.
- DeLorey DS, Kowalchuk JM, Paterson DH. Effects of prior heavy-intensity exercise on pulmonary O₂ uptake and muscle deoxygenation kinetics in young and older adult humans. *J Appl Physiol* 97: 998–1005, 2004.
- di Prampero PE, Mahler PB, Giezendanner D, Cerretelli P. Effects of priming exercise on V_{O₂} kinetics and O₂ deficit at the onset of stepping and cycling. *J Appl Physiol* 66: 2023–2031, 1989.
- Endo M, Kobayakawa M, Kinugasa R, Kuno S, Akima H, Rossiter H, Miura A, Fukuba Y. High muscle activation distribution and pulmonary V_{O₂} kinetics during moderate, heavy, and very heavy intensity cycling exercise in humans. *Am J Physiol Regul Integr Comp Physiol* 293: R812–R820, 2007.
- Endo M, Okada Y, Rossiter HB, Ooue A, Miura A, Koga S, Fukuba Y. Kinetics of pulmonary V_{O₂} and femoral artery blood flow and their relationship during repeated bouts of heavy exercise. *Eur J Appl Physiol* 95: 418–430, 2005.
- Ferreira LF, Koga S, Barstow TJ. Dynamics of noninvasively estimated microvascular O₂ extraction during ramp exercise. *J Appl Physiol* 103: 1999–2004, 2007.
- Fukuba Y, Hayashi N, Koga S, Yoshida T. V_{O₂} kinetics in heavy exercise is not altered by prior exercise with a different muscle group. *J Appl Physiol* 92: 2467–2474, 2002.
- Garland SW, Wang W, Ward SA. Indices of electromyographic activity and the “slow” component of oxygen uptake kinetics during high-intensity knee-extension exercise in humans. *Eur J Appl Physiol* 97: 413–423, 2006.
- Gerbino A, Ward SA, Whipp BJ. Effects of prior exercise on pulmonary gas-exchange kinetics during high-intensity exercise in humans. *J Appl Physiol* 80: 99–107, 1996.
- Grassi B, Poole DC, Richardson RS, Knight DR, Erickson BK, Wagner PD. Muscle O₂ uptake kinetics in humans: implications for metabolic control. *J Appl Physiol* 80: 988–998, 1996.
- Gurd BJ, Scheuermann BW, Paterson DH, Kowalchuk JM. Prior heavy-intensity exercise speeds V_{O₂} kinetics during moderate-intensity exercise in young adults. *J Appl Physiol* 98: 1371–1378, 2005.
- Henneman E, Mendell LM. Functional organization of motoneuron pool and its inputs. In: *Handbook of Physiology. The Nervous System. Motor Control*. Bethesda, MD: Am. Physiol. Soc., 1981, sect. 1, vol. II, pt. 1, chapt. 11, p. 423–507.
- Hughson RL, Morrissey M. Delayed kinetics of respiratory gas exchange in the transition from prior exercise. *J Appl Physiol* 52: 921–929, 1982.
- Hughson RL, Morrissey M. Delayed kinetics of V_{O₂} in the transition from prior exercise. Evidence for O₂ transport limitation of V_{O₂} kinetics: a review. *Int J Sports Med* 4: 31–39, 1983.
- Jones AM, Berger NJ, Wilkerson DP, Roberts CL. Effects of “priming” exercise on pulmonary O₂ uptake and muscle deoxygenation kinetics during heavy-intensity cycle exercise in the supine and upright positions. *J Appl Physiol* 101: 1432–1441, 2006.
- Jones AM, Koppo K, Burnley M. Effects of prior exercise on metabolic and gas exchange responses to exercise. *Sports Med* 33: 949–971, 2003.
- Jones AM, Poole DC. Oxygen uptake dynamics: from muscle to mouth—an introduction to the symposium. *Med Sci Sports Exerc* 37: 1542–1550, 2005.
- Jones AM, Wilkerson DP, Fulford J. Muscle [PCr] dynamics following the onset of exercise in humans: the influence of baseline work-rate. *J Physiol* 586: 889–898, 2008.
- Jones AM, Fulford J, Wilkerson DP. Influence of prior exercise on muscle [phosphorylcreatine] and deoxygenation kinetics during high-intensity exercise in men. *Exp Physiol* 93: 468–478, 2008.
- Koppo K, Bouckaert J. The effect of prior high-intensity cycling exercise on the V_{O₂} kinetics during high-intensity cycling exercise is situated at the additional slow component. *Int J Sports Med* 22: 21–26, 2001.
- Koppo K, Bouckaert J. Prior arm exercise speeds the V_{O₂} kinetics during arm exercise above the heart level. *Med Sci Sports Exerc* 37: 613–619, 2005.
- Koppo K, Jones AM, Bouckaert J. Effect of prior heavy arm and leg exercise on V_{O₂} kinetics during heavy leg exercise. *Eur J Appl Physiol* 88: 593–600, 2003.
- Krustrup P, Gonzalez-Alonso J, Quistorff B, Bangsbo J. Muscle heat production and anaerobic energy turnover during repeated intense dynamic exercise in humans. *J Physiol* 536: 947–956, 2001.
- Krustrup P, Soderlund K, Mohr M, Bangsbo J. Slow-twitch fiber glycogen depletion elevates moderate-exercise fast-twitch fiber activity and O₂ uptake. *Med Sci Sports Exerc* 36: 973–982, 2004a.
- Krustrup P, Soderlund K, Mohr M, Bangsbo J. The slow component of oxygen uptake during intense, sub-maximal exercise in man is associated with additional fibre recruitment. *Pflügers Arch* 447: 855–866, 2004b.
- Lamarra N, Whipp BJ, Ward SA, Wasserman K. Effect of interbreath fluctuations on characterizing exercise gas exchange kinetics. *J Appl Physiol* 62: 2003–2012, 1987.
- MacDonald M, Pedersen PK, Hughson RL. Acceleration of V_{O₂} kinetics in heavy submaximal exercise by hyperoxia and prior high-intensity exercise. *J Appl Physiol* 83: 1318–25, 1997.
- MacPhee SL, Shoemaker JK, Paterson DH, Kowalchuk JM. Kinetics of O₂ uptake, leg blood flow and muscle deoxygenation are slowed in the upper compared with lower regions of the moderate-intensity exercise domain. *J Appl Physiol* 99: 1822–1834, 2005.
- Osborne MA, Schneider DA. Muscle glycogen reduction in man: relationship between surface EMG activity and oxygen uptake kinetics during heavy exercise. *Exp Physiol* 91: 179–189, 2006.
- Perrey S, Betik A, Candau R, Rouillon JD, Hughson RL. Comparison of oxygen uptake kinetics during concentric and eccentric cycle exercise. *J Appl Physiol* 91: 2135–2142, 2001.
- Perrey S, Scott J, Mouro L, Rouillon JD. Cardiovascular and oxygen uptake kinetics during sequential heavy cycling exercises. *Can J Appl Physiol* 28: 283–298, 2003.
- Poole DC, Jones AM. Towards an understanding of the mechanistic bases of V_{O₂} kinetics. In: *Oxygen Uptake Kinetics in Sport, Exercise and Medicine*, edited by Jones AM and Poole DC. London: Routledge, 2005, p. 298–328.
- Poole DC, Schaffartzik W, Knight DR, Derion T, Kennedy B, Guy HJ, Prediletto R, Wagner PD. Contribution of exercising legs to the slow component of oxygen uptake kinetics in humans. *J Appl Physiol* 71: 1245–1260, 1991.

46. Poole DC, Kindig CA, Behnke BJ. V_{O₂} kinetics in different disease states. In: *Oxygen Uptake Kinetics in Sport, Exercise and Medicine*, edited by Jones AM and Poole DC. London: Routledge, 2005, p. 353–372.
47. Poole DC, Wilkerson DP, Jones AM. Validity of criteria for establishing maximal O₂ uptake during ramp exercise tests. *Eur J Appl Physiol* 102: 403–410, 2008.
48. Pringle JS, Doust JH, Carter H, Tolfrey K, Campbell IT, Sakkas GK, Jones AM. Oxygen uptake kinetics during moderate, heavy and severe intensity “submaximal” exercise in humans: the influence of muscle fibre type and capillarisation. *Eur J Appl Physiol* 89: 289–300, 2003.
49. Pringle JS, Doust JH, Carter H, Tolfrey K, Jones AM. Effect of pedal rate on primary and slow-component oxygen uptake responses during heavy-cycle exercise. *J Appl Physiol* 94: 1501–1507, 2003.
50. Reggiani C, Potma EJ, Bottinelli R, Canepari M, Pellegrino MA, Stienen GJM. Chemo-mechanical energy transduction in relation to myosin isoform composition in skeletal muscle fibres of the rat. *J Physiol* 502: 449–460, 1997.
51. Rossiter HB, Ward SA, Kowalchuk JM, Howe FA, Griffiths JR, Whipp BJ. Effects of prior exercise on oxygen uptake and phosphocreatine kinetics during high-intensity knee-extension exercise in humans. *J Physiol* 537: 291–303, 2001.
52. Rossiter HB, Ward SA, Kowalchuk JM, Howe FA, Griffiths JR, Whipp BJ. Dynamic asymmetry of phosphocreatine concentration and O₂ uptake between the on- and off-transients of moderate- and high-intensity exercise in humans. *J Physiol* 541: 991–1002, 2002.
53. Sahlin K, Sørensen JB, Gladden LB, Rossiter HB, Pedersen PK. Prior heavy exercise eliminates V_{O₂} slow component and reduces efficiency during submaximal exercise in humans. *J Physiol* 564: 765–773, 2005.
54. Saunders MJ, Evans EM, Arngimsson SA, Allison JD, Cureton KJ. Endurance training reduces end-exercise V_{O₂} and muscle use during submaximal cycling. *Med Sci Sports Exerc* 35: 257–262, 2003.
55. Scheuermann BW, Hoelting BD, Noble ML, Barstow TJ. The slow component of O₂ uptake is not accompanied by changes in muscle EMG during repeated bouts of heavy exercise in humans. *J Physiol* 531: 245–256, 2001.
56. Whipp BJ. The slow component of O₂ uptake kinetics during heavy exercise. *Med Sci Sports Exerc* 26: 1319–1326, 1994.
57. Whipp BJ, Davis JA, Torres F, Wasserman K. A test to determine parameters of aerobic function during exercise. *J Appl Physiol* 50: 217–221, 1981.
58. Whipp BJ, Mahler M. Dynamics of gas exchange during exercise. In: *Pulmonary Gas Exchange*, edited by West JB. New York: Academic, 1980, vol. II, p. 33–96.
59. Whipp BJ, Rossiter H. The kinetics of oxygen uptake: physiological inferences from the parameters. In: *Oxygen Uptake Kinetics in Sport, Exercise and Medicine*, edited by Jones AM and Poole DC. London: Routledge, 2005, p. 62–94.
60. Whipp BJ, Ward SA, Lamarra N, Davis JA, Wasserman K. Parameters of ventilatory and gas exchange dynamics during exercise. *J Appl Physiol* 52: 1506–1513, 1982.
61. Wilkerson DP, Jones AM. Influence of initial metabolic rate on pulmonary O₂ uptake on-kinetics during severe intensity exercise. *Respir Physiol Neurobiol* 152: 204–219, 2006.
62. Wilkerson DP, Jones AM. Effects of baseline metabolic rate on pulmonary O₂ uptake on-kinetics during heavy-intensity exercise in humans. *Respir Physiol Neurobiol* 156: 203–211, 2007.
63. Wilkerson DP, Köppo K, Barstow TJ, Jones AM. Effect of prior multiple-sprint exercise on pulmonary O₂ uptake kinetics following the onset of perimaximal exercise. *J Appl Physiol* 97: 1227–1236, 2004.
64. Willis WT, Jackman MR. Mitochondrial function during heavy exercise. *Med Sci Sports Exerc* 26: 1347–1353, 1994.



Influence of priming exercise on muscle [PCr] and pulmonary O₂ uptake dynamics during “work-to-work” knee-extension exercise

Fred J. DiMenna,¹ Jonathan Fulford,² Stephen J. Bailey,¹ Anni Vanhatalo,¹ Daryl P. Wilkerson,¹ and Andrew M. Jones¹

¹School of Sport and Health Sciences and ²Peninsula NIHR Clinical Research Facility, University of Exeter, Exeter, Devon, EX1 2LU, United Kingdom

DiMenna FJ, Fulford J, Bailey SJ, Vanhatalo A, Wilkerson DP, Jones AM. Influence of priming exercise on muscle [PCr] and pulmonary O₂ uptake dynamics during ‘work-to-work’ knee-extension exercise – Metabolic transitions from rest to high-intensity exercise were divided into two discrete steps (i.e., rest-to-moderate-intensity (R→M) and moderate-to-high-intensity (M→H)) to explore the effect of prior high-intensity “priming” exercise on intramuscular [PCr] and pulmonary $\dot{V}O_2$ kinetics for different sections of the motor unit pool. It was hypothesized that [PCr] and $\dot{V}O_2$ kinetics would be unaffected by priming during R→M exercise, but that the time constants (τ) describing the fundamental [PCr] response and the phase II $\dot{V}O_2$ response would be significantly reduced by priming for M→H exercise. On three separate occasions, six male subjects completed two identical R→M/M→H “work-to-work” prone knee-extension exercise bouts separated by 5 min rest. Two trials were performed with measurement of pulmonary $\dot{V}O_2$ and the integrated electromyogram (iEMG) of the right *m. vastus lateralis*. The third trial was performed within the bore of a 1.5-T superconducting magnet for ³¹P-MRS assessment of muscle metabolic responses. Priming did not significantly affect the [PCr] or $\dot{V}O_2$ τ during R→M ([PCr] τ Unprimed: 24 ± 16 vs. Primed: 22 ± 14 s; $\dot{V}O_2$ τ Unprimed: 26 ± 8 vs. Primed: 25 ± 9 s) or M→H transitions ([PCr] τ Unprimed: 30 ± 5 vs. Primed: 32 ± 7 s; $\dot{V}O_2$ τ Unprimed: 37 ± 5 vs. Primed: 38 ± 9 s). However, it did reduce the amplitudes of the [PCr] and $\dot{V}O_2$ slow components by 50% and 46%, respectively, during M→H ($P < 0.05$ for both comparisons). These effects were accompanied by iEMG changes suggesting reduced muscle fiber activation during M→H exercise after priming. It is concluded that the τ for the initial exponential change of muscle [PCr] and pulmonary $\dot{V}O_2$ following the transition from moderate-to-high-intensity prone knee-extension exercise is not altered by priming exercise.

PCr dynamics; $\dot{V}O_2$ kinetics; knee-extension exercise; work-to-work transition; priming exercise.

THE PHYSIOLOGICAL FACTORS THAT RATE-LIMIT the increase in muscle and pulmonary O₂ uptake ($\dot{V}O_2$) following a step change in metabolic rate, such as at the onset of exercise, remain a source of debate (28, 43, 47, 63). Depending on the experimental paradigm, including the subject population and the type of exercise being performed, these factors are likely to involve feedback control of mitochondrial respiration through the creatine kinase (CK) reaction (23, 32, 35, 43, 46, 50), the activation of rate-limiting metabolic enzymes (18, 24, 47, 63), muscle fiber recruitment patterns (5, 6, 12, 27), and muscle O₂ availability (28, 29, 42, 48, 63). Faster $\dot{V}O_2$ kinetics will

limit the magnitude of the O₂ deficit and thus the contribution of substrate-level phosphorylation to energy metabolism and the muscle metabolic perturbation experienced across the transition from a lower to a higher metabolic rate (47, 58). As such, resolution of the factors limiting $\dot{V}O_2$ kinetics is important as a first step towards the design of physical or pharmacological interventions to enhance human exercise tolerance.

Prior exercise models have been used extensively to investigate the control of respiration following the onset of exercise. Such “priming” exercise increases convective and diffusive components of muscle O₂ delivery, increases the activity of rate-limiting enzymes in the respiratory chain, alters motor unit recruitment patterns, and can profoundly influence the $\dot{V}O_2$ response during subsequent exercise (31). However, whether and how priming alters $\dot{V}O_2$ kinetics depends upon a number of factors including the age and training status of the subjects, the exercise modality and body position, and the intensity of the priming and criterion exercise bouts (2, 8, 13, 24, 29, 37). For example, moderate-intensity exercise (i.e., below the lactate threshold, <LT) is generally unaffected by priming (9, 19, 22) whereas high-intensity exercise (>LT) is characterized by an accelerated overall $\dot{V}O_2$ response (8, 9, 22). The majority of previous studies indicate that this speeding is usually due to a reduction of the $\dot{V}O_2$ slow component amplitude with unchanged phase II $\dot{V}O_2$ time constant (τ_p) (2, 7-9, 21, 36, 62). However, in circumstances where the τ_p is relatively long in the control condition, such as during supine cycling where the exercising musculature is at or above the level of the heart, priming shortens τ_p , but does not affect the response-phase amplitudes (29, 37).

By dividing metabolic transitions to high-intensity exercise into two discrete steps (e.g., rest-to-moderate-intensity transition and moderate-to-high-intensity transition; i.e., R→M and M→H, respectively), the response characteristics of different segments of the motor unit recruitment pool can be isolated (16, 17, 34, 60, 61). For example, compared to R→M (or, more properly, unloaded to moderate-intensity cycling), the M→H (i.e., “work-to-work”) transition during upright cycle exercise is characterized by a lengthened τ_p and a greater $\dot{V}O_2$ increase per work rate increment ($\Delta\dot{V}O_2/\Delta\text{work rate}$; G), (16, 17, 61). This response is consistent with a greater proportional involvement of muscle fibers that are positioned higher in the recruitment hierarchy (e.g., type II fibers) under these circumstances (27, 39, 61); type II fibers are generally accepted to possess slower $\dot{V}O_2$ kinetics and poor efficiency relative to type I fibers (12, 49).

To our knowledge, only two studies have examined the effect of priming exercise on $\dot{V}O_2$ kinetics during work-to-work exercise. During upright cycle exercise, DiMenna et al. (14) reported that priming did not alter τ_p ,

 $\dot{V}O_2$ AND [PCr] DYNAMICS AFTER PRIMING

but did reduce the amplitude of the $\dot{V}O_2$ slow component in M→H transitions. In contrast, during supine cycle exercise, priming significantly reduced the τ_p during M→H exercise without altering the response-phase amplitudes (17). These data were interpreted to indicate that, during upright cycling, the longer τ_p during M→H compared to R→M was related to innately slower $\dot{V}O_2$ kinetics of the higher-order fibers recruited in the work-to-work transition whereas during supine cycling, the reduced perfusion pressure resulted in the superimposition of an O₂-delivery limitation during M→H that was “corrected” by priming exercise.

The kinetic features of the intramuscular [PCr] response to exercise are similar to those of pulmonary $\dot{V}O_2$ (4, 44, 50-53). This association is consistent with the view that oxidative phosphorylation is principally under feedback control through one or more of the reactants or products of cytosolic high-energy phosphate hydrolysis (23, 43, 46). Accordingly, similar to what has been reported for $\dot{V}O_2$, the fundamental [PCr] τ has been shown to be markedly lengthened and the fall in [PCr] for a given increase in work rate to be greater for M→H compared to R→M transitions (34). The influence of priming exercise on muscle [PCr] kinetics during full rest-to-high-intensity exercise transitions has been examined previously (20, 30, 41, 51). These studies have consistently shown that priming does not alter the τ for the fundamental [PCr] response, but does reduce the amplitude of the subsequent [PCr] slow component. Rossiter et al. (51) measured [PCr] and $\dot{V}O_2$ kinetics simultaneously and reported that priming resulted in a reduction of the τ_p for $\dot{V}O_2$, but not [PCr], during subsequent high-intensity prone knee-extension exercise, suggesting a dissociation between the $\dot{V}O_2$ and [PCr] dynamics in the “primed” condition. No previous studies have investigated the influence of priming on muscle [PCr] kinetics during R→M or M→H work-to-work transitions.

The purpose of the present study was to investigate the influence of priming on the [PCr] and $\dot{V}O_2$ responses of different segments of the motor unit recruitment pool during prone knee-extension exercise by dividing high-intensity transitions into R→M and M→H steps. This would be expected to provide insight into whether the slower [PCr] and $\dot{V}O_2$ responses during M→H compared to R→M transitions are related only to the intrinsic metabolic properties of the different populations of muscle fibers contributing to power production, or whether the kinetics are additionally limited by muscle O₂ delivery. We hypothesized that the performance of prior high-intensity exercise: 1) would not influence [PCr] or $\dot{V}O_2$ kinetics during R→M transitions; but 2) would reduce the fundamental phase [PCr] τ and $\dot{V}O_2$ τ_p without altering response-phase amplitudes during M→H transitions.

METHODS

Subjects. Six male subjects (mean \pm SD age 33 \pm 10 years, stature 1.82 \pm 0.04 m, mass 79.5 \pm 7.7 kg) volunteered and gave written informed consent to participate in this study, which had been approved by the local Research Ethics Committee. The subjects were all recreationally active in a variety of sport and exercise activities and were non-smokers. On test days, subjects

were instructed to report to the laboratory in a rested state, having completed no strenuous exercise within the previous 24 hours, and having abstained from food, alcohol and caffeine for the preceding 3 hours.

Experimental Overview. This study required subjects to perform four double-legged knee-extension exercise tests. Initially, a preliminary incremental test that served to familiarise subjects with the exercise modality and also provided data that helped to determine moderate- and high-intensity work rates for each subject was performed. Subsequently, the subjects completed two identical “work-to-work” exercise tests separated by five minutes of rest on three separate occasions. All testing was completed in an air-conditioned environment at a temperature of 20-22°C and was conducted at the same time of day (\pm 2 h) for each subject. Two of these tests were performed in the exercise physiology laboratory and the third was performed in the MRS laboratory at the Peninsula Magnetic Resonance Research Centre (Exeter, UK). The three tests were undertaken in random order and the same ergometer and procedures were used for all testing. The double-legged knee-extension exercise tests were conducted in the prone position, with subjects secured to the ergometer bed via Velcro straps at the thigh, buttocks, lower back and middle back to minimize extraneous movement during exercise. The custom-designed ergometer consisted of a nylon frame that was fitted onto the bed in alignment with the subject’s feet and a base unit that was positioned behind the bed. Cuffs with Velcro straps were secured to the subject’s feet and ropes were attached to the cuffs. These ropes passed around pulleys housed within the frame to points of attachment on chains that meshed with a cassette of sprockets on the base unit. The sprocket arrangement was such that when a bucket containing non-magnetic weights was attached to each chain, it provided a concentric-only resistive load for each leg. This allowed for the performance of rhythmic double-legged knee-extension exercise in a contralateral-alternating manner over a distance of ~0.22 m. Subjects lifted the weight in accordance with a visual cue at a frequency of 40 rpm.

Exercise Physiology Laboratory Testing. On the first visit to the exercise physiology laboratory, subjects performed an incremental exercise test to volitional exhaustion. This test involved two-minute stages with the load progressed according to subject perceived exertion. This allowed for the completion of six stages (12 minutes of exercise) in all cases and provided the opportunity for subjects to become accustomed to this novel form of exercise. Bipolar surface electromyography was used to measure neuromuscular activity of the *m. vastus lateralis* of the right leg throughout these incremental tests. This provided data that was subsequently used to determine appropriate resistive loads to comprise the work-to-work exercise bouts. For electromyographic measurements, the leg was initially shaved and cleaned with alcohol around the belly of the muscle and graphite snap electrodes (Unilect 40713, Unomedical, Stonehouse, Great Britain) were adhered to the prepared area in a bipolar arrangement (interelectrode distance 40 mm). A ground electrode was positioned on the biceps femoris equidistant from the active electrodes. The sites of electrode placement were chosen according to the recommendations provided in the EMG software (Mega Electronics Ltd, Finland). To secure electrodes and wires in place and to minimize movement during knee-extension exercise, an elastic bandage was wrapped around the subject’s leg. Pen

$\dot{V}O_2$ AND [PCR] DYNAMICS AFTER PRIMING

marks were made around the electrodes to enable reproduction of the placement in subsequent tests. The EMG signal was recorded at a sampling frequency of 1000 Hz using a ME3000PB Muscle Tester (Mega Electronics Ltd, Finland). The bipolar signal was amplified (amplifier input impedance > 1 M Ω), and data were collected on-line in raw form and stored on a personal computer using MegaWin software (Mega Electronics Ltd, Finland). The raw EMG data were subsequently exported as an ASCII file and analyzed at a later date (see below). Subjects initially performed three maximal voluntary contractions (MVC) with the right leg flexed at ~30 degrees. Each contraction was maintained for 3 s and a 60-s rest period was provided between repeat trials. Five minutes of passive rest separated the final MVC from the beginning of the incremental bout.

On the next two visits to the exercise physiology laboratory, subjects performed the experimental protocol with pulmonary gas exchange and ventilation measured breath-by-breath and EMG measured as outlined above. The protocol involved three MVCs (see above), 5 min of passive rest, 6 min of moderate-intensity knee-extension exercise, 6 min of high-intensity knee-extension exercise, 5 min of passive rest, 6 min of moderate-intensity knee-extension exercise and 6 min of high-intensity knee-extension exercise. This provided data for moderate unprimed (R→M Unprimed), work-to-work unprimed (M→H Unprimed), moderate primed (R→M Primed), and work-to-work primed (M→H Primed) exercise transitions.

Pulmonary gas exchange and ventilation were measured breath-by-breath with subjects wearing a nose clip and breathing through a low-dead-space, low-resistance mouthpiece and bidirectional digital volume sensor (Jaeger TripleV). The inspired and expired gas volume and gas concentration signals were continuously sampled at 100 Hz via a capillary line connected to the mouthpiece, the latter using paramagnetic (O₂) and infrared (CO₂) analyzers (Jaeger Oxycon Pro, Hoechberg, Germany). The gas analyzers were calibrated before each test with gases of known concentration and the volume sensor was calibrated using a 3-liter syringe (Hans Rudolph, Kansas City, MO). During one of the two trials, a blood sample from a fingertip was collected into a capillary tube over the 20 s preceding any step transition in work rate and within the last 20 s of exercise and subsequently analyzed to determine blood [lactate] (YSI 1500, Yellow Springs Instruments, Yellow Springs, OH, United States). Blood lactate accumulation (Δ blood [lactate]) was calculated as the difference between blood [lactate] at end-exercise and blood [lactate] prior to the transition. The $\dot{V}O_2$ responses from like-transitions were averaged prior to any analysis being performed in order to enhance the signal-to-noise ratio and improve confidence in the parameters derived from the model fits (40, 58). The EMG data from like transitions were also averaged prior to further analysis.

MRS Laboratory Testing. During the visit to the MRS laboratory, the same experimental protocol outlined above including the initial MVC procedure was performed; however, in this case, subjects were positioned prone inside the bore of a 1.5-T superconducting MR scanner for ³¹P-MRS assessment of muscle metabolic responses. A 6-cm ³¹P transmit/receive surface coil was placed within the subject bed and the subject was asked to lie on it such that the coil was centered over the quadriceps muscle of the right leg. Cod liver oil capsules that yield

high-intensity signal points within the image were placed adjacent to the coil and fast field echo images were acquired to ensure that the muscle was positioned correctly. A number of pre-acquisition steps were carried out to optimize the signal from the muscle. Tuning and matching of the coil were performed to maximize energy transfer between the coil and the muscle followed by an automatic shimming protocol undertaken within a volume that defines the quadriceps muscle to optimize the homogeneity of the local magnetic field. Finally, to ensure a consistent distance from the coil at the time of data sampling, ³¹P-MRS examination of the quadriceps was synchronized with end-range extension. Before and during exercise, following the application of an adiabatic excitation pulse every 1.5 s, data were acquired with a spectral width of 1,500 Hz and 1000 data points. Phase cycling with four phase cycles was employed, which lead to a spectrum being acquired every 6 s. The subsequent spectra were quantified via peak fitting, with the assumption of prior knowledge, using the jMRUI (version 2) software package and the AMARES fitting algorithm (57). Spectra were fitted according to the assumption that Pi, PCr, α -ATP (two peaks, amplitude ratio 1:1), γ -ATP (two peaks, amplitude ratio 1:1), β -ATP (three peaks, amplitude ratio 1:2:1) and phosphodiester peaks were present. In all cases, relative amplitudes were corrected for partial saturation due to the repetition time relative to T1 via an unsaturated spectra acquired prior to the exercise protocol. Intracellular pH was calculated using the chemical shift of the Pi spectral peak relative to the PCr peak (56). Baseline and end-exercise intramuscular pH were defined as the mean intramuscular pH measured over the final 30 s prior to each transition and the final 30 s of exercise, respectively. Intramuscular pH during exercise was calculated as the mean of the values measured immediately prior to and after each minute-by-minute time point (i.e., a 6-s bin centered on 60, 120, 180, 240 and 300 s).

Data Analysis Procedures. The breath-by-breath $\dot{V}O_2$ data from each test were initially examined to exclude errant breaths caused by coughing, swallowing, sighing, etc., and those values lying more than four standard deviations from the local mean were removed. The breath-by-breath data were subsequently linearly interpolated to provide second-by-second values and, for each individual, identical repetitions were time-aligned to the start of exercise and ensemble-averaged. To further reduce breath-to-breath noise and enhance underlying response characteristics, each averaged response was then smoothed with a five-point rolling-average filter before a nonlinear least-square algorithm was used to fit the data. The inflection point that separates the cardiodynamic and phase II response phases was identified by visual inspection and the fitting window was constrained to start at that time point (59). For moderate- and high-intensity exercise, a single- (equation 1) and bi- (equation 2) exponential model, respectively, were used to characterize the $\dot{V}O_2$ response, as described in the following equations:

$$\dot{V}O_2(t) = \dot{V}O_{2 \text{ baseline}} + A_p(1 - e^{-(t-TD_p)/\tau_p}) \quad (\text{Eqn 1})$$

$$\dot{V}O_2(t) = \dot{V}O_{2 \text{ baseline}} + A_p(1 - e^{-(t-TD_p)/\tau_p}) + A_s(1 - e^{-(t-TD_s)/\tau_s}) \quad (\text{Eqn 2})$$

where $\dot{V}O_2(t)$ represents the absolute $\dot{V}O_2$ at a given time t ; $\dot{V}O_{2 \text{ baseline}}$ represents the mean $\dot{V}O_2$ in the baseline

$\dot{V}O_2$ AND [PCr] DYNAMICS AFTER PRIMING

period; A_p , TD_p , and τ_p represent the amplitude, time delay, and time constant, respectively, describing the phase II increase in $\dot{V}O_2$ above baseline; and A_s , TD_s , and τ_s represent the amplitude of, time delay before the onset of, and time constant describing the development of, the $\dot{V}O_2$ slow component, respectively. An iterative process was used to minimize the sum of the squared errors between the fitted function and the observed values. $\dot{V}O_{2\text{baseline}}$ was defined as the mean $\dot{V}O_2$ measured over the final 90 s prior to each transition. The end-exercise $\dot{V}O_2$ was defined as the mean $\dot{V}O_2$ measured over the final 30 s of exercise. The absolute fundamental component amplitude for high-intensity exercise (Absolute A_p) was defined as the sum of $\dot{V}O_{2\text{baseline}}$ and A_p . The initial rate of change of $\dot{V}O_2$ was calculated from the onset of exercise for the Unprimed and Primed conditions ($d\dot{V}O_2/dt$) and also at a time point during the unprimed bout that was adjusted for the elevated baseline that was present after priming ($d\dot{V}O_2/dt$ adjusted). Because the asymptotic value (A_s) of the exponential term describing the $\dot{V}O_2$ slow component may represent a higher value than is actually reached at the end of the exercise, the actual amplitude of the $\dot{V}O_2$ slow component at the end of exercise was defined as A_s' . The amplitude of the $\dot{V}O_2$ slow component was also described relative to the entire $\dot{V}O_2$ response and without reliance on modeling-derived parameters as the difference between $\dot{V}O_2$ at minute 2 (average from 105-135 s) and end-exercise ($\Delta\dot{V}O_{2(6-2)}$).

[PCr] data were expressed as the percentage change relative to the initial resting baseline (i.e., the value prior to R→M Unprimed, which was assumed to represent 100%). [PCr] data were modeled using equation 1 with time delay fixed at $t = 0$ (50). For moderate exercise, the fit included all data from exercise onset to the end of exercise whereas for high-intensity exercise, the fitting window was constrained from $t = 0$ to the time point at which a departure from fundamental mono-exponentiality occurred as judged from visual inspection of a plot of the residuals of the fit. Baseline and end-exercise [PCr] were defined as the mean [PCr] measured over the final 30 s prior to each transition and the final 30 s of exercise, respectively. The initial rate of change of [PCr] was determined in the same manner as $\dot{V}O_2$ (see above) and the [PCr] slow component was calculated as the difference between end-exercise [PCr] and the value indicated by equation 1 at $t = 360$. The [PCr] slow component was also described relative to the entire [PCr] response and as $\Delta[\text{PCr}]_{(6-2)}$ (see above).

The raw EMG data were filtered with a 20 Hz high-pass second-order Butterworth filter to remove contamination from movement artifacts. The signal was then rectified and low-pass filtered at a frequency of 50 Hz to produce a linear envelope. For the 3-s MVCs, the average iEMG was calculated for 1 s intervals and the highest value was defined as the iEMG MVC. For the incremental bout, the average iEMG was calculated for 15 s intervals throughout exercise and the iEMG for each work rate was defined as the average iEMG from 15-75 s of exercise. Results from pilot testing indicated that loads that would require ~15% and ~30% of the iEMG MVC estimated in this manner would be appropriate for moderate- and high-intensity knee-extension exercise, respectively; therefore, loads for the work-to-work bouts were determined accordingly. For the work-to-work bouts, average iEMG was calculated for 60 s intervals

throughout exercise and these values were normalized to the iEMG MVC recorded prior to the bout. Data from repeat trials were averaged and ΔiEMG_{6-1} was defined as the difference between the average iEMG over the last 60 s of exercise and the average from 0-60 s. The average iEMG over each entire bout was also calculated as a gross indicator of the intensity of the bout. Finally, $\Delta\dot{V}O_2/\Delta\text{iEMG}$ was calculated at 60 s time points throughout exercise.

Statistics. The parameters derived from the modelling of the $\dot{V}O_2$ and [PCr] data for R→M and M→H Unprimed and Primed were compared using paired *t*-tests. The iEMG and intramuscular pH data were also analyzed using paired *t*-tests, both for comparisons of the unprimed vs. primed conditions and for comparisons of start vs. end-exercise values within conditions. Time dependent changes of $\Delta\dot{V}O_2/\Delta\text{iEMG}$ were analyzed using repeated measures analysis of variance with Fisher's least significant difference tests, as appropriate, to identify the location of statistically significant differences. Significance was accepted at $P < 0.05$. Results are reported as mean \pm SD.

Results

The average normalized iEMG for R→M Unprimed and R→M Primed was $13 \pm 5\%$ and $15 \pm 4\%$ of that measured during the MVC, respectively. The average normalized iEMG for M→H Unprimed and M→H Primed was $34 \pm 6\%$ and $34 \pm 7\%$ of that measured during the MVC, respectively. The average iEMG for the M→H bout was significantly greater than the average iEMG for the R→M bout in both the Unprimed and Primed conditions ($P < 0.01$).

Effect of Priming on $\dot{V}O_2$ and [PCr] Kinetics during Rest-to-Moderate-Intensity Exercise

The group mean $\dot{V}O_2$ responses for R→M Unprimed and R→M Primed are illustrated in Figure 1 (top panel) and the response parameters are presented in Table 1. Baseline $\dot{V}O_2$ was significantly elevated for R→M Primed; however, end-exercise $\dot{V}O_2$ was not significantly different between conditions. Similarly, the phase II $\dot{V}O_2$ τ , amplitude and $d[\dot{V}O_2]/dt$ were not significantly altered by priming.

The group mean [PCr] responses for R→M Unprimed and R→M Primed are illustrated in Figure 1 (bottom panel) and the response parameters are presented in Table 2. Baseline [PCr] was significantly reduced for R→M Primed; however, end-exercise [PCr] was not significantly different between conditions. Similarly, the [PCr] τ and $d[\text{PCr}]/dt$ were not significantly different. However, the [PCr] amplitude was significantly reduced by priming ($21 \pm 7\%$ and $14 \pm 5\%$ for R→M Unprimed and R→M Primed, respectively).

Effect of Priming on $\dot{V}O_2$ and [PCr] Kinetics during Moderate-to-High-Intensity Exercise

The group mean $\dot{V}O_2$ responses for M→H Unprimed and M→H Primed are illustrated in Figure 1 (top panel) and the response parameters are presented in Table 3. Baseline and end-exercise $\dot{V}O_2$ were not significantly

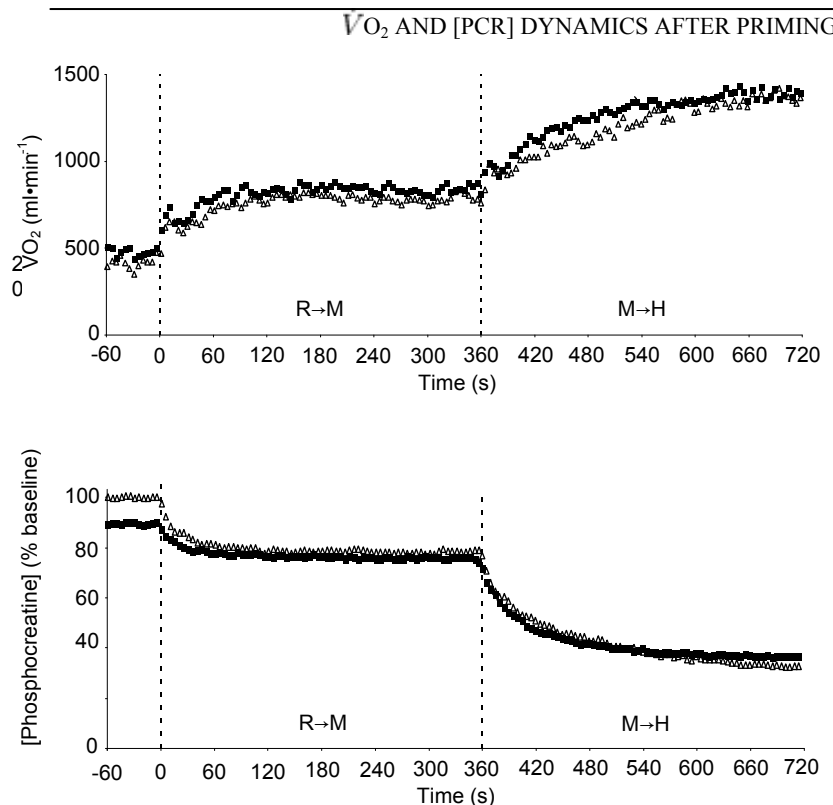

Fig. 1. Group mean pulmonary $\dot{V}O_2$ response (upper panel) and intramuscular [PCr] hydrolysis response (lower panel) during R→M/M→H exercise transitions. Δ , the unprimed condition; \blacksquare , the primed condition. Vertical dashed lines represent the transitions in work rate. Notice the slower $\dot{V}O_2$ and [PCr] responses in M→H compared to R→M and the “trimming out” of the $\dot{V}O_2$ and [PCr] slow components following priming.

affected by priming. The phase II $\dot{V}O_2$ τ and amplitude were also not significantly different between conditions. However, there was a tendency for the fundamental $\dot{V}O_2$ absolute amplitude to be increased for M→H Primed ($P = 0.09$). Similarly, the phase II $d[\dot{V}O_2]/dt$ at exercise onset tended to be greater after priming ($P=0.07$) and this difference was statistically significant with the baseline adjustment. The $\dot{V}O_2$ slow component time delay was not significantly different between conditions. However, the $\dot{V}O_2$ slow component amplitude in both absolute and relative terms was significantly reduced by priming, as was $\Delta\dot{V}O_{2(6-2)}$ (see Figures 1 and 2).

The group mean [PCr] responses for M→H Unprimed and M→H Primed are illustrated in Figure 1 (bottom panel) and the response parameters are presented in Table 4. Baseline and end-exercise [PCr] were not significantly affected by priming. The fundamental [PCr] τ , amplitude and $d[PCr]/dt$ were similarly unaffected by priming, and the $\Delta\dot{V}O_2/\Delta[PCr]$ was not significantly different between conditions. The time point at which the departure from fundamental phase mono-exponentiality occurred was not

Table 1. Parameters for the O₂ uptake kinetics during unprimed and primed rest-to-moderate-intensity exercise transitions.

	R→M Unprimed	R→M Primed
Baseline $\dot{V}O_2$, l/min	0.42 ± 0.05	0.47 ± 0.06*
Phase II τ , s	26 ± 8	25 ± 9
Phase II amplitude, l/min	0.37 ± 0.07	0.36 ± 0.08
$d\dot{V}O_2/dt$, l/min/min	1.00 ± 0.50	1.00 ± 0.40
$d\dot{V}O_2/dt$ adj, l/min/min	0.80 ± 0.40	1.00 ± 0.40
End-exercise $\dot{V}O_2$, l/min	0.80 ± 0.08	0.84 ± 0.09

Values are means ± SD. R→M Unprimed, rest to moderate exercise unprimed; R→M Primed, rest to moderate exercise primed; τ , time constant. *Significantly different from R→M Unprimed condition ($P < 0.05$).

Table 2. Parameters for the [PCr] dynamics during unprimed and primed rest-to-moderate-intensity exercise transitions.

	R→M Unprimed	R→M Primed
Baseline [PCr], %	100 ± 0	90 ± 6*
Fundamental τ , s	24 ± 16	22 ± 14
Fundamental amplitude, %	21 ± 7	14 ± 5*
$d[PCr]/dt$, %/min	75 ± 47	69 ± 82
$d[PCr]/dt$ adj, %/min	36 ± 13	69 ± 82
End-exercise [PCr], %	79 ± 7	75 ± 10

Values are means ± SD. R→M Unprimed, rest to moderate exercise unprimed; R→M Primed, rest to moderate exercise primed; %, % initial baseline; τ , time constant. *Significantly different from R→M Unprimed condition ($P < 0.05$).

significantly different between conditions. However, the [PCr] slow component amplitude in both absolute and relative terms was significantly reduced by priming, as was $\Delta[PCr]_{(6-2)}$ (see Figures 1 and 2). The total [PCr] response amplitude was also reduced by priming.

Comparison of $\dot{V}O_2$ and [PCr] Kinetics

There was no significant difference between the phase II $\dot{V}O_2$ τ and the fundamental [PCr] τ for R→M Unprimed, R→M Primed, M→H Unprimed or M→H Primed. Similarly, there was no significant difference between the relative $\dot{V}O_2$ and [PCr] component amplitudes for either M→H Unprimed or M→H Primed. The group mean phase II $\dot{V}O_2$ τ and fundamental [PCr] τ were 25% and 42% longer, respectively, during M→H Unprimed compared to R→M Unprimed, but the differences did not attain statistical significance ($P < 0.10$).

$\dot{V}O_2$ AND [PCr] DYNAMICS AFTER PRIMING

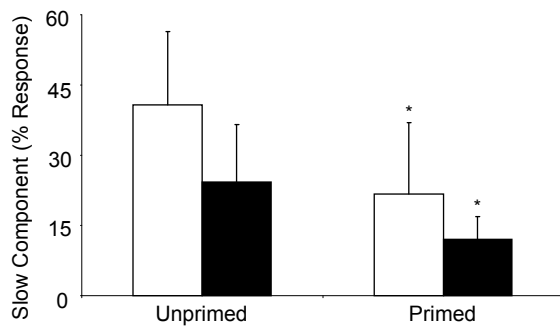

Fig. 2. Group mean \pm SD $\dot{V}O_2$ (open bars) and [PCr] (closed bars) slow component relative response amplitudes during M→H exercise in the unprimed and primed states. *Significant difference between the unprimed and primed conditions ($P < 0.05$).

Intramuscular pH and Blood [Lactate] Responses

The group mean intramuscular pH responses for R→M/M→H Unprimed and R→M/M→H Primed are illustrated in Figure 3. Intramuscular pH was significantly lower for R→M Primed compared to R→M Unprimed at baseline, minute 1 and minute 2; however, for minutes 3-6, there was no significant difference between conditions. Intramuscular pH was significantly higher for M→H Primed compared to M→H Unprimed at all time points other than baseline.

Baseline blood [lactate] was significantly elevated for R→M Primed compared to R→M Unprimed (R→M Unprimed: 0.7 ± 0.3 mM vs. R→M Primed: 1.7 ± 0.6 mM); however, at end exercise, there was no significant difference between conditions. Consequently, during R→M, Δ blood [lactate] was significantly reduced after priming (0.1 ± 0.2 mM and -0.5 ± 0.2 mM for R→M Unprimed and R→M Primed; respectively). For M→H, baseline blood [lactate] (M→H Unprimed: 0.8 ± 0.3 mM; M→H Primed: 1.2 ± 0.5 mM) and end-exercise blood [lactate] (M→H Unprimed: 1.8 ± 0.6 mM; M→H Primed: 1.7 ± 1.0 mM) were not significantly different between conditions; however, Δ blood [lactate] was significantly reduced after priming (1.0 ± 0.5 mM v. 0.5 ± 0.6 mM for M→H Unprimed and M→H Primed, respectively).

Table 3. Parameters for the O₂ uptake kinetics during unprimed and primed work-to-work high-intensity exercise transitions.

	M→H Unprimed	M→H Primed
Baseline $\dot{V}O_2$, l/min	0.78 ± 0.07	0.84 ± 0.11
Phase II τ , s	37 ± 5	38 ± 9
Phase II amplitude, l/min	0.35 ± 0.07	0.42 ± 0.06
Phase II $d\dot{V}O_2/dt$, l/min/min	0.56 ± 0.10	0.69 ± 0.18
Phase II $d\dot{V}O_2/dt$ adj, l/min/min	0.49 ± 0.27	$0.69 \pm 0.18^*$
Phase II Absolute $\dot{V}O_2$, l/min	1.13 ± 0.13	1.26 ± 0.11
$\dot{V}O_2$ SC time delay, s	127 ± 28	145 ± 73
$\dot{V}O_2$ SC amplitude, l/min	0.26 ± 0.15	$0.14 \pm 0.13^*$
$\dot{V}O_2$ SC relative amplitude, %	41 ± 16	$22 \pm 15^*$
$\Delta\dot{V}O_{2(6-2)}$, l/min	0.26 ± 0.16	$0.15 \pm 0.10^*$
End-exercise $\dot{V}O_2$, l/min	1.38 ± 0.10	1.40 ± 0.22

Values are means \pm SD. M→H Unprimed, moderate to high intensity exercise unprimed; M→H Primed, moderate to high intensity exercise primed; τ , time constant; SC, slow component. *Significantly different from M→H Unprimed condition ($P < 0.05$).

Table 4. Parameters for the [PCr] dynamics during unprimed and primed work-to-work high-intensity exercise transitions.

	M→H Unprimed	M→H Primed
Baseline [PCr], %	79 ± 8	76 ± 11
Fundamental τ , s	30 ± 5	32 ± 7
Fundamental amplitude, %	37 ± 11	34 ± 12
Fundamental absolute {PCr}, %	58 ± 19	59 ± 22
$d[PCr]/dt$, %/min	77 ± 27	65 ± 12
$d[PCr]/dt$ adj, %/min	71 ± 23	65 ± 12
Monoexponential departure, s	117 ± 29	139 ± 27
[PCr] SC amplitude, %	11 ± 5	$5 \pm 2^*$
Relative [PCr] SC amplitude, %	24 ± 12	$12 \pm 5^*$
$\Delta[PCr]_{(6-2)}$, %	10 ± 4	$5 \pm 3^*$
Total [PCr] amplitude, %	47 ± 8	$38 \pm 12^*$
End-exercise [PCr], %	30 ± 16	37 ± 23

Values are means \pm SD. M→H Unprimed, moderate to high intensity exercise unprimed; M→H Primed, moderate to high intensity exercise primed; %, % initial baseline; τ , time constant; SC, slow component. *Significantly different from M→H Unprimed condition ($P < 0.05$).

iEMG Responses

For both R→M Unprimed and R→M Primed, the mean iEMG during the sixth minute of exercise was not significantly different from mean iEMG during the first minute of exercise. For M→H Unprimed, the mean iEMG during the sixth minute of exercise was significantly greater than mean iEMG during the first minute of exercise; however, for M→H Primed, there was no significant difference. The $\Delta iEMG_{(6-1)}$ was significantly greater for M→H Unprimed compared to the other three conditions, which did not differ. The group mean iEMG for the first and sixth minute of exercise for both moderate and high-intensity prone knee-extension exercise in the unprimed and primed states are depicted in Figure 4.

The group mean $\Delta\dot{V}O_2/\Delta iEMG$ response for R→M/M→H Unprimed and R→M/M→H Primed is illustrated in Figure 5. Post minute 2, $\Delta\dot{V}O_2/\Delta iEMG$ remained stable throughout both R→M bouts and there was no significant difference for $\Delta\dot{V}O_2/\Delta iEMG$ between R→M Unprimed and R→M Primed at any time point. Similarly, the $\Delta\dot{V}O_2/\Delta iEMG$ was not significantly different for the M→H Unprimed and M→H Primed bouts at any time point and the ratio remained constant beyond two min of exercise in both cases.

DISCUSSION

The principal original finding of this investigation was that the performance of prior high-intensity exercise did not shorten either the [PCr] fundamental τ or the $\dot{V}O_2$ τ_p during rest-to-moderate-intensity (R→M) or moderate-to-high-intensity (M→H) prone knee-extension exercise. This suggests that despite the prone posture assumed by the subjects, the fundamental [PCr] and $\dot{V}O_2$ response kinetics were not limited by O₂ availability, even in the higher-order fibers that would be expected to be recruited in the M→H condition and which are known to be especially sensitive to limitations in O₂ supply (6, 45). However, priming did reduce the amplitudes of the [PCr] and $\dot{V}O_2$ slow components during M→H exercise, in addition to blunting the intramuscular pH response.

$\dot{V}O_2$ AND [PCr] DYNAMICS AFTER PRIMING

Fig 3. Group mean \pm SD intramuscular pH responses at 60-s intervals during R \rightarrow M/M \rightarrow H exercise transitions. Δ , the unprimed condition; \blacksquare , the primed condition. Vertical dashed lines denote the transitions in work rate. *Significant difference between the unprimed and primed conditions at that time point ($P < 0.05$). #Significant difference between baseline and end exercise for R \rightarrow M Primed ($P < 0.05$). †Significant difference between baseline and end exercise for M \rightarrow H Unprimed ($P < 0.05$). Notice the attenuated intramuscular pH response during M \rightarrow H exercise after priming.

These latter alterations appear to be linked to changes in motor unit recruitment patterns: the iEMG between the first and the final minute of M \rightarrow H exercise was significantly increased in the unprimed, but not the primed condition, and Δ iEMG₍₆₋₁₎ was significantly decreased during M \rightarrow H exercise after priming.

Effect of Priming on Rest-to-Moderate-Intensity Exercise

Consistent with our hypothesis, the performance of prior high-intensity exercise did not reduce the phase II $\dot{V}O_2$ τ in the transition from rest to moderate-intensity exercise. It is well established that moderate-intensity cycling in the upright position is unaffected by either moderate- or high-intensity priming (9, 19, 22, cf. 24) and we have previously shown a similar lack of prior-exercise effect during moderate-intensity cycling in the supine position (17). In the latter study, τ_p for moderate exercise was similar in the supine and upright positions, but the ratio between the change in the deoxygenated hemoglobin/myoglobin signal derived from near infra-red spectroscopy (NIRS) and the change in $\dot{V}O_2$ was significantly greater for supine cycling (17). This suggests that an enhanced fractional O₂ extraction in the type I fibers that would be recruited at this intensity (27, 39) counteracted the reduced O₂ availability consequent to the supine posture such that $\dot{V}O_2$ kinetics was not slowed. In the present study, the τ_p value for R \rightarrow M Unprimed (26 ± 8 s) was typical for young healthy subjects performing moderate-intensity exercise, implying that an increased fractional O₂ extraction might have offset any perfusion compromise associated with the prone body position. In this case, increasing muscle O₂ delivery through the completion of a priming bout of prior exercise would not be expected to reduce τ_p (17, 47).

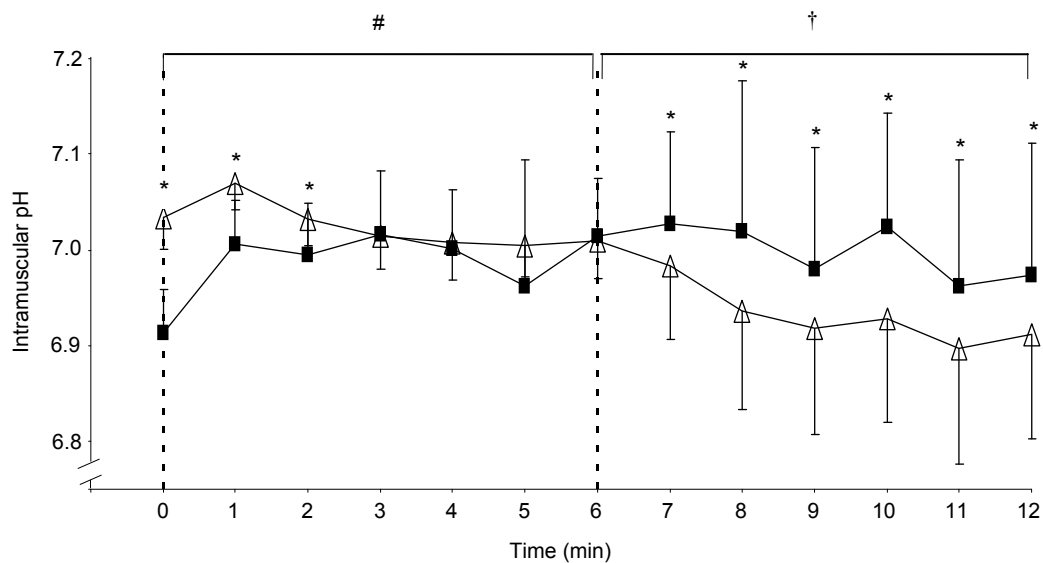
The fundamental [PCr] τ in the transition from rest to moderate-intensity exercise was also unaffected by priming. The $\dot{V}O_2$ and [PCr] τ values during R \rightarrow M were

not different either before or after priming, data which are consistent with the notion that mitochondrial respiration is principally under feedback control through the CK reaction (23, 32, 35, 43, 46). A direct proportionality between the kinetics of [PCr] and the kinetics of $\dot{V}O_2$ has been reported previously (4, 44, 50-53). However, the [PCr] fundamental amplitude was significantly reduced by priming in the present study whereas the $\dot{V}O_2$ amplitude was unchanged. We and others have previously reported that priming significantly increases the total hemoglobin/myoglobin in the quadriceps as assessed using NIRS during prone knee-extension exercise (30, 41). The reduced [PCr] during primed R \rightarrow M exercise might, therefore, be a consequence of increased muscle blood flow and O₂ delivery, which permitted the same metabolic rate to be achieved with altered redox and phosphorylation potentials (18, 28, 63). Similarly, Haseler et al. (26) reported that the inspiration of 100% O₂ reduced the end-exercise [PCr], but without changing the τ or initial rate of change of [PCr] during exercise at 60% peak work rate.

Another explanation for the apparent [PCr] sparing we observed for R \rightarrow M Primed might be that it represented the net effect of two simultaneously occurring responses in diverse segments of the fiber pool. Despite the five-minute rest we allowed after completion of the initial work-to-work bout, [PCr] had not returned to its baseline level prior to the onset of the second work-to-work bout. PCr is re-synthesized predominantly via oxidative phosphorylation (1, 25); however, re-synthesis does not appear to occur in contracting fibers even during moderate-intensity exercise when O₂ availability is presumed to be sufficient (50, 54). Because the MRS signal represents net [PCr] changes in the entire area of interrogation, it is possible that the measured [PCr] reflected not only PCr hydrolysis in active fibers, but also PCr recovery in inactive higher-order fibers that had contributed during the preceding high-intensity exercise bout.

$\dot{V}O_2$ AND [PCr] DYNAMICS AFTER PRIMING

Fig. 4. Group mean \pm SD integrated electromyogram responses for minute 1 (open bars) and minute 6 (closed bars) during R→M and M→H exercise transitions in the unprimed and primed states. *Significant difference between minute 1 and minute 6 within condition ($P < 0.05$). †Significantly greater $\Delta iEMG_{(6-1)}$ for M→H Unprimed compared to all other conditions.

Effect of Priming on Moderate-to-High-Intensity Exercise

The group mean phase II $\dot{V}O_2$ τ and fundamental [PCr] τ were substantially slower (by $\sim 25\%$ and $\sim 42\%$, respectively) during M→H Unprimed compared to R→M Unprimed, although inter-individual variability precluded the attainment of statistical significance. This is consistent with previous studies that have reported slower $\dot{V}O_2$ kinetics (16, 17, 34, 60, 61) and slower [PCr] kinetics (34) when work rate is incremented from an elevated baseline metabolic rate. While it has been suggested that this effect might be related to a greater contribution from anaerobic glycolysis or slower muscle O₂ delivery kinetics (28), the observation of slower kinetics is also consistent with a greater proportional involvement of muscle fibers that are positioned higher in the recruitment hierarchy (e.g., type II fibers; 27, 39, 61). There is evidence that, relative to type I fibers, type II fibers have slower $\dot{V}O_2$ kinetics (12, 49) and are less able to defend the microvascular O₂ pressure during transitions to a higher metabolic rate (6, 45).

Contrary to our hypothesis, the performance of prior high-intensity exercise did not reduce the phase II $\dot{V}O_2$ τ during moderate-to-high-intensity exercise. However, the phase II $d[\dot{V}O_2]/dt$ was significantly greater during M→H Primed. A faster rate of change during the fundamental phase of the $\dot{V}O_2$ response with unaltered τ_p suggests that $\dot{V}O_2$ was projecting to a higher asymptotic amplitude after priming; however, the $\sim 13\%$ increase in fundamental absolute amplitude did not reach statistical significance ($P = 0.09$). We also observed a significant reduction in the amplitude of the $\dot{V}O_2$ slow component during M→H Primed, expressed both in absolute and relative terms, and as $\Delta\dot{V}O_{2(6-2)}$. A reduced $\dot{V}O_2$ slow component with increased fundamental component amplitude is typically reported for high-intensity upright cycling after priming (2, 7-9, 14, 21, 29, 36, 62) and we have previously shown a similar effect during M→H upright cycling where a lengthened τ_p was present compared to transitions to the same work rate from an unloaded baseline (14). However, for M→H cycling in the supine position and in other situations where perfusion limitations result in slower phase II $\dot{V}O_2$ kinetics, a priming-induced

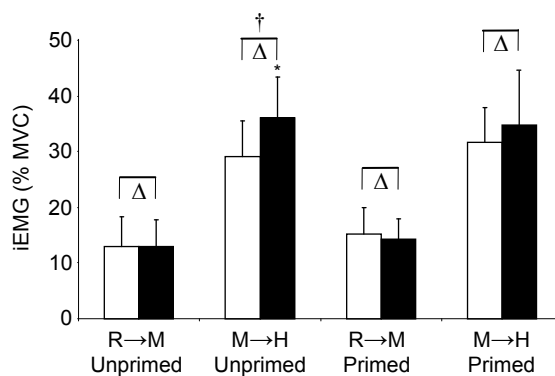
reduction of τ_p with unchanged response-phase amplitudes has been observed (17, 29, 37). This appears to indicate that the adequacy of O₂ delivery relative to metabolic rate in the unprimed control condition determines whether priming alters response phase amplitudes or τ_p during subsequent high-intensity exercise (17, 47).

We hypothesized that priming would reduce τ_p during M→H because the knee-extension exercise that was employed in the present study was performed in the prone position (i.e., with the exercising musculature at heart level). It has been reported that, consequent to this body position, the gravitational assist to muscle blood flow is absent, muscle perfusion pressure is reduced and the adaptation of O₂ delivery is slowed (42). We have previously shown that fibers involved in M→H cycling (i.e., higher-order fibers) cannot increase estimated muscle fractional O₂ extraction sufficiently to counteract reduced O₂ availability during supine cycling, resulting in a further slowing of τ_p (17). Under these circumstances, the increased muscle O₂ delivery following priming resulted in a shortening of τ_p back to the upright cycling value (17). In the present study, the τ_p values we observed for M→H Unprimed were similar to what we have reported previously for upright M→H cycling (~ 38 s; 14, 17). Therefore, it appears that priming did not significantly reduce τ_p during M→H because the characteristic slowing of phase II $\dot{V}O_2$ kinetics for work-to-work exercise was not amplified by the prone body position. The reason for this disparity compared to supine cycling is unclear. However, the volume of muscle recruited to perform the knee-extension exercise in our study would likely be considerably less than during supine cycling such that the muscle might have been relatively well perfused despite the prone body position.

The parameters of the $\dot{V}O_2$ and [PCr] kinetics in the fundamental phase during M→H were not different either before or after priming. Similar to the $\dot{V}O_2$ response, priming did not affect the fundamental [PCr] τ for M→H Primed, but did reduce the amplitude of the [PCr] slow component resulting in a $\sim 20\%$ reduction in [PCr] degradation after six minutes of high-intensity exercise. As mentioned earlier, a sparing of PCr degradation could occur as a consequence of increased O₂ availability. It is well established that priming facilitates both convective and diffusive components of muscle O₂ delivery (2, 3, 7, 13, 15, 21, 30) and it has been suggested that increased intracellular PO₂ provides feed-forward modulation that allows a given rate of ATP flux to be achieved with less perturbation of cellular phosphorylation and redox potentials (18, 28, 63). A higher phosphorylation potential (i.e., [ATP]/[ADP][Pi]) that allows a given rate of oxidative phosphorylation to be achieved for less PCr degradation would be expected to particularly impact type II fibers; these fibers have a higher total creatine content and require greater PCr hydrolysis to attain a given $\dot{V}O_2$ (23, 32, 43).

A potential explanation for the reduced [PCr] slow component and consequent [PCr] sparing for M→H Primed is that priming altered motor unit recruitment patterns during subsequent exercise. Indeed, the increase in iEMG from minute 1 to minute 6 was significant during M→H Unprimed, but not for M→H Primed (Figure 4). This blunting of the $\Delta iEMG$ during high-intensity exercise is similar to what we have reported previously for M→H upright cycling after priming (14),

$\dot{V}O_2$ AND [PCr] DYNAMICS AFTER PRIMING

Fig. 5 Group mean \pm SD $\Delta\dot{V}O_2/\Delta iEMG$ responses at 60-s intervals during R→M/M→H exercise transitions. Δ , the unprimed condition; \blacksquare , the primed condition. Vertical dashed line denotes the transition from the moderate- to high-intensity work rate. Notice the relative constancy of $\Delta\dot{V}O_2/\Delta iEMG$ after two minutes of exercise during M→H Unprimed and that this ratio is unchanged after priming

but contrasts with what we have found during supine cycling (17). The mechanism(s) responsible for the [PCr] slow component have yet to be fully elucidated. However, a close coupling between this phenomenon and the $\dot{V}O_2$ slow component has been shown (51-53). This indicates that the $\dot{V}O_2$ slow component reflects a time-dependent increase in the rate of ATP turnover required for a given muscle power production and is consistent with the prevailing theory that the [PCr] and $\dot{V}O_2$ slow components are related to the progressive recruitment of less efficient type II muscle fibers as high-intensity exercise proceeds (5, 38, 39, 55). The reduced iEMG response in the present study is consistent with a growing body of evidence that suggests that delayed-onset fiber activation may be reduced after priming and may be responsible for the observed reductions in the [PCr] and $\dot{V}O_2$ slow components (2, 7, 14, 41). We observed a relatively stable $\Delta\dot{V}O_2/\Delta iEMG$ after two minutes of exercise during M→H Unprimed that was unchanged after priming (Figure 5, upper panel). This constancy suggests that changes in neuromuscular activity approximately paralleled changes in $\dot{V}O_2$ throughout both M→H bouts and that the reduction of the $\dot{V}O_2$ slow component during M→H Primed was predominantly due to changes in neuromuscular activity.

In addition to the reductions in the [PCr] and $\dot{V}O_2$ slow components, the accumulation of blood lactate and the fall in intramuscular pH was significantly blunted following priming (Figure 3). These results are consistent with previous reports (20, 30, 41). It is unclear whether the higher intramuscular pH following priming is a cause or a consequence of the reduced neuromuscular activity and energy turnover. On the one hand, a reduced rate of fatigue development, for which pH might serve as a proxy, would reduce the requirement for additional higher-order fiber recruitment to maintain power production and, in turn, reduce the [PCr] and $\dot{V}O_2$ slow components (5, 38, 39). On the other hand, a reduction in type II fiber recruitment as a consequence of other factors (10) would itself reduce the rate of lactate production and

the fall in pH. The reciprocity of the [PCr] and pH responses to exercise is reflected in the CK equilibrium reaction, which indicates that a low pH will require a greater fall in [PCr] to produce the same [ADP] stimulus to oxidative phosphorylation, and *vice versa* (11). However, irrespective of the mechanistic bases for the effect, the reduced fall in both [PCr] and pH is likely to underpin the enhanced exercise tolerance that has been reported during high-intensity exercise following priming (2, 33, 48).

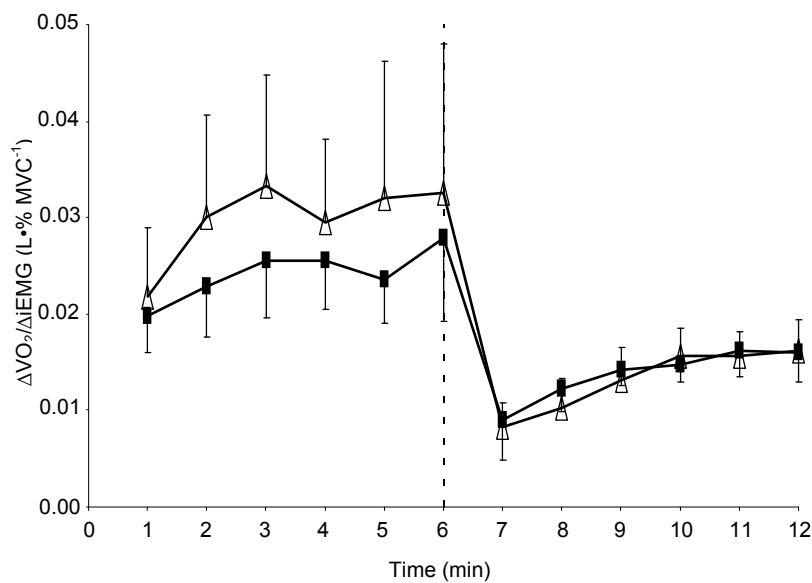
In conclusion, we have shown that prior high-intensity exercise did not reduce either the [PCr] fundamental τ or the $\dot{V}O_2$ τ_p during prone knee-extension exercise, even during moderate-to-high-intensity transitions that would be expected to involve a greater contribution from higher-order fibers that are especially sensitive to limitations in O₂ supply (6, 45). It appears that the prone body position that was a feature of our study did not amplify the characteristic slowing of [PCr] or $\dot{V}O_2$ kinetics for work-to-work exercise such that an enhanced O₂ delivery following priming did not impact on the time constants of [PCr] or $\dot{V}O_2$. Priming significantly reduced the amplitudes of the [PCr] and $\dot{V}O_2$ slow components, attenuated the fall in pH, and reduced the $\Delta iEMG$ during high-intensity exercise. These effects indicate a reduced rate of fatigue development following priming, which might be linked to a reduced requirement for delayed-onset muscle fiber activation as high-intensity exercise proceeds.

DISCLOSURES

No conflicts of interest were declared by the author(s).

REFERENCES

1. **Arnold DL, Matthews PM, Radda GK.** Metabolic recovery after exercise and the assessment of mitochondrial function *in Vivo* in human skeletal muscle by means of ³¹P NMR. *Magn Reson Med* 1: 307-315, 1984.
2. **Bailey SJ, Vanhatalo A, Wilkerson DP, DiMenna FD, Jones AM.** Optimizing the 'priming' effect: influence of prior exercise and recovery duration on O₂ uptake kinetics and severe-intensity exercise tolerance. *J Appl Physiol* 107: 1743-1756, 2010.
3. **Bangsbo J, Krstrup P, González-Alonso J, Saltin B.** ATP production and efficiency of human skeletal muscle during intense exercise: effect of previous exercise. *Am J Physiol Endocrinol Metab* 280: 956-964, 2001.
4. **Barstow TJ, Buchthal S, Zanconato S, Cooper DM.** Muscle energetics and pulmonary oxygen uptake kinetics during moderate exercise. *J Appl Physiol* 77: 1742-1749, 1994.
5. **Barstow TJ, Jones AM, Nguyen PH, Casaburi R.** Influence of muscle fiber type and pedal frequency on oxygen uptake kinetics of heavy exercise. *J Appl Physiol* 81: 1642-1650, 1996.
6. **Behnke BJ, McDonough P, Padilla DJ, Musch TI, Poole DC.** Oxygen exchange profile in rat muscles of contrasting fibre types. *J Physiol* 549: 597-605, 2003.
7. **Burnley M, Doust JH, Ball D, Jones AM.** Effects of prior heavy exercise on V̇O₂ kinetics during heavy exercise are related to changes in muscle activity. *J Appl Physiol* 93: 167-174, 2002.
8. **Burnley M, Doust JH, Carter H, Jones AM.** Effects of prior exercise and recovery duration on oxygen uptake kinetics during heavy exercise in humans. *Exp Physiol* 86: 417-425, 2001.
9. **Burnley M, Jones AM, Carter H, Doust JH.** Effects of prior heavy exercise on phase II pulmonary oxygen uptake kinetics during heavy exercise. *J Appl Physiol* 89: 1387-1396, 2000.
10. **Burnley M, Koppo K, Jones AM.** 'Priming exercise' and V̇O₂ kinetics. In Jones AM and Poole DC (Eds) *Oxygen Uptake Kinetics in Sport, Exercise and Medicine*, Routledge, London and New York, pp. 230-260, 2005.
11. **Conley KE, Kemper WF, Crowther GJ.** Limits to sustainable muscle performance: interaction between glycolysis and oxidative phosphorylation. *J Exp Biol* 204: 3189-3194, 2001.
12. **Crow MT, Kushmerick MJ.** Chemical energetics of slow- and fast-twitch muscles of the mouse. *J Gen Physiol* 79: 147-166, 1982.
13. **DeLorey DS, Kowalchuk JM, Paterson DH.** Effects of prior heavy-intensity exercise on pulmonary O₂ uptake and muscle deoxygenation kinetics in young and older adult humans. *J Appl Physiol* 97: 998-1005, 2004.
14. **DiMenna FJ, Wilkerson DP, Burnley M, Jones AM.** Influence of priming exercise on pulmonary O₂ uptake kinetics during transitions to high-intensity exercise from an elevated baseline. *J Appl Physiol* 105: 538-546, 2008.
15. **DiMenna FJ, Wilkerson DP, Burnley M, Bailey SJ, Jones AM.** Influence of priming exercise on pulmonary O₂ uptake kinetics during transitions to high-intensity exercise at extreme pedal rates. *J Appl Physiol* 106: 432-442, 2009a.
16. **DiMenna FJ, Wilkerson DP, Burnley M, Bailey SJ, Jones AM.** Influence of extreme pedal rates on pulmonary O₂ uptake kinetics during transitions to high-intensity exercise from an elevated baseline. *Respir Physiol Neurobiol* 169: 16-23, 2009b.
17. **DiMenna FJ, Wilkerson DP, Burnley M, Bailey SJ, Jones AM.** Priming exercise speeds pulmonary O₂ uptake kinetics during supine 'work-to-work' high-intensity cycle exercise. *J Appl Physiol*, submitted.
18. **Erecinska M, Wilson DF.** Regulation of cellular energy metabolism. *J Membr Biol* 70: 1-14, 1982.
19. **Ferreira LF, Koga S, Barstow TJ.** Dynamics of noninvasively estimated microvascular O₂ extraction during ramp exercise. *J Appl Physiol* 103:1999-2004, 2007.
20. **Forbes SC, Raymer GH, Kowalchuk JM, Thompson RT, Marsh GD.** Effects of recovery time on phosphocreatine kinetics during repeated bouts of heavy-intensity exercise. *Eur J Appl Physiol* 103: 665-675, 2008.
21. **Fukuba Y, Hayashi N, Koga S, Yoshida T.** V̇O₂ kinetics in heavy exercise is not altered by prior exercise with a different muscle group. *J Appl Physiol* 92: 2467-2474, 2002.
22. **Gerbino A, Ward SA, Whipp BJ.** Effects of prior exercise on pulmonary gas-exchange kinetics during high-intensity exercise in humans. *J Appl Physiol* 80: 99-107, 1996.
23. **Glancy B, Barstow T, Willis WT.** Linear relation between time constant of oxygen uptake kinetics, total creatine, and mitochondrial content *in vitro*. *Am J Physiol Cell Physiol* 294: C79-87, 2008.
24. **Gurd BJ, Scheuermann BW, Paterson DH, Kowalchuk JM.** Prior heavy-intensity exercise speeds V̇O₂ kinetics during moderate-intensity exercise in young adults. *J Appl Physiol* 98: 1371-1378, 2005.
25. **Harris RC, Edwards RHT, Hultman E, Nordesjö LO, Ny Lind B, Sahlin K.** The time course of phosphorylcreatine resynthesis during recovery of the quadriceps muscle in man. *PflügersArch* 367: 137-142, 1976.
26. **Haseler LJ, Kindig CA, Richardson RS, Hogan MC.** The role of oxygen in determining phosphocreatine onset kinetics in exercising humans. *J Physiol* 558: 985-992, 2004.
27. **Henneman E, Mendell LM.** Functional organisation of motoneuron pool and its inputs. In Brooks VB (Ed) *Handbook of Physiology I vol. II, American Physiological Society, Bethesda*, pp. 423-507 (part 1), 1981.
28. **Hughson RL.** Regulation of V̇O₂ on-kinetics by O₂ delivery. In A.M. Jones and D.C. Poole (Eds) *Oxygen Uptake Kinetics in Sport, Exercise and Medicine*, Routledge, London and New York, pp. 185-211, 2005.
29. **Jones AM, Berger NJ, Wilkerson DP, Roberts CL.** Effects of "priming" exercise on pulmonary O₂ uptake and muscle deoxygenation kinetics during heavy-intensity cycle exercise in the supine and upright positions. *J Appl Physiol* 101: 1432-1441, 2006.

$\dot{V}O_2$ AND [PCR] DYNAMICS AFTER PRIMING

30. **Jones AM, Fulford J, Wilkerson DP.** Influence of prior exercise on muscle [phosphorylcreatine] and deoxygenation kinetics during high-intensity exercise in men. *Exp Physiol* 93: 468-478, 2008.
31. **Jones AM, Koppo K, Burnley M.** Effects of prior exercise on metabolic and gas exchange responses to exercise. *Sports Med* 33: 949-971, 2003.
32. **Jones AM, Wilkerson DP, Fulford J.** Influence of dietary creatine supplementation on muscle phosphocreatine kinetics during knee-extensor exercise in humans. *Am J Physiol Regul Integr Comp Physiol* 296: R1078-1087, 2009.
33. **Jones AM, Wilkerson DP, DiMenna F, Fulford J, Poole DC.** Muscle metabolic responses to exercise above and below the "critical power" assessed using ³¹P-MRS. *Am J Physiol Regul Integr Comp Physiol* 294: R585-593, 2008.
34. **Jones AM, Wilkerson DP, and Fulford J.** Muscle [PCr] dynamics following the onset of exercise in humans: the influence of baseline work-rate. *J Physiol* 586: 889-898, 2008.
35. **Kindig CA, Howlett RA, Stary CM, Walsh B, Hogan AC.** Effects of acute creatine kinase inhibition on metabolism and tension development in isolated single myocytes. *J Appl Physiol* 98: 541-549, 2005.
36. **Koppo K, Bouckaert J.** The effect of prior high-intensity cycling exercise on the $\dot{V}O_2$ kinetics during high-intensity cycling exercise is situated at the additional slow component. *Int J Sports Med* 22: 21-26, 2001.
37. **Koppo K, Bouckaert J.** Prior arm exercise speeds the $\dot{V}O_2$ kinetics during arm exercise above the heart level. *Med Sci Sports Exerc* 37: 613-619, 2005.
38. **Krustrup P, Soderlund K, Mohr M, Bangsbo J.** Slow-twitch fiber glycogen depletion elevates moderate-exercise fast-twitch fiber activity and O₂ uptake. *Med Sci Sports Exerc* 36: 973-982, 2004a.
39. **Krustrup P, Soderlund K, Mohr M, Bangsbo J.** The slow component of oxygen uptake during intense, sub-maximal exercise in man is associated with additional fibre recruitment. *Pflugers Arch* 447: 855-866, 2004b.
40. **Lamarra N, Whipp BJ, Ward SA, Wasserman K.** Effect of interbreath fluctuations on characterizing exercise gas exchange kinetics. *J Appl Physiol* 62: 2003-2012, 1987.
41. **Layec G, Bringard A, Le Fur Y, Vilmen C, Micallef J-P, Perrey S, Cozzone PJ, Bendahan D.** Effects of a prior high-intensity knee-extension exercise on muscle recruitment and energy cost: a combined local and global investigation in humans. *Exp Physiol* 94:704-719, 2009.
42. **MacDonald MJ, Shoemaker JK, Tschakovsky ME, Hughson RL.** Alveolar oxygen uptake and femoral artery blood flow dynamics in upright and supine leg exercise in humans. *J Appl Physiol* 85: 1622-1628, 1998.
43. **Mahler M.** First-order kinetics of muscle oxygen consumption, and an equivalent proportionality between QO₂ and phosphorylcreatine level. Implications for the control of respiration. *J Gen Physiol* 86: 135-165, 1985.
44. **McCreary CR, Chilibeck PD, Marsh GD, Paterson DH, Cunningham DA, Thompson RT.** Kinetics of pulmonary oxygen uptake and muscle phosphates during moderate-intensity calf exercise. *J Appl Physiol* 81: 1331-1338, 1996.
45. **McDonough P, Behnke BJ, Padilla DJ, Musch TI, Poole DC.** Control of microvascular oxygen pressures in rat muscles comprised of different fiber types. *J Physiol*. 563: 903-913, 2005.
46. **Meyer RA.** A linear model of muscle respiration explains monoexponential phosphocreatine changes. *Am J Physiol Cell Physiol* 254: C548-C553, 1988.
47. **Poole DC, Barstow TJ, McDonough P, Jones AM.** Control of oxygen uptake during exercise. *Med Sci Sports Exerc* 40: 462-474, 2008
48. **Raymer GH, Forbes SC, Kowalchuk JM, Thompson RT, Marsh GD.** Prior exercise delays the onset of acidosis during incremental exercise. *J Appl Physiol* 102: 1799-805, 2007.
49. **Reggiani C, Potma EJ, Bottinelli R, Canepari M, Pellegrino MA, and Stienen GJM.** Chemo-mechanical energy transduction in relation to myosin isoform composition in skeletal muscle fibres of the rat. *J Physiol* 502: 449-460, 1997.
50. **Rossiter HB, Ward SA, Doyle VL, Howe FA, Griffiths JR, and Whipp BJ.** Inferences from pulmonary O₂ uptake with respect to intramuscular [PCr] kinetics during moderate exercise in humans. *J Physiol* 518: 921-932, 1999.
51. **Rossiter HB, Ward SA, Kowalchuk JM, Howe FA, Griffiths JR, and Whipp BJ.** Effects of prior exercise on oxygen uptake and phosphocreatine kinetics during high-intensity knee-extension exercise in humans. *J Physiol* 537: 291-303, 2001.
52. **Rossiter HB, Ward SA, Howe FA, Kowalchuk JM, Griffiths JR, and Whipp BJ.** Dynamics of intramuscular ³¹P-MRS P_i peak splitting and the slow components of PCr and O₂ uptake during exercise. *J Appl Physiol* 93: 2059-2069, 2002.
53. **Rossiter HB, Ward SA, Kowalchuk JM, Howe FA, Griffiths JR, and Whipp BJ.** Dynamic asymmetry of phosphocreatine concentration and O₂ uptake between the on- and off-transients of moderate- and high-intensity exercise in humans. *J Physiol* 541: 991-1002, 2002.
54. **Rossiter HB, Howe FA, and Ward SA.** Intramuscular phosphate and pulmonary $\dot{V}O_2$ kinetics during exercise. In A.M. Jones and D.C. Poole (Eds) *Oxygen Uptake Kinetics in Sport, Exercise and Medicine*, Routledge, London and New York, pp. 154-184, 2005.
55. **Sabapathy S, Schneider, DA, and Morris, NR.** The $\dot{V}O_2$ slow component: relationship between plasma ammonia and EMG activity. *Med Sci Sports Exerc* 37: 1502-1509, 2005.
56. **Taylor DJ, Bore PJ, Styles P, Gadian DG, and Radda GK.** Bioenergetics of intact human muscle. A ³¹P nuclear magnetic resonance study. *Mol Biol Med* 1: 77-94, 1983.
57. **Vanhamme L, van den Boogaart A, and Van Huffel S.** Improved method for accurate and efficient quantification of MRS data with use of prior knowledge. *J Magn Reson* 129: 35-43, 1997.
58. **Whipp BJ and Rossiter H.** The kinetics of oxygen uptake: physiological inferences from the parameters. In A.M. Jones and D.C. Poole (Eds) *Oxygen Uptake Kinetics in Sport, Exercise and Medicine*, Routledge, London and New York, pp. 62-94, 2005.

$\dot{V}O_2$ AND [PCR] DYNAMICS AFTER PRIMING

59. **Whipp BJ, Ward SA, Lamarra N, Davis JA, and Wasserman K.** Parameters of ventilatory and gas exchange dynamics during exercise. *J Appl Physiol* 52: 1506-1513, 1982.
60. **Wilkerson DP and Jones AM.** Influence of initial metabolic rate on pulmonary O₂ uptake on-kinetics during severe intensity exercise. *Respir Physiol Neurobiol* 152: 204-219, 2006.
61. **Wilkerson DP and Jones AM.** Effects of baseline metabolic rate on pulmonary O₂ uptake on-kinetics during heavy-intensity exercise in humans. *Respir Physiol Neurobiol* 156: 203-211, 2007.
62. **Wilkerson DP, Koppo K, Barstow TJ, and Jones AM.** Effect of prior multiple-sprint exercise on pulmonary O₂ uptake kinetics following the onset of perimaximal exercise *J Appl Physiol* 97: 1227-1236, 2004.
63. **Wilson DF.** Factors affecting the rate and energetics of mitochondrial oxidative phosphorylation. *Med Sci Sports Exerc* 26: 37-43, 1994.

Priming exercise speeds pulmonary O₂ uptake kinetics during supine “work-to-work” high-intensity cycle exercise

Fred J. DiMenna,¹ Daryl P. Wilkerson,¹ Mark Burnley,² Stephen J. Bailey,¹ and Andrew M. Jones¹

¹*School of Sport and Health Sciences, St. Luke's Campus, University of Exeter, Exeter, Devon; and* ²*Department of Sport and Exercise Science, Aberystwyth University, Ceredigion, United Kingdom*

Submitted 15 September 2009; accepted in final form 27 November 2009

DiMenna FJ, Wilkerson DP, Burnley M, Bailey SJ, Jones AM. Priming exercise speeds pulmonary O₂ uptake kinetics during supine “work-to-work” high-intensity cycle exercise. *J Appl Physiol* 108: 283–292, 2010. First published December 3, 2009; doi:10.1152/jappphysiol.01047.2009.—We manipulated the baseline metabolic rate and body position to explore the effect of the interaction between recruitment of discrete sections of the muscle fiber pool and muscle O₂ delivery on pulmonary O₂ uptake (\dot{V}_{O_2}) kinetics during cycle exercise. We hypothesized that phase II \dot{V}_{O_2} kinetics (τ_p) in the transition from moderate- to severe-intensity exercise would be significantly slower in the supine than upright position because of a compromise to muscle perfusion and that a priming bout of severe-intensity exercise would return τ_p during supine exercise to τ_p during upright exercise. Eight male subjects [35 ± 13 (SD) yr] completed a series of “step” transitions to severe-intensity cycle exercise from an “unloaded” (20-W) baseline and a baseline of moderate-intensity exercise in the supine and upright body positions. τ_p was not significantly different between supine and upright exercise during transitions from a 20-W baseline to moderate- or severe-intensity exercise but was significantly greater during moderate- to severe-intensity exercise in the supine position (54 ± 19 vs. 38 ± 10 s, $P < 0.05$). Priming significantly reduced τ_p during moderate- to severe-intensity supine exercise (34 ± 9 s), returning it to a value that was not significantly different from τ_p in the upright position. This effect occurred in the absence of changes in estimated muscle fractional O₂ extraction (from the near-infrared spectroscopy-derived deoxygenated Hb concentration signal), such that the priming-induced facilitation of muscle blood flow matched increased O₂ utilization in the recruited fibers, resulting in a speeding of \dot{V}_{O_2} kinetics. These findings suggest that, during supine cycling, priming speeds \dot{V}_{O_2} kinetics by providing an increased driving pressure for O₂ diffusion in the higher-order (i.e., type II) fibers, which would be recruited in the transition from moderate- to severe-intensity exercise and are known to be especially sensitive to limitations in O₂ supply.

oxygen uptake kinetics; phase II time constant; supine exercise; work-to-work transition; priming exercise

WHEN A TRANSITION to high-intensity upright cycling is initiated from a moderate-intensity exercise baseline, the resultant “fundamental” (i.e., phase II) increase in pulmonary O₂ consumption (\dot{V}_{O_2}) is slower than when the same transition is elicited from unloaded cycling (16, 18, 55, 56). It has been proposed that this slowing of the phase II \dot{V}_{O_2} kinetics during “work-to-work” exercise can be explained, at least in part, by the population of muscle fibers contributing to power production under these circumstances (16, 18, 28, 55, 56). That is, the initiation of heavy- and severe-intensity exercise [i.e., above the gas exchange threshold (GET) and critical power, respec-

tively] from a moderate-intensity (<GET) baseline would be expected to require a greater proportional contribution to power production from fibers that are higher in the recruitment hierarchy (e.g., type II fibers) (24, 36). There is evidence to suggest that these “higher-order” fibers have slower \dot{V}_{O_2} kinetics in isolated mouse and human muscle (2, 12, 28, 45).

High-intensity cycling results in slower \dot{V}_{O_2} kinetics in the supine position because of a lengthened phase II time constant (τ_p) or a reduced amplitude of the \dot{V}_{O_2} fundamental component, with an increased amplitude of the \dot{V}_{O_2} slow component, than in the upright position (15, 25, 31). During supine exercise and any other contractile activity where the active musculature is at or above heart level, the gravitational assist to muscle blood flow is absent; therefore, perfusion pressure is reduced and the adaptation of O₂ delivery is slowed (39). Consequently, slower \dot{V}_{O_2} kinetics under these circumstances have been attributed to insufficient muscle O₂ availability (11, 15, 25, 31, 33, 38).

When high-intensity cycling is preceded by a high-intensity “priming” exercise bout, a faster overall \dot{V}_{O_2} response is observed (21, 27). Depending on the circumstances, this overall speeding of the \dot{V}_{O_2} kinetics is due to an increased amplitude of the \dot{V}_{O_2} fundamental component and a reduced amplitude of the \dot{V}_{O_2} slow component (1, 6–9, 17, 20, 32, 47–49, 57) or a shortened τ_p (14, 17, 23, 25, 33, 51). The latter situation (reduced τ_p) is typically reported only when τ_p is relatively long (e.g., when O₂ delivery is compromised) in the control condition (14, 23, 25, 33). For example, Jones et al. (25) reported that priming exercise significantly reduces τ_p during high-intensity supine cycling, thereby returning it to a value that is not significantly different from that measured during high-intensity upright cycling.

We recently reported that priming exercise does not alter the τ_p during high-intensity work-to-work cycling in the upright posture (16). This suggests that the lengthened τ_p during work-to-work exercise transitions in the upright position does not result from an O₂ delivery limitation but is, instead, related to an intrinsically slow oxidative metabolic response in the recruited higher-order muscle fibers. It is likely that these higher-order fibers would be more susceptible to interventions that decrease O₂ delivery (3, 40), such as postural alterations that reduce perfusion pressure (e.g., during cycling in the supine position). Higher-order fibers evince a greater reliance on fractional O₂ extraction to attain a given rate of oxidative metabolism (3, 40); therefore, it is possible that they would be unable to fully offset reduced perfusion pressure to prevent a further slowing of phase II \dot{V}_{O_2} kinetics during work-to-work supine cycling.

The purpose of the present study was to investigate fiber type-specific responses to reduced O₂ availability at the onset

Address for reprint requests and other correspondence: A. M. Jones, School of Sport and Health Sciences, St. Luke's Campus, Univ. of Exeter, Heavitree Rd., Exeter, Devon EX1 2LU, UK (e-mail: a.m.jones@exeter.ac.uk).

of muscular work by using the work-to-work exercise model in conjunction with cycling performed in the supine position. Specifically, by dividing severe-intensity supine cycling transitions into two discrete steps (i.e., unloaded-to-moderate and moderate-to-severe), we examined the extent to which compromised muscle perfusion might influence the $\dot{V}O_2$ response to contraction of different segments of the fiber pool. In the first part of the study, we hypothesized that τ_p would be similar in the supine and upright positions during transitions from unloaded to moderate-intensity exercise but that τ_p would be significantly longer in the supine than in the upright position during transitions from moderate- to severe intensity work-to-work exercise. In the second part of the study, subjects performed the same supine work-to-work transitions after prior severe-intensity supine cycling and hypothesized that τ_p would be reduced to a value similar to τ_p in the upright control condition after priming. To provide insight into the mechanistic bases for differences in $\dot{V}O_2$ kinetics between the conditions, we used the deoxyhemoglobin concentration ([HHb]) signal derived from near-infrared spectroscopy (NIRS) to infer the degree to which body position and priming exercise influenced muscle fractional O₂ extraction and electromyography (EMG) to assess the degree to which motor unit activation was altered by priming.

METHODS

Subjects

Eight male subjects [35 ± 13 (SD) yr old, 1.83 ± 0.08 m stature, 80.3 ± 6.7 kg body mass] volunteered and gave written informed consent to participate in this study, which had been approved by the local Research Ethics Committee. All the subjects were recreationally active and were familiar with the experimental procedures used in the present study. On test days, subjects were instructed to report to the laboratory in a rested state, having completed no strenuous exercise within the previous 24 h and having abstained from food, alcohol, and caffeine for the preceding 3 h.

Experimental Overview

All testing was completed in an air-conditioned (20–22°C) laboratory. The subjects visited the laboratory on 14 occasions over a 5-wk period to perform exercise tests on an electronically braked cycle ergometer (Lode Excalibur Sport, Groningen, The Netherlands). Testing was conducted at the same time of day (± 2 h) for each subject. On each of the first two visits, the subjects completed a ramp incremental exercise test for determination of peak $\dot{V}O_2$ ($\dot{V}O_{2\text{ peak}}$) and GET. One test was performed in the upright position and the other with the subject lying supine, and test order was alternated between subjects. To create the supine condition, the front of the ergometer was braced against the wall, with the rear of the ergometer supported on a horizontal structure specifically constructed for this purpose. Owing to this configuration, the angle formed between the front of the ergometer and the floor was 32°, and the crank shaft was positioned 45 cm above the level of the subject's back. Subjects lay supine on a mat inside a fixed structure equipped with handles that could be gripped to maintain body position, with their feet strapped securely to the pedals. On each of 12 subsequent visits, subjects completed bouts of severe-intensity exercise (at a work rate calculated to require 70% of the difference between posture-specific GET and $\dot{V}O_{2\text{ peak}}$, i.e., 70% Δ) initiated from “unloaded” (i.e., 20-W) cycling or a baseline of moderate-intensity cycling (95% of posture-specific GET). Transitions to moderate-intensity and work-to-work severe-intensity supine exercise were performed in the absence and presence of a preceding bout of severe-intensity supine cycling (70% Δ) and a rest period of 5 min. Work-to-work transitions and transitions from an unloaded baseline to severe-intensity cycling were also completed in the upright position. The experimental protocol is schematized in Fig. 1. Each of these protocols was presented to subjects three times in random order, and laboratory visits were separated by ≥ 48 h.

Experimental Procedures

The ramp incremental exercise tests consisted of 3 min of pedaling at 0 W followed by a continuous ramped increase in work rate of 30 W/min until the subject was unable to continue. The subjects cycled at 80 rpm, and saddle and handlebar heights for upright cycling and body distance relative to the crank shaft for supine cycling were recorded. The same pedal rate and settings were reproduced on subsequent tests. The $\dot{V}O_{2\text{ peak}}$ was defined as the highest 30-s mean

Fig. 1. Schematic illustrations of the 4 experimental protocols yielding the 8 experimental conditions. *Top*: data for upright moderate-intensity (UPR M), upright severe-intensity (UPR S), and upright work-to-work severe-intensity (UPR WW) cycling transitions. *Bottom*: data for supine moderate-intensity unprimed and primed (SUP MOD-U and SUP MOD-P, respectively), supine severe-intensity (SUP S), and supine work-to-work severe-intensity unprimed and primed (SUP WW-U and SUP WW-P, respectively) cycling transitions. “20 W” designates baseline “unloaded” cycling, and passive “rest” separates the prior severe-intensity and primed supine bouts.

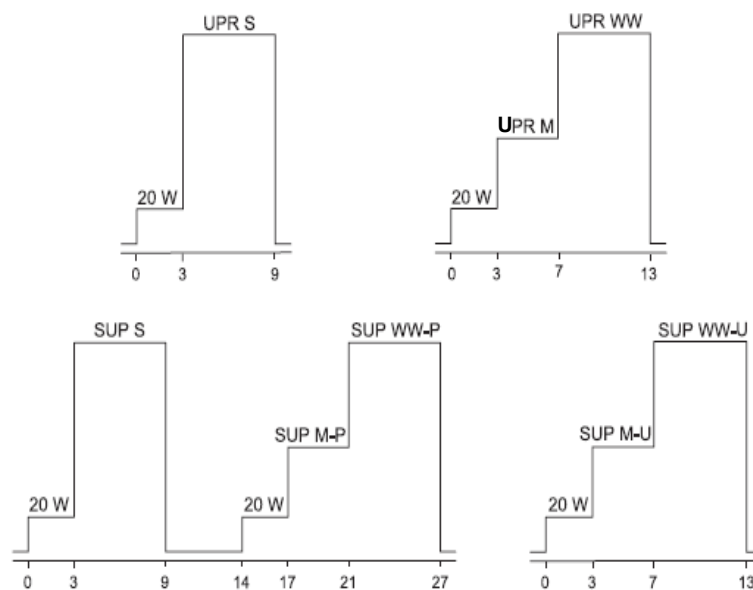

value recorded before the subject's volitional termination of the test. The GET was determined from a cluster of measurements, including 1) the first disproportionate increase in CO₂ output ($\dot{V}CO_2$) from visual inspection of individual plots of $\dot{V}CO_2$ vs. $\dot{V}O_2$, 2) an increase in $\dot{V}E/\dot{V}O_2$ (where $\dot{V}E$ is expiratory ventilation), with no increase in $\dot{V}E/\dot{V}CO_2$, and 3) an increase in end-tidal PO₂, with no fall in end-tidal PCO₂. The work rates that would require 95% of the posture-specific GET (moderate exercise) and 70% of the difference between the posture-specific GET and $\dot{V}O_{2\text{ peak}}$ (severe exercise) were estimated, with account taken of the mean response time (MRT) of the $\dot{V}O_2$ response to ramp exercise [assumed to be approximately two-thirds of the ramp rate, i.e., 20 W (52)]. These work rates were subsequently applied during the severe-intensity exercise and work-to-work transitions for the upright and supine conditions.

As outlined above, the subjects returned to the laboratory on 12 occasions to perform 1 of the following protocols: 1) 3 min of unloaded cycling at 20 W and 6 min of severe-intensity cycling in the upright position; 2) 3 min of unloaded cycling at 20 W, 4 min of moderate-intensity cycling, and 6 min of severe-intensity cycling in the upright position; 3) 3 min of unloaded cycling at 20 W, 6 min of severe-intensity cycling, 5 min of passive rest, 3 min of unloaded cycling at 20 W, 4 min of moderate-intensity cycling, and 6 min of severe-intensity cycling in the supine position; and 4) 3 min of unloaded cycling at 20 W, 4 min of moderate-intensity cycling, and 6 min of severe-intensity cycling in the supine position (Fig. 1). The $\dot{V}O_2$ responses from like-transitions were averaged before any analysis was performed to enhance the signal-to-noise ratio and improve confidence in the parameters derived from the model fits (37, 53).

During all tests, pulmonary gas exchange and ventilation were measured breath-by-breath, with subjects wearing a nose clip and breathing through a low-dead space, low-resistance mouthpiece and bidirectional digital volume sensor (Jaeger TripleV). The inspired and expired gas volume and gas concentration signals were continuously sampled at 100 Hz via a capillary line connected to the mouthpiece, the latter using paramagnetic (O₂) and infrared (CO₂) analyzers (Jaeger Oxycon Pro, Hoechberg, Germany). The gas analyzers were calibrated before each test with gases of known concentration, and the volume sensor was calibrated using a 3-liter syringe (Hans Rudolph, Kansas City, MO). Heart rate (HR) was measured every 5 s during all tests by short-range radiotelemetry (model S610, Polar Electro, Kempele, Finland). Baseline and end-exercise HR were defined as the mean HR measured over the final 90 s of cycling before each transition and the final 30 s of each exercise bout, respectively. During one of the three trials for each condition, a blood sample from a fingertip was collected into a capillary tube over the 20 s preceding any step transition in work rate and within the last 20 s of exercise and subsequently analyzed to determine blood lactate concentration ([lactate]; model 1500, Yellow Springs Instruments, Yellow Springs, OH). Blood lactate accumulation (Δ blood concentration) was calculated as the difference between blood [lactate] at end exercise and blood [lactate] before the transition.

The oxygenation status of the vastus lateralis of the right leg was monitored using a commercially available NIRS system (model NIRO 300, Hamamatsu Photonics, Hiugashi-ku, Japan). The system consisted of an emission probe that irradiates laser beams and a detection probe that is positioned several centimeters from the emission probe in an optically dense rubber holder. Four different wavelength laser diodes provided the light source (776, 826, 845, and 905 nm), and the light returning from the tissue was detected by a photomultiplier tube in the spectrometer. The intensity of incident and transmitted light was recorded continuously at 2 Hz and used to estimate concentration changes from the resting baseline for oxygenated Hb (HbO₂) and HHb/myoglobin (Mb). Therefore, the NIRS data represent a relative change based on the optical density measured in the first datum collected. The HHb concentration signal can be regarded as being essentially blood volume-insensitive during exercise (13, 22) and was, therefore, assumed to provide an estimate of changes in oxygenation status and fractional O₂ extraction in the field of interrogation (14, 22,

26). It is not possible to determine the relative contribution of Mb to the total NIRS signal, but it is generally believed to be relatively small (e.g., <10%) (50). Nevertheless, in this study, the terms [Hb_{tot}] and [HHb] should be considered to reflect the combined concentrations of total Hb and HHb + Mb, respectively.

The leg was initially cleaned and shaved around the belly of the muscle, and the probes were placed in the holder, which was secured to the skin with adhesive at 20 cm above the fibular head. The holder and wires were secured in place by an elastic bandage that was wrapped around the subject's leg. The wrap helped minimize the possibility that extraneous light could influence the signal and also ensured that the optodes did not move during exercise. Pen marks were made around the holder to enable reproduction of the placement in subsequent tests. The probe gain was set with the subject at rest in a seated position for upright exercise and in a supine position for supine exercise, with the leg extended at downstroke before the first exercise bout, and NIRS data were collected continuously throughout all bouts. The data were subsequently downloaded onto a personal computer, and the resulting text files were stored on disk for later analysis.

Neuromuscular activity of the vastus lateralis of the left leg was measured using bipolar surface EMG. The leg was initially shaved and cleaned with alcohol around the belly of the muscle, and graphite snap electrodes (Unilect 40713, Unomedical, Stonehouse, UK) were attached to the prepared area in a bipolar arrangement (40-mm interelectrode distance). A ground electrode was positioned on the rectus femoris equidistant from the active electrodes. The sites of electrode placement were chosen according to the recommendations provided in the EMG software (Mega Electronics). To secure electrodes and wires in place and minimize movement during cycling, an elastic bandage was wrapped around the subject's leg. Pen marks were made around the electrodes to enable reproduction of the placement in subsequent tests. The EMG signal was recorded using a muscle tester (model ME3000PB, Mega Electronics).

EMG measurements at a sampling frequency of 1,000 Hz were recorded throughout all exercise tests. The bipolar signal was amplified (>1-M Ω amplifier input impedance), and data were collected online in raw form and stored on a personal computer using MegaWin software (Mega Electronics). The raw EMG data were subsequently exported as an ASCII file and digitally filtered using Labview 8.2 (National Instruments, Newbury, UK). Initially, the signals were filtered with a 20-Hz high-pass second-order Butterworth filter to remove contamination from movement artifacts. The signal was then rectified and low-pass filtered at a frequency of 50 Hz to produce a linear envelope. The average integrated EMG (iEMG) was calculated for 15-s intervals throughout exercise, with these values normalized to the average measured during 15–165 s of unloaded cycling before the initial transition. Therefore, all iEMG data are presented as a percentage of the initial unloaded cycling phase. Data from repeat trials were averaged, and iEMG at *minute 2* and at end exercise were defined as the average from 120–135 s and the average over the last 15 s of exercise, respectively. Δ iEMG_{end-2} was calculated as the difference between *minute 2* and end-exercise values.

Data Analysis Procedures

The breath-by-breath $\dot{V}O_2$ data from each test were initially examined to exclude errant breaths caused by coughing, swallowing, and sighing, and those values lying >4 SDs from the local mean were removed. The breath-by-breath data were subsequently linearly interpolated to provide second-by-second values, and, for each individual, identical repetitions were time-aligned to the start of exercise and ensemble-averaged. The first 20 s of data after the onset of exercise (i.e., the phase I response) were deleted (53, 54), and a nonlinear least-square algorithm was used to fit the data. For moderate- and severe-intensity exercise, single-exponential (Eq. 1) and biexponential

(Eq. 2) models, respectively, were used to characterize the $\dot{V}O_2$ response

$$\dot{V}O_2(t) = \dot{V}O_{2\text{baseline}} + A_p[1 - e^{-(t-TD_p)/\tau_p}] \quad (1)$$

$$\dot{V}O_2(t) = \dot{V}O_{2\text{baseline}} + A_p[1 - e^{-(t-TD_p)/\tau_p}] + A_s[1 - e^{-(t-TD_s)/\tau_s}] \quad (2)$$

where $\dot{V}O_2(t)$ represents the absolute $\dot{V}O_2$ at a given time t ; $\dot{V}O_{2\text{baseline}}$ represents the mean $\dot{V}O_2$ in the baseline period; A_p , TD_p , and τ_p represent the amplitude, time delay, and time constant, respectively, describing the phase II increase in $\dot{V}O_2$ above baseline, and A_s , TD_s , and τ_s represent the amplitude of, time delay before the onset of, and time constant describing the development of, the $\dot{V}O_2$ slow component, respectively. An iterative process was used to minimize the sum of the squared errors between the fitted function and the observed values. $\dot{V}O_{2\text{baseline}}$ was defined as the mean $\dot{V}O_2$ measured over the final 90 s of cycling before each transition. The end-exercise $\dot{V}O_2$ was defined as the mean $\dot{V}O_2$ measured over the final 30 s of exercise. The absolute fundamental component amplitude (absolute A_p) was defined as the sum of $\dot{V}O_{2\text{baseline}}$ and A_p . Because the asymptotic value (A_s) of the exponential term describing the $\dot{V}O_2$ slow component may represent a higher value than is actually reached at the end of the exercise, the actual amplitude of the $\dot{V}O_2$ slow component at the end of exercise was defined as A'_s . The amplitude of the slow component was also described relative to the entire $\dot{V}O_2$ response [i.e., $A'_s/(A_p + A'_s)$] and by calculating the difference between $\dot{V}O_2$ at *minute 2* (average from 105–135 s) and end-exercise [$\Delta\dot{V}O_{2(6-2)}$]. In addition, the functional “gain” of the fundamental $\dot{V}O_2$ response (G_p) was computed by dividing A_p by $\Delta\text{work rate}$; the functional gain of the entire response (i.e., end-exercise gain) was calculated in a similar manner. We also fitted a single-exponential curve without time delay from the onset to the end of severe-intensity exercise. The MRT so derived was used to provide information on the “overall” $\dot{V}O_2$ kinetics during severe-intensity exercise, with no distinction made for the various phases of the response.

To provide information on muscle oxygenation, we also modeled the [HHb] response to exercise. The single- and biexponential models (Eqs. 1 and 2) were also used to fit the [HHb] data for moderate- and severe-intensity cycling, respectively. However, in this case, the fitting window commenced from the first data point that was 1 SD above the baseline mean after initiation of the transition. For moderate exercise, [HHb] τ and TD were summed to provide information on the overall [HHb] response dynamics ([HHb] $\tau + TD$), and the ratio of [HHb]-modeled amplitude to $\dot{V}O_2$ -modeled amplitude was calculated as an index of O₂ extraction ($\Delta[\text{HHb}]/\Delta\dot{V}O_2$). For severe exercise, [HHb] $\tau + TD$ was determined for the fundamental response phase, $\Delta[\text{HHb}]/\Delta\dot{V}O_2$ was calculated for the fundamental and overall response phases, and the [HHb] slow component at end-exercise was defined relative to the overall [HHb] response. We also fitted a single-exponential curve without time delay to the severe-intensity data from the onset to the end of exercise to provide information on the overall [HHb] kinetics, with no distinction made for the various phases of the response ([HHb] MRT). Finally, [HbO₂] responses do not approximate an exponential (12) and were, therefore, not modeled; however, we did assess total blood volume by summing the [HbO₂] and [HHb] signals to provide an estimate of [HHb_{tot}] in the area under investigation. Specifically, we determined the mean value at baseline (30 s preceding each transition), at 60-s intervals throughout exercise (15-s bins centered on each time point), and at end exercise (final 30 s) to facilitate comparisons between conditions.

Statistics

The parameters derived from the modeling of the $\dot{V}O_2$ and [HHb] data and the HR and blood [lactate] data were analyzed using paired *t*-tests or one-way repeated-measures analysis of variance with Fisher's least sig-

nificant difference tests, as appropriate, to identify the location of statistically significant differences. Significance was accepted at $P < 0.05$. Results are reported as means \pm SD.

RESULTS

The subjects' $\dot{V}O_{2\text{peak}}$ and peak work rate were significantly lower during supine than upright cycling ($51 \pm 8 \text{ ml}\cdot\text{kg}^{-1}\cdot\text{min}^{-1}$ and $389 \pm 54 \text{ W}$ for upright cycling vs. $47 \pm 6 \text{ ml}\cdot\text{kg}^{-1}\cdot\text{min}^{-1}$ and $342 \pm 39 \text{ W}$ for supine cycling, $P < 0.05$ in both cases). However, GET, which occurred at $\sim 45\%$ $\dot{V}O_{2\text{peak}}$, was not significantly different between conditions. The moderate-intensity work rates were 111 ± 16 and $103 \pm 20 \text{ W}$ for upright and supine cycling, respectively ($P < 0.05$). The severe-intensity work rates were 293 ± 41 and $258 \pm 31 \text{ W}$ for upright and supine cycling, respectively ($P < 0.05$).

Effect of Posture on $\dot{V}O_2$ Kinetics during Moderate-Intensity, Severe-Intensity, and Work-to-Work Exercise

Moderate-intensity cycling. The $\dot{V}O_2$ responses to upright and unprimed supine moderate-intensity cycling are illustrated for a representative subject in Fig. 2, and the $\dot{V}O_2$ response parameters are presented in Table 1. The phase II $\dot{V}O_2$ τ and G were not significantly different between conditions. The [HHb] $\tau + TD$ was not significantly different between conditions; however, the [HHb] amplitude and $\Delta[\text{HHb}]/\Delta\dot{V}O_2$ (Fig. 3) were significantly greater for supine cycling. The [HHb], HR, and blood [lactate] data for moderate-intensity cycling transitions are presented in Table 2.

Severe-intensity cycling. During baseline cycling, $\dot{V}O_2$ was not significantly different in the supine and upright positions. In absolute terms, end-exercise $\dot{V}O_2$ was significantly lower for supine than upright cycling; however, when expressed relative to posture-specific $\dot{V}O_{2\text{peak}}$, there was no significant difference between conditions. The phase II $\dot{V}O_2$ τ (32 ± 11 and $33 \pm 5 \text{ s}$ for upright and supine, respectively) and G and the amplitude of the $\dot{V}O_2$ slow component (0.58 ± 0.23 and $0.66 \pm 0.27 \text{ l/min}$ for upright and supine, respectively) were not significantly different between conditions. However, the MRT for $\dot{V}O_2$ was significantly greater for supine than upright exercise (64 ± 16 and $78 \pm 19 \text{ s}$ for upright and supine, respectively, $P < 0.05$).

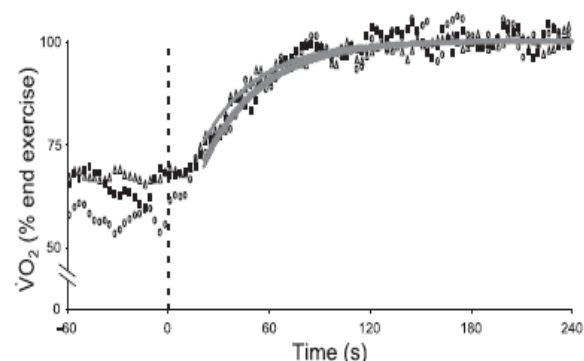

Fig. 2. Pulmonary O₂ uptake ($\dot{V}O_2$) response following the onset of moderate-intensity cycling in a representative subject. \circ , Upright condition; \blacksquare , supine unprimed condition; \blacktriangle , supine primed condition. Solid lines, phase II model fit; vertical dashed line, abrupt transition to the higher work rate. $\dot{V}O_2$ values are expressed relative to the end-exercise absolute amplitude to facilitate comparisons between upright and supine cycling. Note striking similarity in $\dot{V}O_2$ kinetics, despite the supine posture and prior high-intensity priming.

Table 1. O₂ uptake kinetics during moderate-intensity upright, supine unprimed, and supine primed cycling

	Moderate-Intensity Cycling		
	Upright	Supine	
		Unprimed	Primed
Baseline O ₂ uptake, l/min	0.90 ± 0.99	1.03 ± 0.52*	1.20 ± 0.85*†
Phase II τ, s	26 ± 7	35 ± 15	30 ± 12
Phase II amplitude, l/min	0.81 ± 0.20	0.67 ± 0.18*	0.69 ± 0.16*
Phase II gain, ml·min ⁻¹ ·W ⁻¹	8.8 ± 0.8	8.0 ± 0.9	8.3 ± 0.6
End-exercise O ₂ uptake			
l/min	1.71 ± 0.25	1.70 ± 0.20	1.88 ± 0.21†
%peak O ₂ uptake	42 ± 6	45 ± 6	50 ± 7*†

Values are means ± SD. τ, time constant. *Significantly different from upright (P < 0.05). †Significantly different from unprimed (P < 0.05).

Blood [lactate] and HR were similar between the upright and supine conditions. The [HHb] τ + TD (14 ± 2 and 15 ± 4 s for upright and supine, respectively) and the [HHb] amplitude [259 ± 119 and 291 ± 106 arbitrary units (AU) for upright and supine, respectively] were not significantly different between conditions; however, Δ[HHb]/Δ $\dot{V}O_2$ was significantly greater for supine cycling (105 ± 52 and 158 ± 76 AU·l·min⁻¹ for upright and supine, respectively, P < 0.05).

Work-to-work (moderate- to severe-intensity) cycling. The $\dot{V}O_2$ responses to upright and unprimed supine work-to-work cycling are illustrated for a representative subject in Fig. 4, and the $\dot{V}O_2$ response parameters are presented in Table 3. The phase II $\dot{V}O_2$ τ was significantly longer for supine cycling (38 ± 10 vs. 54 ±

Table 2. Blood [lactate], HR dynamics, and HHb kinetics during moderate-intensity upright, supine unprimed, and supine primed cycling

	Moderate-Intensity Cycling		
	Upright	Supine	
		Unprimed	Primed
Blood [lactate], mM			
Baseline	0.8 ± 0.4	0.9 ± 0.6	5.4 ± 2.5*†
End-exercise	1.0 ± 0.5	1.3 ± 0.6	4.6 ± 2.2*†
Δ	0.2 ± 0.3	0.3 ± 0.4	-0.8 ± 0.9*†
HR, beats/min			
Baseline	80 ± 11	83 ± 9	103 ± 14*†
End-exercise	103 ± 13	103 ± 11	120 ± 17*†
[HHb]			
τ + TD, s	25 ± 9	21 ± 4	21 ± 6
Amplitude, AU	99 ± 58	141 ± 95*	170 ± 105*
Δ[HHb]/ΔO ₂ [vφ]2[ρ] uptake, AU·l·min ⁻¹	124 ± 58	206 ± 107*	238 ± 118*

Values are means ± SD. [Lactate], lactate concentration; HR, heart rate; [HHb], deoxygenated Hb; TD, time delay; AU, arbitrary units. *Significantly different from upright (P < 0.05). †Significantly different from unprimed (P < 0.05).

19 s, P < 0.05), but G was not significantly different between conditions. In absolute terms, the $\dot{V}O_2$ slow component was less during supine work-to-work cycling; however, when expressed in relative terms, there was no significant difference between conditions. The MRT for $\dot{V}O_2$ was significantly greater for supine than upright exercise. The fundamental [HHb] τ + TD and the Δ[HHb]/Δ $\dot{V}O_2$ during the fundamental and overall response phases (Fig. 3) were not significantly different for upright and supine work-to-work cycling; however, the [HHb] MRT was significantly shorter for the supine transition, and the [HHb] slow component was significantly reduced. The [HHb], HR, and blood [lactate] data for severe work-to-work cycling transitions are presented in Table 4.

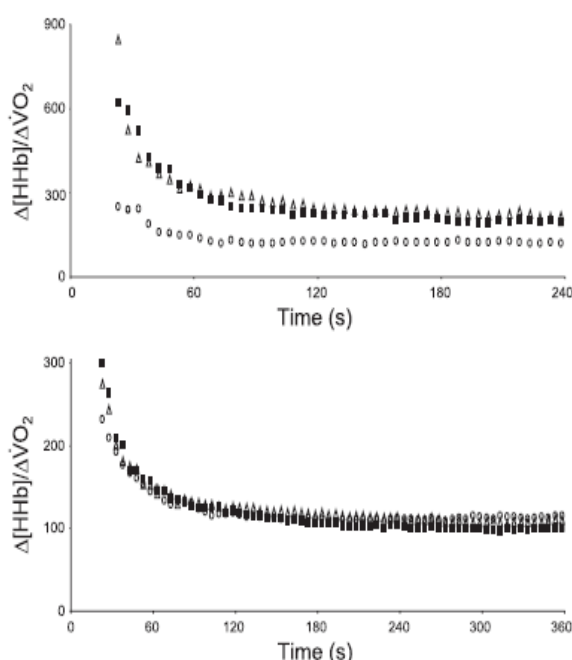

Fig. 3. Group mean index of O₂ extraction (Δ[HHb]/Δ $\dot{V}O_2$, where [HHb] is deoxygenated Hb) during moderate-intensity (top) and work-to-work severe-intensity (bottom) cycling transitions. ○, Upright condition; ■, supine unprimed condition; △, supine primed condition. Note higher values indicative of greater fractional O₂ extraction throughout the moderate-intensity supine cycling bouts and also the lack of similar elevation for work-to-work severe-intensity supine cycling. Data beginning 20 s after transition are shown to eliminate Δ[HHb]/Δ $\dot{V}O_2$ values based on pulmonary $\dot{V}O_2$ that does not accurately reflect muscle O₂ consumption (i.e., the “cardiodynamic” phase).

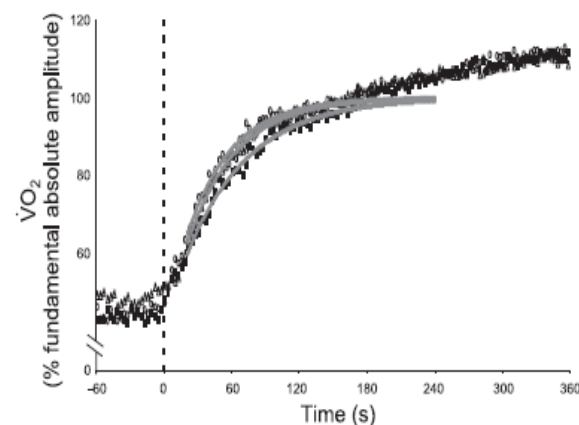

Fig. 4. Pulmonary $\dot{V}O_2$ response following the onset of work-to-work cycling (i.e., severe-intensity cycling initiated from a moderate-intensity baseline) in a representative subject. ○, Upright condition; ■, supine unprimed condition; △, supine primed condition. Solid lines, phase II model fit; vertical dashed line, abrupt transition to the higher work rate. $\dot{V}O_2$ values are expressed relative to the fundamental absolute amplitude to facilitate comparisons between upright and supine cycling. Note marked slowing of phase II $\dot{V}O_2$ kinetics during supine work-to-work cycling in the unprimed, but not primed, state.

Table 3. O₂ uptake kinetics during work-to-work severe-intensity upright, supine unprimed, and supine primed cycling

	Work-to-Work Severe-Intensity Cycling		
	Upright	Supine	
		Unprimed	Primed
Baseline O ₂ uptake, l/min	1.72 ± 0.21	1.70 ± 0.18	1.88 ± 0.21*†
Phase II τ, s	38 ± 10	54 ± 19*	34 ± 9†
Phase II amplitude, l/min	1.77 ± 0.32	1.61 ± 0.30	1.40 ± 0.33*†
Phase II gain, ml·min ⁻¹ ·W ⁻¹	9.8 ± 1.3	10.4 ± 1.1	9.0 ± 1.0†
Fundamental absolute amplitude, l/min	3.49 ± 0.42	3.31 ± 0.36*	3.28 ± 0.31*
O ₂ uptake slow component TD, s	114 ± 37	146 ± 38	108 ± 40†
O ₂ uptake slow component amplitude, l/min	0.49 ± 0.16	0.32 ± 0.12*	0.36 ± 0.16
O ₂ uptake slow component relative amplitude, %	22 ± 8	17 ± 7	21 ± 10
ΔO ₂ uptake between minute 6 and minute 2, l/min	0.48 ± 0.14	0.47 ± 0.12	0.32 ± 0.13*†
O ₂ uptake MRT, s	71 ± 18	84 ± 20*	69 ± 18†
End-exercise O ₂ uptake l/min	3.95 ± 0.38	3.60 ± 0.30*	3.62 ± 0.31*
%peak O ₂ uptake	97 ± 5	96 ± 3	96 ± 6
End-exercise gain, ml·min ⁻¹ ·W ⁻¹	12.4 ± 1.6	12.4 ± 0.8	11.2 ± 0.7†

Values are means ± SD. MRT, mean response time. *Significantly different from upright (*P* < 0.05). †Significantly different from unprimed (*P* < 0.05).

Effect of Priming on Moderate and Work-to-Work Cycling Exercise in the Supine Position

The $\dot{V}O_2$ responses to unprimed and primed moderate-intensity and work-to-work supine cycling are illustrated for a representative subject in Figs. 2 and 4, respectively. Group mean $\dot{V}O_2$ response parameters after priming are presented in Tables 1 and 3, and group mean [HHb], HR, and blood

Table 4. Blood [lactate], HR dynamics, and HHb kinetics during work-to-work severe-intensity upright, supine unprimed, and supine primed cycling

	Work-to-Work Severe-Intensity Cycling		
	Upright	Supine	
		Unprimed	Primed
Blood [lactate], mM			
Baseline	1.0 ± 0.5	1.3 ± 0.6	4.6 ± 2.2*†
End-exercise	6.2 ± 1.1	5.9 ± 1.6	7.7 ± 3.0†
Δ	5.3 ± 0.9	4.6 ± 1.4	3.1 ± 1.2*†
HR, beats/min			
Baseline	103 ± 12	102 ± 10	119 ± 17*†
End-exercise	163 ± 16	156 ± 17*	165 ± 19†
[HHb]			
Fundamental [HHb] τ + TD, s	19 ± 5	22 ± 12	20 ± 9
Fundamental [HHb] amplitude, AU	186 ± 80	154 ± 65	167 ± 53
Fundamental Δ[HHb]/ΔO ₂ uptake, l/min	112 ± 63	100 ± 52	125 ± 44
[HHb] slow component, %	27 ± 9	18 ± 6*	11 ± 10*
[HHb] MRT, s	39 ± 18	27 ± 10*	26 ± 14*
Overall Δ[HHb]/ΔO ₂ uptake, AU·l·min ⁻¹	113 ± 53	100 ± 41	109 ± 34

Values are means ± SD. *Significantly different from upright (*P* < 0.05). †Significantly different from unprimed (*P* < 0.05).

[lactate] data after priming are presented in Tables 2 and 4. Baseline $\dot{V}O_2$, HR, and blood [lactate] were significantly elevated before moderate-intensity supine cycling after priming, as was [Hb_{tot}] (Fig. 5), and all these elevations were present at end exercise. Consequently, baseline $\dot{V}O_2$, HR, blood [lactate], and [Hb_{tot}] were significantly elevated before the work-to-work severe-intensity cycling transition.

The phase II $\dot{V}O_2$ τ, amplitude, and G were not significantly different during moderate-intensity supine cycling after priming. However, during severe-intensity work-to-work cycling, phase II $\dot{V}O_2$ τ was significantly reduced (54 ± 19 vs. 34 ± 9 s, *P* < 0.05). Furthermore, after priming, τ_p was not significantly different from the upright work-to-work control condition. The extent of the reduction of τ_p for supine work-to-work cycling after priming was significantly correlated with the difference in τ_p between the upright and unprimed supine work-to-work values (*r* = 0.88, *P* < 0.01). Similar to τ_p, $\dot{V}O_2$ MRT was significantly shorter and was not significantly different from the upright unprimed control condition for work-to-work supine cycling after priming. No significant difference in $\dot{V}O_2$ fundamental absolute or slow component (absolute or relative) amplitude was observed, although Δ $\dot{V}O_{2(6-2)}$ was significantly reduced. There were no significant differences in fundamental [HHb] τ + TD, fundamental and overall Δ[HHb]/Δ $\dot{V}O_2$, or [HHb] MRT for work-to-work severe-intensity supine cycling after priming. However, the [HHb] slow component tended to be lower across the group (*P* = 0.07) and was completely eliminated in three subjects during the primed work-to-work supine transition.

For unprimed and primed moderate-intensity supine cycling, the mean iEMG at the end of exercise was not significantly different from τ_p at minute 2, and ΔiEMG_(end-2) was not affected by priming. In contrast, for unprimed and primed work-to-work supine cycling, the mean iEMG at the end of exercise was significantly greater than that measured at minute 2. The ΔiEMG_(end-2) for unprimed and primed work-to-work cycling was not significantly affected by priming. The group mean iEMG responses at minute 2 and end exercise for moderate-intensity and work-to-work severe-intensity supine cycling in the unprimed and primed states are depicted in Fig. 6.

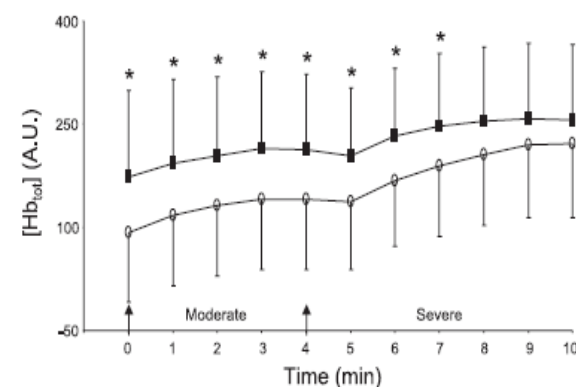

Fig. 5. Total Hb concentration ([Hb]_{tot}) at 60-s intervals during moderate-intensity and work-to-work supine cycling in the unprimed (○) and primed (■) states. Arrows, abrupt transitions to the higher work rates. AU, arbitrary units. Values are means ± SD. *Significantly different from unprimed (*P* < 0.05). A significant elevation indicative of hyperemia is present throughout the 4-min moderate-intensity bout and for the first 3 min of the 6-min severe-intensity bout after priming.

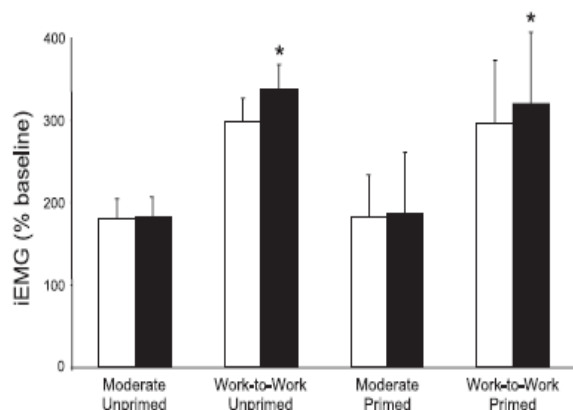

Fig. 6. Integrated EMG (iEMG) response during moderate-intensity and work-to-work severe-intensity unprimed and primed supine cycling. Percentage of baseline iEMG was measured at *minute 2* (open bars) and end exercise (solid bars) for each of the 4 conditions. Values are means \pm SD. *Significantly different from *minute 2* within condition ($P < 0.05$). Note significant increase in iEMG from *minute 2* to end exercise that occurred exclusively during work-to-work cycling and was not altered by priming.

DISCUSSION

The principal finding of this investigation was that the characteristic slowing of phase II $\dot{V}O_2$ kinetics that is observed for severe-intensity upright cycling transitions initiated from an elevated baseline was amplified when the same relative intensity transition was performed in the supine position. Specifically, unlike moderate-intensity supine cycling, where muscle fractional O₂ extraction was increased to preserve $\dot{V}O_2$ kinetics, O₂ extraction during work-to-work supine cycling was unchanged compared with the upright control condition and the $\dot{V}O_2$ τ_p was thus lengthened by $\sim 50\%$. However, the performance of prior high-intensity exercise shortened τ_p during supine work-to-work severe-intensity cycling, so that it was not significantly different from τ_p in the upright position.

Effect of Posture on $\dot{V}O_2$ Kinetics During Moderate-Intensity and Work-to-Work Cycle Exercise

Consistent with our hypothesis, τ_p was not significantly different for supine compared with upright moderate-intensity cycling. However, NIRS data indicated a marked difference in the degree of Hb/Mb desaturation that was required to maintain an uncompromised $\dot{V}O_2$ response in the supine position. Specifically, $\Delta[\text{HHb}]/\Delta\dot{V}O_2$ was significantly greater during moderate-intensity supine than moderate-intensity upright cycling, which indicates that fractional O₂ extraction was enhanced throughout the bout (Fig. 3). The gravitational assist to muscle blood flow is absent during supine exercise, and MacDonald et al. (39) showed slower kinetics of femoral artery blood flow during low-intensity knee extension/flexion exercise in the supine than upright position. Therefore, it is likely that increased O₂ extraction during moderate-intensity supine cycling was necessary to compensate for a blunted circulatory response.

Also consistent with our hypothesis, τ_p was significantly lengthened for severe-intensity supine cycling transitions initiated from a moderate-intensity baseline, in relation to transitions to severe-intensity supine cycling from an unloaded baseline (slowed by $\sim 65\%$) and severe-intensity upright cy-

cling from a moderate-intensity baseline (slowed by $\sim 50\%$). Estimated muscle fractional O₂ extraction (as $\Delta[\text{HHb}]/\Delta\dot{V}O_2$) was not different between work-to-work transitions in the supine and upright positions, but faster [HHb] kinetics (a reduced [HHb] slow component and shortened [HHb] MRT) were apparent for supine exercise. These effects (a lengthened $\dot{V}O_2$ τ_p and faster [HHb] time course with no change in the amplitude of estimated O₂ extraction) during supine compared with upright work-to-work exercise are in contrast to our observations during moderate-intensity exercise (see above). These data suggest that muscle O₂ extraction could not be increased sufficiently to compensate for reduced muscle blood flow during work-to-work exercise in the supine position, resulting in slower phase II $\dot{V}O_2$ kinetics. This is consistent with what would be predicted for the population of higher-order muscle fibers that would be expected to predominantly contribute to power production across the work-to-work transition (24, 36). These fibers are known to exhibit a faster and more pronounced decrease in microvascular Po₂ at the onset of contractions, suggesting a greater reliance on fractional O₂ extraction to maintain a given oxidative flux (3, 40).

Effect of Priming on Moderate-Intensity and Work-to-Work Cycle Exercise in the Supine Position

Consistent with our hypothesis, the performance of prior high-intensity exercise resulted in a significant speeding of phase II $\dot{V}O_2$ kinetics during work-to-work, but not moderate-intensity, supine cycling. Specifically, after priming, τ_p during work-to-work supine cycling was reduced by $\sim 33\%$ and was no longer significantly different from the upright work-to-work value. Furthermore, the extent of the reduction in τ_p with priming was significantly correlated with the difference in τ_p between the upright and supine conditions. Collectively, these findings suggest that priming counteracted the adverse effects of the supine body posture during work-to-work cycling.

It is well documented that prior high-intensity exercise that results in residual metabolic acidosis facilitates convective and diffusive components of muscle O₂ delivery, increases muscle oxidative enzyme activity, and alters motor unit recruitment profiles during subsequent exercise (1, 6, 10, 14, 16, 20, 25, 27, 34, 47, 48, 51). Collectively, these changes accelerate the overall $\dot{V}O_2$ kinetics during subsequent high-intensity exercise (21, 27), due predominantly to a marked reduction of the $\dot{V}O_2$ slow component with increased fundamental phase absolute amplitude, but no change in τ_p (1, 6–9, 20, 27, 32, 47–49, 57). We recently showed that priming exercise results in these same effects when severe-intensity upright cycle exercise is initiated from a moderate-intensity baseline (16). However, in other circumstances where τ_p is rather long in the control condition (i.e., more than ~ 30 – 35 s), a reduction of τ_p has been reported (14, 23, 25, 33). The priming effect that we observed for supine work-to-work cycling (reduced τ_p with unchanged fundamental and slow component amplitudes) in the present study is different from the effect we reported previously for upright work-to-work cycling (altered fundamental and slow component amplitudes with unchanged τ_p) (16). This difference is consistent with the findings of Jones et al. (25), who reported that, during upright cycling, priming altered the amplitudes of the fundamental and slow components without changing τ_p , whereas during supine cycling, priming reduced τ_p without

changing the response phase amplitudes. Whether priming exercise alters the response phase amplitudes or the τ_p during subsequent exercise, therefore, appears to be related to the adequacy of O₂ delivery relative to metabolic rate in the control condition.

A model that explains why τ_p might or might not be influenced by altered O₂ delivery has been advanced by Poole et al. (43, 44). In this model, it is proposed that there is an “O₂ delivery-independent” zone within which changing O₂ delivery will not substantially impact τ_p (e.g., during moderate-intensity exercise in healthy young subjects) and, beyond the so-called “tipping point,” an “O₂ delivery-dependent” zone within which enhancing or reducing O₂ delivery will shorten or lengthen the τ_p , respectively (43, 44). Application of this model to the present study might suggest that the muscle fibers predominantly involved in moderate-intensity cycling lie to the right of the tipping point, whereas the fibers involved in a moderate-to-severe work-to-work transition operate at or close to the tipping point, with the supine position placing them firmly in the O₂ delivery-dependent zone.

We observed a significant difference between iEMG at *minute 2* and end exercise during work-to-work supine cycling in the unprimed and primed states (Fig. 6), and the magnitude of this difference [i.e., $\Delta iEMG_{(end-2)}$] was unaffected by priming. These results contrast with those that we reported previously for primed work-to-work cycling in the upright position, which was characterized by a significant reduction of $\Delta iEMG_{(end-2)}$, such that the end-exercise value was no longer different from the *minute 2* value after priming (16). One explanation for the increased $\dot{V}O_2$ fundamental component amplitude and reduced $\dot{V}O_2$ slow component amplitude after priming in the upright position is that motor unit recruitment is increased during the early stages of high-intensity exercise, such that the requirement for additional fiber activation as exercise proceeds and the associated $\dot{V}O_2$ cost of that activation are reduced (1, 6, 10). The iEMG results in the present study suggest that the characteristic slow component reduction that is present under “normal” circumstances after priming might be absent in the supine posture, because fiber activation is not altered in a similar manner. Why the effect of prior exercise on subsequent fiber activation would be different for supine compared with upright cycling is unclear but might be linked to the unusual nature of cycling in the supine position. In contrast to our previous study (25) in which subjects exercised at the same absolute work rate in the supine and upright positions, the subjects in the present study cycled at the same relative intensity (70% Δ) in the supine and upright positions. This was done to better match the physiological demands of exercise in the different postures. However, a lack of familiarity for most subjects with this form of exercise could mandate an altered fiber activation pattern as exercise proceeds that is independent of favorable metabolic alterations induced by priming.

It is also possible that, despite increased O₂ availability at the onset of primed cycling, the supine posture alters perfusion sufficiently to accelerate removal of this effect as the bout proceeds. Previous research indicates that, for upright cycling, the characteristic prior-exercise effect declines in a time-dependent manner but is preserved for ≥ 20 –30 min (1, 8). Although it has yet to be established which specific residual physiological alteration(s) underpins this phenomenon, it is interesting to note that the increase in $[Hb_{tot}]$ that we observed at the onset of primed work-to-work supine cycling in the

present study (presumably reflecting hyperemia) was abolished after 3 min of exercise (Fig. 5). It is well established that O₂ availability exerts a profound influence on motor unit recruitment (41, 42), particularly in high-threshold motor units comprising fast-twitch fibers, which have been implicated in the development of the $\dot{V}O_2$ slow component (2, 35, 36, 45, 46). Therefore, it is possible that, despite facilitation of the initial $\dot{V}O_2$ response during supine exercise after priming, the elevated tissue oxygenation is relatively short-lived, resulting in a more rapid development of fatigue and a continued drive for motor unit recruitment similar to that observed in the unprimed state.

Although priming did not reduce the $\dot{V}O_2$ slow component in the present study, it did shorten the time delay before its emergence. Jones et al. (25) also reported a significant reduction in the slow component time delay for primed supine cycling with no similar effect for primed upright cycling. The $\dot{V}O_2$ slow component time delay is not altered by priming during upright cycle exercise (6, 7, 9, 16, 17, 20, 49). The reason for this disparity is unclear. However, if the $\dot{V}O_2$ slow component is related, at least in part, to the protracted response profiles of initially recruited fibers with extremely slow $\dot{V}O_2$ kinetics (56), a reduced time delay during supine exercise might reflect an accelerated phase II $\dot{V}O_2$ response in these fibers. We previously speculated that such a speeding might be indistinguishable from reciprocal changes in the amplitudes of the $\dot{V}O_2$ fundamental and slow components during upright cycling (17).

Other than an elevated baseline and end-exercise $\dot{V}O_2$, we observed no significant differences in $\dot{V}O_2$ kinetics during moderate-intensity supine cycling after priming. Specifically, even though HR, blood [lactate], and $[Hb_{tot}]$ were elevated at the onset of and throughout the moderate-intensity primed supine bout, τ_p was not altered. Prior research indicates that moderate-intensity cycling in the upright position is unaffected by moderate- or high-intensity prior exercise (6, 19, 21; cf. Ref. 23). Therefore, given that the supine posture did not compromise $\dot{V}O_2$ kinetics for moderate-intensity cycling in the present study (i.e., τ_p was similar in the supine and upright positions), this result is not surprising. Moreover, $\Delta[Hb]/\Delta\dot{V}O_2$ was unaffected during moderate-intensity supine cycling after priming, which supports the notion that O₂ extraction by the involved muscle fibers had already increased sufficiently to counteract the supine posture. In this regard, it is interesting to note that priming also did not enhance $\Delta[Hb]/\Delta\dot{V}O_2$ during work-to-work supine cycling (Fig. 3). This indicates that the speeding of $\dot{V}O_2$ kinetics after priming during supine work-to-work exercise was related to an increased bulk muscle blood flow and/or better local matching of perfusion to metabolic rate, rather than any changes in muscle fractional O₂ extraction, which might have been close to maximal in the control condition.

Methodological Considerations

It should be cautioned that our NIRS measurements were made at only one site (the vastus lateralis), and we cannot be certain that the conclusions reached from the $[HHb]$ response measured at that site hold true for other regions of the quadriceps. Indeed, there is some evidence that the vastus lateralis has a higher fraction of type II fibers and lower blood flow than these other regions (29). Recent studies showed that the pattern

of quadriceps muscle deoxygenation following the onset of heavy exercise displays significant intersite heterogeneity (30) and that this heterogeneity is reduced after a priming bout of heavy exercise (48). Although the reduced heterogeneity of muscle deoxygenation following priming was not correlated with changes in $\dot{V}O_2$ kinetics (i.e., reduced $\dot{V}O_2$ slow component) during upright cycle exercise (48), it remains to be established whether a more homogenous distribution of blood flow might be, in part, responsible for the faster phase II $\dot{V}O_2$ kinetics observed after priming in the supine position (25; present study).

Boone et al. (4) recently proposed that, because of the existence of an additional amount of unmeasured (negative) internal work, the measured $\dot{V}O_2$ at very low baseline work rates is higher than the value that would be expected from backextrapolation of the $\dot{V}O_2$ response to moderate-intensity exercise. The authors argued that this could influence $\dot{V}O_2$ kinetics and might, in part, explain the greater functional gain of the $\dot{V}O_2$ response that is measured during cycling when the baseline work rate is above compared with below ~ 50 W (5, 56). However, although it is possible that the influence of internal work could contribute to the differences in the $\dot{V}O_2$ gain between moderate-intensity and work-to-work exercise in the present study, it should be stressed that this would not influence our within-condition comparisons (i.e., the effects of body position and priming on $\dot{V}O_2$ kinetics during moderate-intensity or work-to-work severe-intensity transitions). It is also important to note that muscle phosphocreatine kinetics, which closely reflect muscle $\dot{V}O_2$ kinetics (43), provide evidence of slower dynamics and an increased gain for transitions from moderate- to heavy-intensity exercise compared with transitions from rest to moderate-intensity exercise, where no similar internal work disparity would be expected (28).

In conclusion, we have shown notable differences in the capacities for the recruited fractions of the motor unit pool to adapt to altered muscle perfusion during supine cycle exercise. Specifically, by dividing transitions to severe-intensity cycling into two discrete steps, we attempted to isolate the response characteristics of fibers that are positioned “lower” and “higher” in the recruitment hierarchy. During moderate-intensity supine exercise, the results indicate that muscle fractional O₂ extraction was increased in the recruited fibers, such that $\dot{V}O_2$ kinetics were preserved. Conversely, during transitions from moderate- to severe-intensity work-to-work exercise, which would obligate the recruitment of a different population of fibers situated higher in the recruitment order, muscle fractional O₂ extraction was unchanged and $\dot{V}O_2$ kinetics were markedly slowed. The fiber type specificity in the susceptibility to reduced perfusion pressure suggested by our results is consistent with previous findings of a faster and more pronounced fall in microvascular P_{O₂} at the onset of contractions (reflecting a greater reliance on fractional O₂ extraction) in fast-twitch muscle (3, 40). Furthermore, priming exercise did not alter $\dot{V}O_2$ kinetics during moderate-intensity supine cycling but did accelerate the $\dot{V}O_2$ response during work-to-work transitions in the supine position, restoring τ_p to the value that was observed during upright work-to-work exercise. This latter effect occurred in the absence of increased muscle fractional O₂ extraction, indicating that the priming-induced facilitation of blood flow matched increased O₂ utilization in the involved fibers and resulted in faster $\dot{V}O_2$ kinetics. Collectively, these

findings suggest that, during supine cycling, priming speeds $\dot{V}O_2$ kinetics by enhancing perfusion in the higher-order (i.e., type II) fibers, which are known to be especially sensitive to limitations in O₂ supply.

DISCLOSURES

No conflicts of interest are declared by the author(s).

REFERENCES

- Bailey SJ, Vanhatalo A, Wilkerson DP, DiMenna FJ, Jones AM. Optimizing the “priming” effect: influence of prior exercise and recovery duration on O₂ uptake kinetics and severe-intensity exercise tolerance. *J Appl Physiol* 107: 1743–1756, 2009.
- Barstow TJ, Jones AM, Nguyen H, Casaburi R. Influence of muscle fiber type and pedal frequency on oxygen uptake kinetics of heavy exercise. *J Appl Physiol* 81: 1642–1650, 1996.
- Behnke BJ, McDonough P, Padilla DJ, Musch TI, Poole DC. Oxygen exchange profile in rat muscles of contrasting fibre types. *J Physiol* 549: 597–605, 2003.
- Boone J, Koppo K, Bouckaert J. The $\dot{V}O_2$ response to submaximal ramp cycle exercise: influence of ramp slope and training status. *Respir Physiol Neurobiol* 161: 291–297, 2008.
- Brittain CJ, Rossiter HB, Kowalchuk JM, Whipp BJ. Effect of prior metabolic rate on the kinetics of oxygen uptake during moderate-intensity exercise. *Eur J Appl Physiol* 86: 125–134, 2001.
- Burnley M, Doust JH, Ball D, Jones AM. Effects of prior heavy exercise on $\dot{V}O_2$ kinetics during heavy exercise are related to changes in muscle activity. *J Appl Physiol* 93: 167–174, 2002.
- Burnley M, Doust JH, Carter H, Jones AM. Effects of prior exercise and recovery duration on oxygen uptake kinetics during heavy exercise in humans. *Exp Physiol* 86: 417–425, 2001.
- Burnley M, Doust JH, Jones AM. Time required for the restoration of normal heavy exercise $\dot{V}O_2$ kinetics following prior heavy exercise. *J Appl Physiol* 101: 1320–1327, 2006.
- Burnley M, Jones AM, Carter H, Doust JH. Effects of prior heavy exercise on phase II pulmonary oxygen uptake kinetics during heavy exercise. *J Appl Physiol* 89: 1387–1396, 2000.
- Burnley M, Koppo K, Jones AM. “Priming exercise” and $\dot{V}O_2$ kinetics. In: *Oxygen Uptake Kinetics in Sport, Exercise and Medicine*, edited by Jones AM and Poole DC. New York: Routledge, 2005, p. 230–260.
- Cerretelli P, Shindell D, Pendergast DP, di Prampero PE, Rennie DW. Oxygen uptake transients at the onset and offset of arm and leg work. *Respir Physiol* 30: 81–97, 1977.
- Crow MT, Kushmerick MJ. Chemical energetics of slow- and fast-twitch muscles of the mouse. *J Gen Physiol* 79: 147–166, 1982.
- De Blasi RA, Cope M, Elwell C, Safoue F, Ferrari M. Noninvasive measurement of human forearm oxygen consumption by near infrared spectroscopy. *Eur J Appl Physiol Occup Physiol* 67: 20–25, 1993.
- DeLorey DS, Kowalchuk JM, Heenan AP, duManoir GR, Paterson DH. Prior exercise speeds pulmonary O₂ uptake kinetics by increases in both local muscle O₂ availability and O₂ utilization. *J Appl Physiol* 103: 771–778, 2007.
- Denis R, Perrey S. Influence of posture on pulmonary O₂ uptake kinetics, muscle deoxygenation and myoelectrical activity during heavy-intensity exercise. *J Sports Sci Med* 5: 254–265, 2006.
- DiMenna FJ, Wilkerson DP, Burnley M, Jones AM. Influence of priming exercise on pulmonary O₂ uptake kinetics during transitions to high-intensity exercise from an elevated baseline. *J Appl Physiol* 105: 538–546, 2008.
- DiMenna FJ, Wilkerson DP, Burnley M, Bailey SJ, Jones AM. Influence of priming exercise on pulmonary O₂ uptake kinetics during transitions to high-intensity exercise at extreme pedal rates. *J Appl Physiol* 106: 432–442, 2009.
- DiMenna FJ, Wilkerson DP, Burnley M, Bailey SJ, Jones AM. Influence of extreme pedal rates on pulmonary O₂ uptake kinetics during transitions to high-intensity exercise from an elevated baseline. *Respir Physiol Neurobiol* 169: 16–23, 2009.
- Ferreira LF, Lutjemeier BJ, Townsend DK, Barstow TJ. Dynamics of skeletal muscle oxygenation during sequential bouts of moderate exercise. *Exp Physiol* 90: 393–401, 2005.

20. Fukuba Y, Hayashi N, Koga S, Yoshida T. $\dot{V}O_2$ kinetics in heavy exercise is not altered by prior exercise with a different muscle group. *J Appl Physiol* 92: 2467–2474, 2002.
21. Gerbino A, Ward SA, Whipp BJ. Effects of prior exercise on pulmonary gas-exchange kinetics during high-intensity exercise in humans. *J Appl Physiol* 80: 99–107, 1996.
22. Grassi B, Pogliaghi S, Rampichini S, Quaresima V, Ferrari M, Marconi C, Cerretelli P. Muscle oxygenation and pulmonary gas exchange kinetics during cycle exercise on-transitions in humans. *J Appl Physiol* 95: 149–158, 2003.
23. Gurd BJ, Scheuermann BW, Paterson DH, Kowalchuk JM. Prior heavy-intensity exercise speeds $\dot{V}O_2$ kinetics during moderate-intensity exercise in young adults. *J Appl Physiol* 98: 1371–1378, 2005.
24. Henneman E, Mendell LM. Functional organisation of motoneuron pool and its inputs. In: *Handbook of Physiology. The Nervous System*. Bethesda, MD: Am. Physiol. Soc., 1981, sect. 1, vol. II, pt. 1, p. 423–507.
25. Jones AM, Berger NJ, Wilkerson DP, Roberts CL. Effects of “priming” exercise on pulmonary O₂ uptake and muscle deoxygenation kinetics during heavy-intensity cycle exercise in the supine and upright positions. *J Appl Physiol* 101: 1432–1441, 2006.
26. Jones AM, Fulford J, Wilkerson DP. Influence of prior exercise on muscle [phosphorylcreatine] and deoxygenation kinetics during high-intensity exercise in men. *Exp Physiol* 93: 468–478, 2008.
27. Jones AM, Koppo K, Burnley M. Effects of prior exercise on metabolic and gas exchange responses to exercise. *Sports Med* 33: 949–971, 2003.
28. Jones AM, Wilkerson DP, Fulford J. Muscle [phosphocreatine] dynamics following the onset of exercise in humans: the influence of baseline work-rate. *J Physiol* 586: 889–898, 2008.
29. Kalliokoski KK, Scheede-Bergdahl C, Kjaer M, Boushel R. Muscle perfusion and metabolic heterogeneity: insights from noninvasive imaging techniques. *Exerc Sport Sci Rev* 34: 164–170, 2006.
30. Koga S, Poole DC, Ferreira LF, Whipp BJ, Kondo N, Saitoh T, Ohmae E, Barstow TJ. Spatial heterogeneity of quadriceps muscle deoxygenation kinetics during cycle exercise. *J Appl Physiol* 103: 2049–2056, 2007.
31. Koga S, Shiojiri T, Shibasaki M, Kondo N, Fukuba Y, Barstow TJ. Kinetics of oxygen uptake during supine and heavy exercise. *J Appl Physiol* 87: 253–260, 1999.
32. Koppo K, Bouckaert J. The effect of prior high-intensity cycling exercise on the $\dot{V}O_2$ kinetics during high-intensity cycling exercise is situated at the additional slow component. *Int J Sports Med* 22: 21–26, 2001.
33. Koppo K, Bouckaert J. Prior arm exercise speeds the $\dot{V}O_2$ kinetics during arm exercise above the heart level. *Med Sci Sports Exerc* 37: 613–619, 2005.
34. Krstrup P, Gonzalez-Alonso J, Quistorff B, Bangsbo J. Muscle heat production and anaerobic energy turnover during repeated intense dynamic exercise in humans. *J Physiol* 536: 947–956, 2001.
35. Krstrup P, Soderlund K, Mohr M, Bangsbo J. Slow-twitch fiber glycogen depletion elevates moderate-exercise fast-twitch fiber activity and O₂ uptake. *Med Sci Sports Exerc* 36: 973–982, 2004.
36. Krstrup P, Soderlund K, Mohr M, Bangsbo J. The slow component of oxygen uptake during intense, sub-maximal exercise in man is associated with additional fibre recruitment. *Pflügers Arch* 447: 855–866, 2004.
37. Lamarra N, Whipp BJ, Ward SA, Wasserman K. Effect of interbreath fluctuations on characterizing exercise gas exchange kinetics. *J Appl Physiol* 62: 2003–2012, 1987.
38. Leyk D, Essfeld D, Hoffmann U, Wunderlich HG, Baum K, Stegemann J. Postural effect on cardiac output, oxygen uptake and lactate during cycle exercise of varying intensity. *Eur J Appl Physiol* 68: 30–35, 1994.
39. MacDonald MJ, Shoemaker JK, Tschakovsky ME, Hughson RL. Alveolar oxygen uptake and femoral artery blood flow dynamics in upright and supine leg exercise in humans. *J Appl Physiol* 85: 1622–1628, 1998.
40. McDonough P, Behnke BJ, Padilla DJ, Musch TI, Poole DC. Control of microvascular oxygen pressures in rat muscles comprised of different fiber types. *J Physiol* 563: 903–913, 2005.
41. Moritani T, Sherman WM, Shibata M, Matsumoto T, Shinohara M. Oxygen availability and motor unit activity in humans. *Eur J Appl Physiol* 64: 552–556, 1992.
42. Moritani T, Takaishi T, Matsumoto T. Determination of maximal power output at neuromuscular fatigue threshold. *J Appl Physiol* 74: 1729–1734, 1993.
43. Poole DC, Barstow TJ, McDonough P, Jones AM. Control of oxygen uptake during exercise. *Med Sci Sports Exerc* 40: 462–474, 2008.
44. Poole DC, Ferreira LF, Behnke BJ, Barstow TJ, Jones AM. The final frontier: oxygen flux into muscle at exercise onset. *Exerc Sport Sci Rev* 35: 166–173, 2007.
45. Pringle JS, Doust JH, Carter H, Tolfrey K, Campbell IT, Sakkas GK, Jones AM. Oxygen uptake kinetics during moderate, heavy and severe intensity “submaximal” exercise in humans: the influence of muscle fibre type and capillarisation. *Eur J Appl Physiol* 89: 289–300, 2003.
46. Pringle JS, Doust JH, Carter H, Tolfrey K, Jones AM. Effect of pedal rate on primary and slow-component oxygen uptake responses during heavy-cycle exercise. *J Appl Physiol* 94: 1501–1507, 2003.
47. Sahlin K, Sørensen JB, Gladden LB, Rossiter HB, Pedersen PK. Prior heavy exercise eliminates $\dot{V}O_2$ slow component and reduces efficiency during submaximal exercise in humans. *J Physiol* 564: 765–773, 2005.
48. Saitoh T, Ferreira LF, Barstow TJ, Poole DC, Ooue A, Kondo N, Koga S. Effects of prior heavy exercise on heterogeneity of muscle deoxygenation kinetics during subsequent heavy exercise. *Am J Physiol Regul Integr Comp Physiol* 297: R615–R621, 2009.
49. Scheuermann BW, Hoelting BD, Noble ML, Barstow TJ. The slow component of O₂ uptake is not accompanied by changes in muscle EMG during repeated bouts of heavy exercise in humans. *J Physiol* 531: 245–256, 2001.
50. Seiyama A, Hazeki O, Tamura M. Noninvasive quantitative analysis of blood oxygenation in rat skeletal muscle. *J Biochem (Tokyo)* 103: 419–424, 1988.
51. Tordi N, Perrey S, Harvey A, Hughson RL. Oxygen uptake kinetics during two bouts of heavy cycling separated by fatiguing sprint exercise in humans. *J Appl Physiol* 94: 533–541, 2003.
52. Whipp BJ, Davis JA, Torres F, Wasserman K. A test to determine parameters of aerobic function during exercise. *J Appl Physiol* 50: 217–221, 1981.
53. Whipp BJ, Rossiter H. The kinetics of oxygen uptake: physiological inferences from the parameters. In: *Oxygen Uptake Kinetics in Sport, Exercise and Medicine*, edited by AM Jones and DC Poole. New York: Routledge, 2005, p. 62–94.
54. Whipp BJ, Ward SA, Lamarra N, Davis JA, Wasserman K. Parameters of ventilatory and gas exchange dynamics during exercise. *J Appl Physiol* 52: 1506–1513, 1982.
55. Wilkerson DP, Jones AM. Influence of initial metabolic rate on pulmonary O₂ uptake on-kinetics during severe intensity exercise. *Respir Physiol Neurobiol* 152: 204–219, 2006.
56. Wilkerson DP, Jones AM. Effects of baseline metabolic rate on pulmonary O₂ uptake on-kinetics during heavy-intensity exercise in humans. *Respir Physiol Neurobiol* 156: 203–211, 2007.
57. Wilkerson DP, Koppo K, Barstow TJ, Jones AM. Effect of prior multiple-sprint exercise on pulmonary O₂ uptake kinetics following the onset of perimaximal exercise. *J Appl Physiol* 97: 1227–1236, 2004.



Contents lists available at ScienceDirect

Respiratory Physiology & Neurobiology

journal homepage: www.elsevier.com/locate/resphysiol



Influence of extreme pedal rates on pulmonary O₂ uptake kinetics during transitions to high-intensity exercise from an elevated baseline

Fred J. DiMenna^a, Daryl P. Wilkerson^a, Mark Burnley^b, Stephen J. Bailey^a, Andrew M. Jones^{a,*}

^a School of Sport and Health Sciences, St. Luke's Campus, University of Exeter, Heavitree Road, Exeter, Devon EX1 2LU, UK

^b Department of Sport and Exercise Science, Aberystwyth University, Ceredigion SY23 3FD, UK

ARTICLE INFO

Article history:

Accepted 3 August 2009

Keywords:

\dot{V}_{O_2} Kinetics
Phase II time constant
 \dot{V}_{O_2} Slow component
Work-to-work exercise
Cadence

ABSTRACT

We used extreme pedal rates to investigate the influence of muscle fibre recruitment on pulmonary \dot{V}_{O_2} kinetics during unloaded-to-moderate-intensity (U→M), unloaded-to-high-intensity (U→H), and moderate-intensity to high-intensity (M→H) cycling transitions. Seven healthy men completed transitions to 60% of the difference between gas-exchange threshold and peak \dot{V}_{O_2} from both an unloaded and a moderate-intensity (95% GET) baseline at cadences of 35 and 115 rpm. Pulmonary gas exchange was measured breath-by-breath and iEMG of the *m. vastus lateralis* and *m. gluteus maximus* was measured during all tests. At 35 rpm, the phase II time constant (τ_p) values for U→M, U→H, and M→H were 26 ± 7 , 31 ± 7 and 36 ± 8 s with the value for M→H being longer than for U→M ($P < 0.05$). At 115 rpm, the τ_p values for U→M, U→H, and M→H were 29 ± 8 , 48 ± 16 and 53 ± 20 s with the value for U→M being shorter than for the other two conditions ($P < 0.05$). The \dot{V}_{O_2} slow component was similar at both cadences, but iEMG only increased beyond minute 2 during high-intensity cycling at 115 rpm. These results demonstrate that \dot{V}_{O_2} kinetics are influenced by an interaction of exercise intensity and pedal rate and are consistent with the notion that changes in muscle fibre recruitment are responsible for slower phase II \dot{V}_{O_2} kinetics during high-intensity and work-to-work exercise transitions.

© 2009 Elsevier B.V. All rights reserved.

1. Introduction

When muscular work is abruptly increased to an intensity that does not engender a sustained elevation in blood lactate concentration ([lactate], i.e. moderate-intensity exercise below the lactate threshold; LT), pulmonary oxygen uptake (\dot{V}_{O_2}) rises exponentially to achieve a new steady state after a short delay (Whipp and Mahler, 1980; Whipp et al., 1982). In healthy, young subjects, an 'unloaded'-to-moderate cycling transition is typically characterised by a \dot{V}_{O_2} time constant (τ ; time to achieve 63% of the response) of 20–35 s, which indicates that the response is functionally complete within 2–3 min. However, when a similar transition is made to a work rate above LT (i.e. heavy/severe exercise), this 'fundamental' response is accompanied by an additional component that elevates \dot{V}_{O_2} above the value predicted for the work rate (Whipp and Wasserman, 1972; Linnarsson, 1974; Barstow and Mole, 1991). The mechanistic basis of this ' \dot{V}_{O_2} slow component' is still debated (Borroni et al., 2009; Zoladz et al., 2008; see Poole and Jones, 2005 for review).

The phase II \dot{V}_{O_2} kinetics are known to be slower when both moderate and heavy/severe transitions are initiated from an elevated baseline work rate (i.e. during 'work-to-work' transitions

(Hughson and Morrissey, 1982, 1983; di Prampero et al., 1989; Brittain et al., 2001; MacPhee et al., 2005; Wilkerson and Jones, 2006, 2007; DiMenna et al., 2008). The original explanation for slower \dot{V}_{O_2} kinetics in these circumstances was that muscle O₂ delivery was limiting O₂ consumption (Hughson and Morrissey, 1982, 1983; Hughson, 2005). However, further investigation has shown that prior exercise that increases muscle O₂ availability does not reduce τ_p during subsequent work-to-work transitions spanning moderate-to-high intensities (DiMenna et al., 2008).

The lengthening of phase II \dot{V}_{O_2} kinetics during work-to-work transitions might be explained by differences in muscle fibre recruitment (Brittain et al., 2001; Wilkerson and Jones, 2006, 2007; DiMenna et al., 2008). Henneman's size principle indicates that fibres are recruited in a hierarchical manner depending primarily upon the intensity of the activity being undertaken (Henneman and Mendell, 1981). The smallest motoneurons that typically innervate fibres with the highest oxidative capacity are recruited first and would, therefore, be expected to contribute substantially in the moderate region where \dot{V}_{O_2} kinetics is most rapid (Brittain et al., 2001). Conversely, larger motor units that are positioned higher in the recruitment hierarchy comprise type II fibres which might be expected to exhibit slower \dot{V}_{O_2} kinetics (Crow and Kushmerick, 1982). This recruitment hierarchy is exemplified by the measured profile of muscle glycogen depletion, which indicates exclusive type I fibre involvement during

* Corresponding author. Tel.: +44 01392 262886; fax: +44 01392 264726.
E-mail address: a.m.jones@exeter.ac.uk (A.M. Jones).

moderate exercise compared with the activation of both principal fibre types during more intense efforts (Gollnick et al., 1974; Krstrup et al., 2004). On this basis, it is likely that higher order fibres would make a proportionately greater contribution to force production during transitions to high-intensity exercise initiated from a moderate-intensity baseline (Wilkerson and Jones, 2007; DiMenna et al., 2008). With the assumption that muscle fibres that are positioned higher in the recruitment hierarchy have an innately slower oxidative metabolic response (Crow and Kushmerick, 1982), it might be predicted that phase II \dot{V}_{O_2} kinetics would be relatively fast for low-intensity exercise, relatively slow during work-to-work transitions (such as in the transition from low-intensity to high-intensity exercise) and intermediate for high-intensity exercise, i.e. unloaded-to-moderate $\tau_p <$ unloaded-to-high-intensity $\tau_p <$ moderate-to-high-intensity τ_p .

In addition to work intensity, progression through the fibre recruitment hierarchy is influenced by muscle contraction frequency and it is generally accepted that the proportional contribution of higher order fibres is greater at higher compared to lower pedal rates (Sargeant, 1999; MacIntosh et al., 2000; Ferguson et al., 2001). Therefore, at the same relative exercise intensity, manipulation of pedal rate would be expected to alter the oxidative response heterogeneity by causing a shift toward a greater contribution of low-order fibres at extremely slow cadences and toward a greater contribution of high-order fibres at extremely rapid ones. The use of cadence extremes in conjunction with the work-to-work model could, therefore, provide further insight into the degree to which the altered \dot{V}_{O_2} kinetics during work-to-work high-intensity transitions are related to the metabolic properties of the recruited muscle fibres, as has been suggested by us and others (Brittain et al., 2001; Poole and Jones, 2005; Wilkerson and Jones, 2006, 2007; DiMenna et al., 2008).

On the basis of the expected motor unit recruitment profiles (see above), we tested the hypotheses that: (1) at 35 rpm, τ_p would be similar for U → M and U → H (i.e. unloaded-to-moderate-intensity $\tau_p =$ unloaded-to-high-intensity $\tau_p <$ moderate-to-high-intensity τ_p); and (2) at 115 rpm, τ_p would be similar for U → H and M → H (i.e. unloaded-to-moderate-intensity $\tau_p <$ unloaded-to-high-intensity $\tau_p =$ moderate-to-high-intensity τ_p). We used EMG to assess the degree to which motor unit activation was altered at extreme pedal rates.

2. Methods

2.1. Subjects

Seven male subjects (mean \pm SD age 31 ± 8 years, stature 1.79 ± 0.02 m, mass 81.5 ± 7.5 kg) volunteered and gave written informed consent to participate in this study, which had been approved by the local Research Ethics Committee. The subjects were all recreationally active and were familiar with the exercise mode and experimental procedures used in the present study. On test days, subjects were instructed to report to the laboratory in a rested state, having completed no strenuous exercise within the previous 24 h, and having abstained from food, alcohol and caffeine for the preceding 3 h.

2.2. Experimental overview

In the present study, we combined previously published data for high-intensity transitions (U → H) at extreme pedal rates (see DiMenna et al., 2009; conditions '35 Unprimed' and '115 Unprimed') with additional data characterizing similar transitions completed in two steps (U → M, unloaded-to-moderate-intensity exercise; and M → H, moderate-to-high-intensity exercise) to

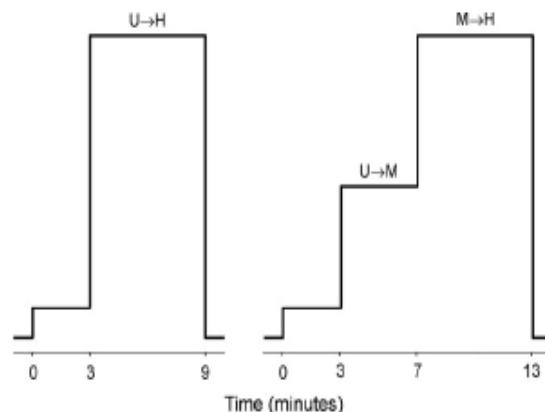

Fig. 1. Schematic illustration of the two experimental protocols. The protocol depicted on the left involved an abrupt transition from unloaded cycling to a high-intensity work rate that was completed in one full step (U → H). The protocol depicted on the right involved the same transition divided into two separate steps (i.e. lower step, U → M; upper step, M → H). U → H was performed four times at each pedal rate; U → M/M → H was performed three times at each pedal rate.

examine the effect of pedal rate on \dot{V}_{O_2} kinetics during work-to-work transitions.

All testing was completed in an air-conditioned laboratory at a temperature of 20–22 °C. The subjects visited the laboratory on 16 occasions over a 6-week period to perform exercise tests on an electronically braked cycle ergometer (Lode Excalibur Sport, Groningen, the Netherlands). This device allows for the maintenance of a prescribed constant power output across a wide range of pedal cadences by instantaneously adjusting flywheel resistance via electrical braking.

Testing was conducted at the same time of day (± 2 h) for each subject. On each of the first two visits, the subjects completed a ramp incremental exercise test for determination of cadence-specific peak \dot{V}_{O_2} ($\dot{V}_{O_{2peak}}$) and gas-exchange threshold (GET). One test was performed at a pedal rate of 35 rpm, the other at a pedal rate of 115 rpm, and test order was alternated among subjects. On each of the 14 subsequent visits, subjects completed a bout of high-intensity exercise (at a work rate calculated to require 60% of the difference between the GET and $\dot{V}_{O_{2peak}}$, i.e., 60% " Δ ") initiated from either 'unloaded' (20 W) cycling or moderate (95% GET) cycling (work-to-work transition). Four repetitions of the full transition (from an unloaded baseline) and three repetitions of the work-to-work transition were performed at both 35 and 115 rpm. Each laboratory visit was separated by at least 48 h. The two protocols are depicted in Fig. 1.

2.3. Experimental procedures

The ramp incremental exercise tests consisted of 3 min of pedaling at 0 W, followed by a continuous ramped increase in work rate of 30 W/min until the subject was unable to continue. The subjects were asked to maintain the prescribed cadence and instruction was given if/when they deviated by more than ± 5 rpm. Saddle and handlebar heights were recorded and the same settings were reproduced on subsequent tests. The $\dot{V}_{O_{2peak}}$ was defined as the highest 30 s mean value recorded before the subject's volitional termination of the test. The GET was determined from a cluster of measures including: (1) the first disproportionate increase in carbon dioxide output (\dot{V}_{CO_2}) from visual inspection of individual plots of \dot{V}_{CO_2} vs. \dot{V}_{O_2} ; (2) an increase in \dot{V}_E/\dot{V}_{O_2} (\dot{V}_E , expiratory ventilation) with no increase in \dot{V}_E/\dot{V}_{CO_2} ; (3) an increase in end-tidal O₂ tension with no fall in end-tidal CO₂ tension. When there was lack of agreement between these measures, the more conservative estimate was

accepted to give greater confidence that exercise designed to be of moderate intensity was indeed performed below the GET. The work rates that would require 95% of the cadence-specific GET and 60% of the difference (Δ) between the cadence-specific GET and $\dot{V}_{O_2 \text{ peak}}$ were estimated for each cadence, with account taken of the mean response time of the \dot{V}_{O_2} response to ramp exercise (assumed to approximate two-thirds of the ramp rate, i.e. 20 W) (Whipp et al., 1981). These work rates were applied during the subsequent step tests.

The subjects returned to the laboratory on 14 occasions to perform one of the following protocols: (1) 3 min of 'unloaded' cycling at 20 W and 6 min of high-intensity cycling; (2) 3 min of 'unloaded' cycling at 20 W, 4 min of moderate-intensity cycling and 6 min of high-intensity cycling. The first protocol provided data for transitions from unloaded pedalling to high-intensity exercise (i.e. U \rightarrow H₃₅ and U \rightarrow H₁₁₅ for trials performed at 35 and 115 rpm, respectively). The second protocol provided data for both moderate (i.e. U \rightarrow M₃₅ and U \rightarrow M₁₁₅ for trials performed at 35 and 115 rpm, respectively) and work-to-work (i.e. M \rightarrow H₃₅ and M \rightarrow H₁₁₅ for trials performed at 35 and 115 rpm, respectively) transitions. The \dot{V}_{O_2} responses from like-transitions (four per cadence for the first protocol, three per cadence for the second) were averaged prior to any analysis being performed in order to enhance the signal-to-noise ratio and improve confidence in the parameters derived from the model fits (Lamarra et al., 1987; Whipp and Rossiter, 2005).

During all tests, pulmonary gas exchange and ventilation were measured continuously using a portable metabolic cart (MetaMax 3B, Cortex Biophysik, Leipzig, Germany). A DVT turbine digital transducer measured inspired and expired airflow while an electro-chemical cell O₂ analyzer and ND infrared CO₂ analyzer simultaneously measured expired gases. Subjects wore a nose clip and breathed through a low-dead-space, low-resistance mouthpiece that was securely attached to the volume transducer. The inspired and expired gas volume and gas concentration signals were continuously sampled via a capillary line connected to the mouthpiece. The gas analyzers were calibrated before each test with gases of known concentration and the turbine volume transducer was calibrated using a 3-l syringe (Hans Rudolph, Kansas City, MO). Pulmonary gas exchange and ventilation were calculated and displayed breath-by-breath. Heart rate (HR) was calculated over the duration of each breath during all tests using short-range radiotelemetry (Polar S610, Polar Electro Oy, Kempele, Finland). During one of the trials under each condition, a blood sample from a fingertip was collected into a capillary tube over the 20 s preceding the step transitions in work rate and within the last 20 s of exercise and subsequently analyzed to determine blood [lactate] (YSI 1500, Yellow Springs Instruments, Yellow Springs, OH, United States). Blood lactate accumulation (Δ blood [lactate]) was calculated as the difference between blood [lactate] at end exercise and blood [lactate] at baseline.

Neuromuscular activity of the *m. vastus lateralis* and *m. gluteus maximus* muscles of the left leg was measured using bipolar surface electromyography. The leg was initially shaved and cleaned with alcohol around the belly of the two muscles and graphite snap electrodes (Unilect 40713, Unomedical, Stonehouse, Great Britain) were adhered to the prepared areas in a bipolar arrangement (interelectrode distance 40 mm). Ground electrodes were positioned according to the recommendations provided in the EMG software (Mega Electronics Ltd., Finland). To secure electrodes and wires in place and to minimize movement during cycling, elastic bandages were wrapped around the subject's leg. Pen marks were made around the electrodes to enable reproduction of the placement in subsequent tests. The EMG signal was recorded using a ME3000PB Muscle Tester (Mega Electronics Ltd., Finland).

EMG measurements at a sampling frequency of 1000 Hz were recorded throughout all exercise tests. The bipolar signal was amplified (amplifier input impedance > 1 M Ω) and data were collected online in raw form and stored on a personal computer using MegaWin software (Mega Electronics Ltd., Finland). The raw EMG data was subsequently exported as an ASCII file and digitally filtered using Labview 8.2 (National Instruments Corporation Ltd., Newbury, England). Initially, the signals were filtered with a 20 Hz high-pass second-order Butterworth filter to remove contamination from movement artefacts. The signal was then rectified and low-pass filtered at a frequency of 50 Hz to produce a linear envelope. The average iEMG for both muscles were calculated for 15 s intervals throughout exercise with these values normalised to the average measured during 15–180 s of unloaded cycling prior to the initial transition. Therefore, all iEMG data are presented as a percentage of the initial unloaded cycling phase. Data from repeat trials were averaged for each muscle and individual-muscle values were summed to provide an estimate of total muscle activity during exercise. To determine the delayed-onset change in iEMG, the summed average at minute 2 (105–120 s) was compared with the summed average at the end of exercise (225–240 s for the moderate-intensity bouts, 345–360 s for the high-intensity bouts).

2.4. Data analysis procedures

The breath-by-breath \dot{V}_{O_2} data from each test were initially examined to exclude errant breaths caused by coughing, swallowing, sighing, etc., and those values lying more than four standard deviations from the local mean were removed. The breath-by-breath data were subsequently linearly interpolated to provide second-by-second values and, for each individual, identical repetitions were time-aligned to the start of exercise and ensemble-averaged. The first 20 s of data after the onset of exercise (i.e., the phase I response) were deleted (Whipp and Rossiter, 2005) and a nonlinear least-square algorithm was used to fit the data, as described in the following biexponential equation:

$$\dot{V}_{O_2}(t) = \dot{V}_{O_2 \text{ baseline}} + A_p(1 - e^{-(t-TD_p)/\tau_p}) + A_s(1 - e^{-(t-TD_s)/\tau_s})$$

where $\dot{V}_{O_2}(t)$ represents the absolute \dot{V}_{O_2} at a given time t ; $\dot{V}_{O_2 \text{ baseline}}$ represents the mean \dot{V}_{O_2} in the baseline period; A_p , TD_p , and τ_p represent the amplitude, time delay, and time constant, respectively, describing the phase II increase in \dot{V}_{O_2} above baseline; and A_s , TD_s , and τ_s represent the amplitude of, time delay before the onset of, and time constant describing the development of, the \dot{V}_{O_2} slow component, respectively. For moderate-intensity exercise transitions, the second term invariably dropped out. An iterative process was used to minimise the sum of the squared errors between the fitted function and the observed values. $\dot{V}_{O_2 \text{ baseline}}$ was defined as the mean \dot{V}_{O_2} measured over the final 90 s of baseline pedaling. The end-exercise \dot{V}_{O_2} was defined as the mean \dot{V}_{O_2} measured over the final 30 s of exercise. Because the asymptotic value (A_s) of the exponential term describing the \dot{V}_{O_2} slow component may represent a higher value than is actually reached at the end of the exercise, the actual amplitude of the \dot{V}_{O_2} slow component at the end of exercise was defined as A_s' . The amplitude of the slow component was also described relative to the entire \dot{V}_{O_2} response. In addition, the functional 'gain' (G) of the fundamental \dot{V}_{O_2} response was computed by dividing A_p by the Δ work rate. The functional gain of the entire response (i.e., end-exercise 'gain') was calculated in a similar manner.

2.5. Statistics

The parameters derived from the modelling of the \dot{V}_{O_2} data were analyzed using one-way repeated measures analysis of variance

Table 1
O₂ uptake kinetics and blood [lactate] during U → M₃₅, U → H₃₅ and M → H₃₅.

	U → M ₃₅	U → H ₃₅	M → H ₃₅
Baseline \dot{V}_{O_2} (Lmin ⁻¹)	0.62 ± 0.03	0.63 ± 0.05	1.28 ± 0.21 [†]
Phase II τ (s)	26 ± 7	31 ± 7	36 ± 8 [†]
Phase II time delay (s)	10 ± 3	13 ± 3 [*]	9 ± 5
Fundamental phase amplitude (Lmin ⁻¹)	0.66 ± 0.21	2.03 ± 0.17 [†]	1.40 ± 0.19 [†]
Fundamental phase gain (mLmin ⁻¹ W ⁻¹)	9.9 ± 0.5	10.6 ± 0.5 [*]	11.3 ± 0.4 [†]
\dot{V}_{O_2} slow component time delay (s)	-	139 ± 48	149 ± 40
\dot{V}_{O_2} slow component amplitude (Lmin ⁻¹)	-	0.27 ± 0.10	0.30 ± 0.13
\dot{V}_{O_2} slow component relative amplitude (%)	-	12 ± 5	14 ± 7
End-exercise \dot{V}_{O_2} (Lmin ⁻¹)	1.29 ± 0.20	2.92 ± 0.12 [†]	2.91 ± 0.12 [†]
End-exercise \dot{V}_{O_2} (% peak)	39 ± 6	88 ± 5 [*]	88 ± 5 [*]
End-exercise gain (mLmin ⁻¹ W ⁻¹)	9.9 ± 0.5	12.0 ± 0.4 [*]	13.1 ± 1.0 [†]
Baseline blood [lactate] (mM)	0.6 ± 0.2	0.7 ± 0.3	0.8 ± 0.2
End-exercise blood [lactate] (mM)	0.8 ± 0.2	3.4 ± 0.9 [*]	3.2 ± 0.8 [*]

Values are means ± SD. U → M₃₅ - unloaded-to-moderate-intensity exercise at 35 rpm; U → H₃₅ - unloaded-to-high-intensity exercise at 35 rpm; M → H₃₅ - moderate-to-high-intensity exercise at 35 rpm.

^{*} Significantly different from U → M₃₅ condition ($P < 0.05$).

[†] Significantly different from U → H₃₅ condition ($P < 0.05$).

with Fisher's least significant difference tests, as appropriate, to identify the location of statistically significant differences between the three conditions for each pedal rate. Paired *t*-tests were used to compare: (1) \dot{V}_{O_2} kinetics within conditions across cadence; (2) \dot{V}_{O_2} slow component amplitude across conditions within cadence; (3) the average iEMG at minute 2 with the average iEMG at end exercise for each condition within cadence. Results are reported as mean ± SD.

3. Results

The peak work rate attained on the incremental test at 35 rpm was 311 ± 17 W, the GET work rate was 91 ± 20 W and the corresponding work rates for moderate- and high-intensity exercise were 86 ± 19 and 211 ± 9 W, respectively. The peak work rate attained on the incremental test at 115 rpm was 318 ± 36 W, the GET work rate was 66 ± 9 W and the corresponding work rates for moderate- and high-intensity exercise were 62 ± 8 and 205 ± 26 W, respectively.

3.1. \dot{V}_{O_2} Kinetics for U → M, U → H and M → H at 35 rpm

The \dot{V}_{O_2} response parameters for U → M₃₅, U → H₃₅ and M → H₃₅ are reported in Table 1. As per the experimental design, the baseline \dot{V}_{O_2} was significantly higher for M → H₃₅ compared with both U → M₃₅ and U → H₃₅. The phase II τ became progressively longer for the U → M₃₅, U → H₃₅ and M → H₃₅ conditions (U → M₃₅, 26 ± 7 s; U → H₃₅, 31 ± 7 s; M → H₃₅, 36 ± 8 s; see Table 1 for statistical comparison and Fig. 2, top panel). A_p was least for U → M₃₅, greatest for U → H₃₅ and intermediate for M → H₃₅, with all conditions different from each other; however, the gain during both the fundamental phase (G_p) and entire bout was least for U → M₃₅, greatest for M → H₃₅ and intermediate for U → H₃₅, with all conditions different from each other. The slow component amplitude and time delay were not significantly different for the high-intensity conditions.

3.2. \dot{V}_{O_2} Kinetics for U → M, U → H and M → H at 115 rpm

The \dot{V}_{O_2} response parameters for U → M₁₁₅, U → H₁₁₅ and M → H₁₁₅ are reported in Table 2. As per the experimental design, the baseline \dot{V}_{O_2} was significantly higher for M → H₁₁₅ compared with both U → M₁₁₅ and U → H₁₁₅. The phase II τ was shorter for the U → M₁₁₅ compared to the U → H₁₁₅ and M → H₁₁₅ conditions (U → M₁₁₅, 29 ± 8 s; U → H₁₁₅, 48 ± 16 s; M → H₁₁₅, 53 ± 20 s; see

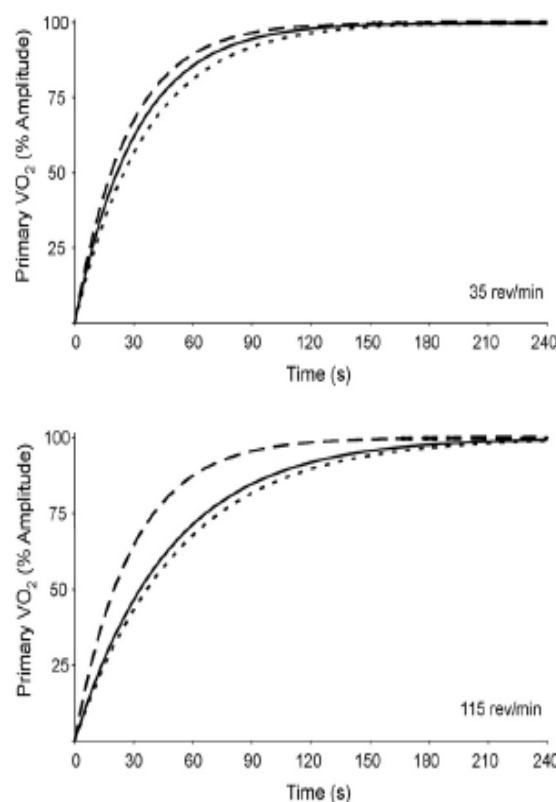

Fig. 2. Group mean primary \dot{V}_{O_2} response following the onset of exercise at each pedal rate (top panel, 35 rpm; bottom panel, 115 rpm), where \dot{V}_{O_2} is expressed relative to the amplitude of the primary response. The long-dashed line represents the U → M (unloaded-to-moderate-intensity) transition; the short-dashed line represents the M → H (moderate- to high-intensity; i.e. work-to-work) transition; and the solid line represents the U → H (unloaded-to-high-intensity) transition.

Table 2 for statistical comparison and Fig. 2, bottom panel). A_p was least for U → M₁₁₅, greatest for U → H₁₁₅ and intermediate for M → H₁₁₅, with all conditions different from each other. The G_p was not significantly different for the three conditions; however, end-exercise G was significantly lower for U → M₁₁₅ compared to both U → H₁₁₅ and M → H₁₁₅. The slow component amplitude and time delay were not significantly different among the high-intensity conditions.

Table 2
O₂ uptake kinetics and blood [lactate] during U → M₁₁₅, U → H₁₁₅ and M → H₁₁₅.

	U → M ₁₁₅	U → H ₁₁₅	M → H ₁₁₅
Baseline \dot{V}_{O_2} (Lmin ⁻¹)	1.49 ± 0.12	1.55 ± 0.22	1.81 ± 0.19 ^{*,†}
Phase II τ (s)	29 ± 8	48 ± 16 [*]	53 ± 20 [*]
Phase II time delay (s)	15 ± 8	8 ± 3	7 ± 9
Fundamental phase amplitude (Lmin ⁻¹)	0.30 ± 0.07	1.44 ± 0.21 [†]	1.21 ± 0.24 ^{*,†}
Fundamental phase gain (mLmin ⁻¹ W ⁻¹)	7.2 ± 2.1	7.8 ± 0.7	8.5 ± 1.5
\dot{V}_{O_2} slow component time delay (s)	-	146 ± 27	150 ± 37
\dot{V}_{O_2} slow component amplitude (Lmin ⁻¹)	-	0.30 ± 0.13	0.19 ± 0.09
\dot{V}_{O_2} slow component relative amplitude (%)	-	17 ± 7	14 ± 7
End-exercise \dot{V}_{O_2} (Lmin ⁻¹)	1.77 ± 0.14	3.27 ± 0.31 [†]	3.20 ± 0.26 [*]
End-exercise \dot{V}_{O_2} (% peak)	49 ± 6	91 ± 7 [*]	89 ± 6 [*]
End-exercise gain (mLmin ⁻¹ W ⁻¹)	7.2 ± 2.1	9.3 ± 0.8 [*]	9.8 ± 1.0 [*]
Baseline blood [lactate] (mM)	0.8 ± 0.3	0.8 ± 0.3	1.0 ± 0.2
End-exercise blood [lactate] (mM)	1.0 ± 0.2	5.2 ± 1.0 [*]	4.9 ± 0.6 [*]

Values are means ± SD. U → M₁₁₅ - unloaded-to-moderate-intensity exercise at 115 rpm; U → H₁₁₅ - unloaded-to-high-intensity exercise at 115 rpm; M → H₁₁₅ - moderate-to-high-intensity exercise at 115 rpm.

* Significantly different from U → M₁₁₅ condition ($P < 0.05$).

† Significantly different from U → H₁₁₅ condition ($P < 0.05$).

3.3. iEMG responses

Fig. 3 illustrates the summed mean iEMG response throughout U → M and U → H at each pedal rate for a representative subject.

The summed mean iEMG at the end of exercise was significantly greater than the summed mean iEMG at minute 2 for both high-intensity cycling bouts at 115 rpm (U → H₁₁₅, 509 ± 206% at minute 6 vs. 469 ± 190% at minute 2; M → H₁₁₅, 424 ± 114% at minute

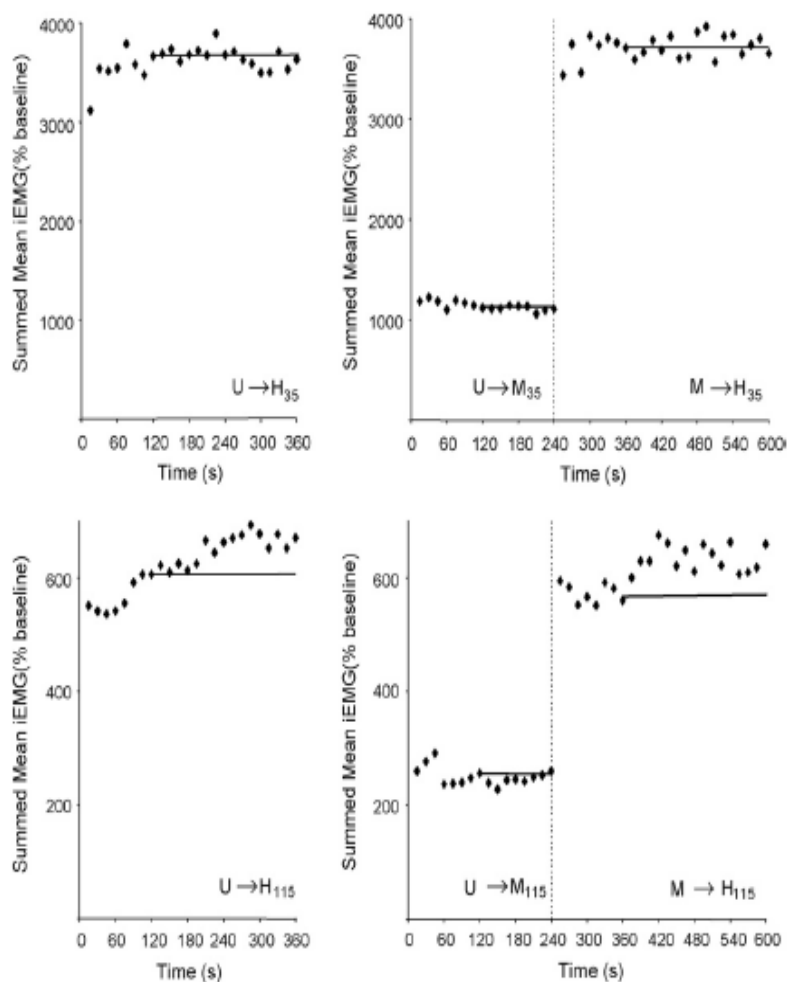

Fig. 3. Summed mean iEMG response throughout U → H (left) and U → M/M → H (right) at 35 rpm (top) and 115 rpm (bottom) for a representative subject. Vertical dashed line in right graphs indicates the abrupt transition from U → M to M → H. Horizontal lines are aligned with the summed mean 2-min values. Notice how iEMG remains relatively constant from minute 2 during U → M at both cadences and during U → H₃₅ and M → H₃₅. However, during U → H₁₁₅ and M → H₁₁₅, iEMG increases so that the average at minute 6 is greater than the average at minute 2. Note: Scaling difference between top- and bottom-panel y-axis is a function of the very different iEMG activity required to maintain baseline pedalling at the disparate pedal rates.

6 vs. $383 \pm 122\%$ at minute 2; $P < 0.05$ and $P < 0.01$, respectively). However, for moderate-intensity cycling at both cadences and high-intensity cycling at 35 rpm, summed mean iEMG was not significantly different at the end of exercise compared with minute 2 ($P > 0.05$ in all cases).

4. Discussion

The principal finding of this investigation was that manipulation of the pedal rate (and, presumably, the contribution of different muscle fibre pools to force production) altered the expected relationship between the τ_p values for moderate-intensity exercise, high-intensity exercise, and moderate-to-high-intensity exercise. Specifically, at 35 rpm, τ_p was not different between U → M and U → H, but was significantly greater for M → H, whereas at 115 rpm, τ_p was smallest at U → M and significantly greater at both U → H and M → H. These data, therefore, indicate that work intensity and pedal rate interact to influence the kinetics of \dot{V}_{O_2} in the transition from one metabolic rate to another.

It has been suggested that manipulation of pedal rate during cycle exercise provides a useful way to investigate the influence of muscle fibre type and motor unit recruitment on \dot{V}_{O_2} kinetics (Barstow et al., 1996; Jones et al., 2005). The relative contribution to force production of higher order (type II) fibres is believed to be greater at high contraction rates (Sargeant, 1999; MacIntosh et al., 2000) and there is evidence to suggest that these fibres have slower O₂ uptake kinetics in both small mammals and exercising humans (Crow and Kushmerick, 1982; Pringle et al., 2003a). Consequently, the markedly slower \dot{V}_{O_2} response (i.e. lengthened τ_p and/or increased amplitude of the \dot{V}_{O_2} slow component) that has been reported for high-intensity cycling at high cadences has been interpreted to represent an 'unveiling' of the response characteristics of this fibre group (Pringle et al., 2003b; Migita and Hirakoba, 2006; DiMenna et al., 2009). Pedal-rate extremes can, therefore, be useful in identifying the extent to which interventions known to influence \dot{V}_{O_2} kinetics do so through their influence on specific segments of the fibre pool (DiMenna et al., 2009).

It has been shown that phase II \dot{V}_{O_2} kinetics measured across the transition from moderate-intensity to high-intensity exercise is markedly slower compared with transitions made from unloaded cycling to the same high-intensity work rate (Wilkerson and Jones, 2006, 2007; DiMenna et al., 2008). Henneman's size principle indicates that motor units are recruited sequentially from smallest (slow-twitch oxidative; type I) to largest (fast-twitch glycolytic; type II x) depending primarily on the intensity of the contractions being performed (Henneman and Mendell, 1981). Therefore, a possible explanation for slower phase II \dot{V}_{O_2} kinetics during work-to-work transitions is that the initiation of high-intensity exercise from a moderate-intensity baseline mandates the recruitment of a pool of high-order fibres with metabolic properties that are more homogeneous (relative to that which would exist during transitions from unloaded cycling to high-intensity exercise). A lengthened τ_p for transitions from unloaded-to-high-intensity cycling compared to transitions from unloaded-to-moderate-intensity cycling would also be expected because fibres spanning a greater range of oxidative response heterogeneity would be involved in the former.

Consistent with our hypotheses, we observed that at 35 rpm, τ_p was similar for U → M and U → H whereas, at 115 rpm, τ_p was similar for U → H and M → H. We attribute these effects to a pedal rate (and fibre recruitment) skewing of the \dot{V}_{O_2} response such that the U → H transition more closely reflected the response characteristics of low-order fibres at 35 rpm and of high-order fibres at 115 rpm. However, a surprising finding was that the 35 rev/min, the U → H transition τ_p was also similar to the M → H transition τ_p ; therefore, the lengthening of τ_p during work-to-work transitions

that has been documented at mid-range pedal rates (Wilkerson and Jones, 2007) was absent at both pedal-rate extremes. A possible explanation for this unexpected finding at 35 rpm is that despite the slow cadence that was maintained (and associated skewing toward low-order fibre involvement), the intensity of the bout mandated sufficient drive through the recruitment hierarchy that the proportional contribution of high-order fibres was still appreciable during the transition to high-intensity exercise from a baseline of unloaded cycling. However, it is important to note that the group mean τ_p values characterising the three transitions spanned a far narrower range at 35 rpm (from 26 to 36 s) compared to 115 rpm (from 29 to 53 s), which is consistent with the involvement of a more homogenous pool of fibres residing lower in the recruitment hierarchy at the slower pedal rate. Moreover, in addition to the significantly longer τ_p for U → H transitions at 115 compared to 35 rpm that we have reported previously (DiMenna et al., 2009), we found that τ_p at 115 rpm was also significantly longer than at 35 rpm for the M → H, but not for the U → M transition (see Fig. 4). This is consistent with greater expression of the oxidative response characteristics of high-order fibres during extremely rapid cycling only under circumstances where the work rate is sufficiently high to mandate a substantial drive for fibre recruitment.

It is possible that heterogeneity of the metabolic characteristics of muscle fibres recruited during transitions from unloaded-to-high-intensity exercise might be responsible for at least part of the \dot{V}_{O_2} slow component that is observed during high-intensity exercise (Jones et al., 2005). For example, if a transition to high-intensity exercise from an unloaded baseline required the initial recruitment of fibres with an extremely wide range of τ_p values, the profiles of the slowest responders might project past the asymptote of the phase II exponential (as established by conventional curve-fitting procedures), thereby creating a 'separate' response phase that appears to be of delayed onset (Barstow and Mole, 1991; Paterson and Whipp, 1991; Wilkerson and Jones, 2007). Reducing this heterogeneity by initiating high-intensity exercise from a moderate-intensity exercise baseline could allow this slow component to be 'reclassified' into a more homogenous and, therefore, slower phase II response. The reported reduction in slow component amplitude (Wilkerson and Jones, 2007; DiMenna et al., 2008)

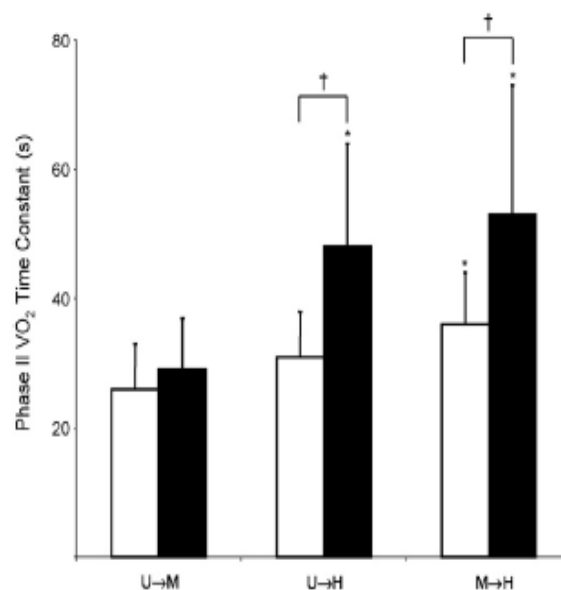

Fig. 4. Group mean phase II \dot{V}_{O_2} τ for U → M, U → H and M → H at each pedal rate (open bars, 35 rpm; closed bars, 115 rpm). *Significant difference within pedal rate compared with U → M ($P < 0.05$); †Significant difference between pedal rates for that condition ($P < 0.05$).

and increased phase II G (gain; increase in \dot{V}_{O_2} per work-rate increment; Wilkerson and Jones, 2007) for work-to-work compared to high-intensity transitions from an unloaded baseline is consistent with this suggestion. In contrast to these previous reports at mid-range pedal rates, we found no difference in the amplitude of the \dot{V}_{O_2} slow component between U → H or M → H at either 35 or 115 rpm. These findings are also consistent with the suggestion that the employment of extreme pedal rates skewed fibre recruitment (and the corresponding primary \dot{V}_{O_2} response) in opposite directions.

Despite the fact that high-intensity exercise was performed at the same relative intensity (60% cadence-specific Δ) at 35 and 115 rpm, the iEMG at minute 6 was significantly greater than the iEMG at minute 2 for the U → H and M → H transitions at 115 rpm, but not at 35 rpm. A possible explanation is that greater involvement of fatigue-sensitive high-order fibres from the onset of exercise at 115 rpm mandated delayed-onset activation changes (e.g., a further drive through the recruitment hierarchy to previously inactive very-high-order fibres and/or increased rate coding in the fibres that were already involved) to maintain power output, resulting in a \dot{V}_{O_2} slow component. Conversely, at 35 rpm, greater involvement of fatigue-resistant low-order fibres at a contraction frequency closer to their optimal velocity of shortening (He et al., 2000) might have allowed high-intensity exercise to proceed with minimal delayed-onset changes in fibre activation. However, a \dot{V}_{O_2} slow component might still be present at 35 rpm because the projected response profiles of the slowest responding high-order fibres recruited at exercise onset would 'create' what appeared to be a delayed-onset phase. Regardless of the mechanism, however, these findings contribute to resolution of the debate concerning the role of delayed-onset fibre activation in the establishment of a \dot{V}_{O_2} slow component during high-intensity constant-work-rate exercise (Borroni et al., 2009; Zoladz et al., 2008). With the assumption that fibre activation can be inferred from EMG measurements (cf. Jones et al., 2005), our results indicate that a slow component of similar magnitude can be present both with and without delayed-onset changes in fibre activation.

5. Summary

We have shown marked differences in \dot{V}_{O_2} kinetics for U → M, U → H and M → H cycling transitions performed at extreme pedal rates. Specifically, the previously reported relationship at mid-range pedal rates (i.e. U → M τ_p < U → H τ_p < M → H τ_p) was altered at extreme pedal rates; at 35 rpm, the τ_p values for U → M, U → H, and M → H were 26 ± 7, 31 ± 7 and 36 ± 8 s with the value for M → H being longer than U → M; at 115 rpm, the τ_p values for U → M, U → H, and M → H were 29 ± 8, 48 ± 16 and 53 ± 20 s with the value for U → M being shorter than for the other two conditions. These data indicate that differences in pedal rate skewed the muscle fibre contribution to force production during U → H transitions toward characteristic lower order responses at 35 rpm and toward higher order responses at 115 rpm. We have also demonstrated that a \dot{V}_{O_2} slow component of similar magnitude can be present at the same relative exercise intensity both with and without temporal changes in iEMG that are consistent with delayed-onset fibre activation. These results indicate that the \dot{V}_{O_2} response following a step transition to a higher work rate is influenced both by the exercise intensity (pre- and post-transition) and the muscle contraction frequency.

References

Barstow, T.J., Mole, P., 1991. Linear and nonlinear characteristics of oxygen uptake kinetics during heavy exercise. *J. Appl. Physiol.* 71, 2099–2106.

- Barstow, T.J., Jones, A.M., Nguyen, H., Casaburi, R., 1996. Influence of muscle fibre type and pedal frequency on oxygen uptake kinetics of heavy exercise. *J. Appl. Physiol.* 81, 1642–1650.
- Borroni, F., Malatesta, D., Candau, R., 2009. Is progressive recruitment of fibres required for the development of the slow component of \dot{V}_{O_2} kinetics? *J. Appl. Physiol.* 106, 746.
- Brittain, C.J., Rossiter, H.B., Kowalchuk, J.M., Whipp, B.J., 2001. Effect of prior metabolic rate on the kinetics of oxygen uptake during moderate-intensity exercise. *Eur. J. Appl. Physiol.* 86, 125–134.
- Crow, M.T., Kushmerick, M.J., 1982. Chemical energetics of slow- and fast-twitch muscles of the mouse. *J. Gen. Physiol.* 79, 147–166.
- DiMenna, F.J., Wilkerson, D.P., Burnley, M., Jones, A.M., 2008. Influence of priming exercise on pulmonary O₂ uptake kinetics during transitions to high-intensity exercise from an elevated baseline. *J. Appl. Physiol.* 105, 538–546.
- DiMenna, F.J., Wilkerson, D.P., Burnley, M., Bailey, S.J., Jones, A.M., 2009. Influence of priming exercise on pulmonary O₂ uptake kinetics during transitions to high-intensity exercise at extreme pedal rates. *J. Appl. Physiol.* 106, 432–442.
- di Prampero, P.E., Mahler, P.B., Giezendanner, D., Cerretelli, P., 1989. Effects of priming exercise on \dot{V}_{O_2} kinetics and O₂ deficit at the onset of stepping and cycling. *J. Appl. Physiol.* 66, 2023–2031.
- Ferguson, R.A., Ball, D., Krustup, P., Aagaard, P., Kjær, M., Sargeant, A.J., Hellsten, Y., Bangsbo, J., 2001. Muscle oxygen uptake and energy turnover during dynamic exercise at different contraction frequencies in humans. *J. Physiol.* 536, 261–271.
- Gollnick, P.D., Pehl, K., Saltin, B., 1974. Selective glycogen depletion pattern in human muscle fibres after exercise of varying intensity and varying pedalling rates. *J. Physiol.* 241, 45–57.
- He, Z.H., Bottinelli, R., Pellegrino, M.A., Ferenczi, M.A., Reggiani, C., 2000. ATP consumption and efficiency of human single muscle fibres with different myosin isoform composition. *Biophys. J.* 79, 945–961.
- Henneman, E., Mendell, L.M., 1981. Functional organisation of motoneuron pool and its inputs. In: Brooks, V.B. (Ed.), *Handbook of Physiology I*, vol. II, part I. American Physiological Society, Bethesda, pp. 423–507.
- Hughson, R.L., Morrissey, M., 1982. Delayed kinetics of respiratory gas exchange in the transition from prior exercise. *J. Appl. Physiol.* 52, 921–929.
- Hughson, R.L., Morrissey, M., 1983. Delayed kinetics of \dot{V}_{O_2} in the transition from prior exercise. Evidence for O₂ transport limitation of \dot{V}_{O_2} kinetics: a review. *Int. J. Sports Med.* 4, 31–39.
- Hughson, R.L., 2005. Regulation of \dot{V}_{O_2} on-kinetics by O₂ delivery. In: Jones, A.M., Poole, D.C. (Eds.), *Oxygen Uptake Kinetics in Sport, Exercise and Medicine*. Routledge, London and New York, pp. 185–211.
- Jones, A.M., Pringle, J.S.M., Carter, H., 2005. Influence of muscle fibre type and motor unit recruitment on \dot{V}_{O_2} kinetics. In: Jones, A.M., Poole, D.C. (Eds.), *Oxygen Uptake Kinetics in Sport, Exercise and Medicine*. Routledge, London and New York, pp. 261–293.
- Krustup, P., Söderlund, K., Mohr, M., Bangsbo, J., 2004. The slow component of oxygen uptake during intense, sub-maximal exercise in man is associated with additional fibre recruitment. *Pflügers Arch.* 447, 855–866.
- Lamarra, N., Whipp, B.J., Ward, S.A., Wasserman, K., 1987. Effect of interbreath fluctuations on characterizing exercise gas exchange kinetics. *J. Appl. Physiol.* 62, 2003–2012.
- Linnarsson, D., 1974. Dynamics of pulmonary gas exchange and heart rate changes at start and end of exercise. *Acta Physiol. Scand.* 415, 1–68.
- MacIntosh, B.R., Neptune, R.R., Horton, J.F., 2000. Cadence, power, and muscle activation in cycle ergometry. *Med. Sci. Sports Exerc.* 32, 1281–1287.
- MacPhee, S.L., Shoemaker, J.K., Paterson, D.H., Kowalchuk, J.M., 2005. Kinetics of O₂ uptake, leg blood flow and muscle deoxygenation are slowed in the upper compared to lower regions of the moderate-intensity exercise domain. *J. Appl. Physiol.* 99, 1822–1834.
- Migita, T., Hirakoba, K., 2006. Effects of different pedal rates on oxygen uptake slow component during constant-load cycling exercise. *J. Sports Med. Phys. Fitness* 46, 189–196.
- Paterson, D.H., Whipp, B.J., 1991. Asymmetries of oxygen uptake transients at the on- and offset of heavy exercise in humans. *J. Physiol.* 443, 575–586.
- Poole, D.C., Jones, A.M., 2005. Towards an understanding of the mechanistic bases of \dot{V}_{O_2} kinetics. In: Jones, A.M., Poole, D.C. (Eds.), *Oxygen Uptake Kinetics in Sport, Exercise and Medicine*. Routledge, London and New York, pp. 298–328.
- Pringle, J.S., Doust, J.H., Carter, H., Tolfrey, K., Campbell, I.T., Sakkas, G.K., Jones, A.M., 2003a. Oxygen uptake kinetics during moderate, heavy and severe intensity "submaximal" exercise in humans: the influence of muscle fibre type and capillarisation. *Eur. J. Appl. Physiol.* 89, 289–300.
- Pringle, J.S., Doust, J.H., Carter, H., Tolfrey, K., Jones, A.M., 2003b. Effect of pedal rate on primary and slow-component oxygen uptake responses during heavy-cycle exercise. *J. Appl. Physiol.* 94, 1501–1507.
- Sargeant, A.J., 1999. Neuromuscular determinants of human performance. In: Whipp, B.J., Sargeant, A.J. (Eds.), *Physiological Determinants of Exercise Tolerance in Humans*. The Physiological Society, Portland Press, London, pp. 13–28.
- Whipp, B.J., Wasserman, K., 1972. Oxygen uptake kinetics for various intensities of constant-load work. *J. Appl. Physiol.* 33, 351–356.
- Whipp, B.J., Mahler, M., 1980. Dynamics of gas exchange during exercise. In: West, J.B. (Ed.), *Pulmonary Gas Exchange*, vol. II. Academic Press, New York, pp. 33–96.
- Whipp, B.J., Davis, J.A., Torres, F., Wasserman, K., 1981. A test to determine parameters of aerobic function during exercise. *J. Appl. Physiol.* 50, 217–221.
- Whipp, B.J., Ward, S.A., Lamarra, N., Davis, J.A., Wasserman, K., 1982. Parameters of ventilatory and gas exchange dynamics during exercise. *J. Appl. Physiol.* 52, 1506–1513.

Whipp, B.J., Rossiter, H., 2005. The kinetics of oxygen uptake: physiological inferences from the parameters. In: Jones, A.M., Poole, D.C. (Eds.), *Oxygen Uptake Kinetics in Sport, Exercise and Medicine*. Routledge, London and New York, pp. 62–94.

Wilkerson, D.P., Jones, A.M., 2006. Influence of initial metabolic rate on pulmonary O₂ uptake on-kinetics during severe intensity exercise. *Respir. Physiol. Neurobiol.* 152, 204–219.

Wilkerson, D.P., Jones, A.M., 2007. Effects of baseline metabolic rate on pulmonary O₂ uptake on-kinetics during heavy-intensity exercise in humans. *Respir. Physiol. Neurobiol.* 156, 203–211.

Zoladz, J.A., Gladden, L.B., Hogan, M.C., Nieckarz, Z., Grassi, B., 2008. Progressive recruitment of muscle fibres is not necessary for the slow component of \dot{V}_{O_2} kinetics. *J. Appl. Physiol.* 105, 575–580.

Influence of priming exercise on pulmonary O₂ uptake kinetics during transitions to high-intensity exercise at extreme pedal rates

Fred J. DiMenna,¹ Daryl P. Wilkerson,¹ Mark Burnley,² Stephen J. Bailey,¹ and Andrew M. Jones¹

¹School of Sport and Health Sciences, St. Luke's Campus, University of Exeter, Heavitree Road, Exeter, Devon;

and ²Department of Sport and Exercise Science, Aberystwyth University, Ceredigion, United Kingdom

Submitted 6 September 2008; accepted in final form 27 November 2008

DiMenna FJ, Wilkerson DP, Burnley M, Bailey SJ, Jones AM. Influence of priming exercise on pulmonary O₂ uptake kinetics during transitions to high-intensity exercise at extreme pedal rates. *J Appl Physiol* 106: 432–442, 2009. First published December 4, 2008; doi:10.1152/jappphysiol.91195.2008.—We investigated the pedal rate dependency of the effect of priming exercise on pulmonary oxygen uptake ($\dot{V}O_2$) kinetics. Seven healthy men completed two, 6-min bouts of high-intensity cycle exercise (separated by 6 min of rest) using different combinations of extreme pedal rates for the priming and criterion exercise bouts (i.e., 35→35, 35→115, 115→35, and 115→115 rev/min). Pulmonary gas exchange and heart rate were measured breath-by-breath, and muscle oxygenation was assessed using near-infrared spectroscopy. When the priming bout was performed at 35 rev/min (35→35 and 35→115 conditions), the phase II $\dot{V}O_2$ time constant (τ) was not significantly altered (*bout 1*: 31 ± 7 vs. *bout 2*: 30 ± 5 s and *bout 1*: 48 ± 16 vs. *bout 2*: 46 ± 21 s, respectively). However, when the priming bout was performed at 115 rev/min (115→35 and 115→115 conditions), the phase II τ was significantly reduced (*bout 1*: 31 ± 7 vs. *bout 2*: 26 ± 5 s and *bout 1*: 48 ± 16 vs. *bout 2*: 39 ± 9 s, respectively, $P < 0.05$). Muscle oxygenation was significantly higher after priming exercise in all four conditions, but significant effects on $\dot{V}O_2$ kinetics were only evident when muscle O₂ extraction (measured as $\Delta[\text{deoxyhemoglobin}]/\Delta\dot{V}O_2$) was elevated in the fundamental response phase. These data indicate that prior high-intensity exercise at a high pedal rate can speed $\dot{V}O_2$ kinetics during subsequent high-intensity exercise, presumably through specific priming effects on type II muscle fibers.

$\dot{V}O_2$ kinetics; phase II time constant; $\dot{V}O_2$ slow component; prior exercise; cadence

AN INITIAL BOUT OF HIGH-INTENSITY “priming” exercise profoundly alters the kinetics of pulmonary oxygen uptake ($\dot{V}O_2$) during a subsequent bout of high-intensity exercise (10, 20, 27). It has been established that priming results in faster “overall” $\dot{V}O_2$ kinetics, due principally to a marked reduction in the amplitude of the $\dot{V}O_2$ slow component, often in association with an increase in the amplitude of the fundamental $\dot{V}O_2$ response but normally with no effect on the phase II time constant (τ ; Refs. 5–9, 15, 19, 30, 32, 40, 47, 59).

The precise mechanism(s) responsible for the altered $\dot{V}O_2$ kinetics after priming remains to be resolved but might include changes in motor unit recruitment (5, 10), and/or O₂ availability (either increased bulk delivery consequent to greater blood flow or a more appropriate matching of regional distribution to active muscle fibers; Refs. 12, 20), and/or metabolic processes intrinsic to the involved fibers (e.g., increased activation of rate-limiting oxidative enzymes and/or greater concentration of

putative regulators of mitochondrial respiration; Refs 2, 23, 26). However, a priming effect is generally only observed when both the priming and criterion exercise bouts are performed at an intensity at which the blood lactate concentration ([lactate]) is elevated [i.e., above the gas exchange threshold (GET); Refs. 9, 20]. The Henneman “size principle” posits that skeletal muscle fibers are recruited in an orderly fashion with smaller, more oxidative (type I) fibers recruited first and larger, less oxidative (type II) fibers recruited as the requirement for muscle force production increases (22). Type II fibers possess slower $\dot{V}O_2$ kinetics and have lower contractile efficiency compared with type I fibers (3, 11, 55), and their recruitment has been suggested to be related to the development of the $\dot{V}O_2$ slow component during exercise above the GET (1, 25, 28, 34, 42, 52, 57). It is therefore reasonable to consider that priming exercise may exert its effects on $\dot{V}O_2$ kinetics (faster overall response and reduced $\dot{V}O_2$ slow component) during subsequent high-intensity exercise by influencing either the recruitment or the metabolic response of type II fibers.

The deoxyhemoglobin concentration ([HHb]) signal derived from near-infrared spectroscopy (NIRS) measurements reflects the balance between O₂ delivery and O₂ utilization in the field of interrogation and can be used to estimate O₂ extraction in the microcirculation during exercise (13, 18, 24, 59). There is evidence that both local O₂ availability and O₂ extraction are increased by priming exercise (12, 13, 24, 26). Slower $\dot{V}O_2$ kinetics in type II fibers have been attributed to a reduced microvascular pressure head for O₂ and the consequent requirement for greater fractional O₂ extraction to satisfy a given increase in metabolic demand (38). It is therefore possible that oxidative function in type II fibers could benefit more from the effects of priming than could oxidative function in type I fibers.

From the above, it is clear that the use of priming exercise in conjunction with interventions that might alter the proportional contribution of type II fibers to force production at the same relative exercise intensity could be a useful way to explore the mechanistic bases for the effect of priming exercise on $\dot{V}O_2$ kinetics. It is generally accepted that type II fiber contribution to force production is likely to be greater at very high pedal rates (16, 36, 46). However, previous investigations (5–9, 15, 19, 30–32, 47) that have examined the effect of priming exercise on $\dot{V}O_2$ kinetics during cycle exercise have generally employed midrange pedal rates during both the priming and criterion bouts (e.g., 60–90 rev/min).

We therefore investigated the potential pedal rate (and hence fiber-type recruitment) dependency of the effect of priming

Address for reprint requests and other correspondence: A. M. Jones, School of Sport and Health Sciences, St. Luke's Campus, Univ. of Exeter, Heavitree Road, Exeter, Devon, EX1 2LU UK (e-mail: a.m.jones@exeter.ac.uk).

The costs of publication of this article were defrayed in part by the payment of page charges. The article must therefore be hereby marked “advertisement” in accordance with 18 U.S.C. Section 1734 solely to indicate this fact.

exercise on $\dot{V}O_2$ kinetics by using different combinations of extreme pedal rates (35 and 115 rev/min) for the priming and criterion exercise bouts (i.e., 35→35, 35→115, 115→35, and 115→115 rev/min). We hypothesized that the characteristic effect of priming exercise (a reduced $\dot{V}O_2$ slow component and increased fundamental component amplitude with no change in the phase II τ) would be observed during transitions to high-intensity exercise at 35 rev/min, regardless of the cadence employed during the priming bout. We also hypothesized that similar effects would occur when priming exercise at 35 rev/min preceded exercise at 115 rev/min. In contrast, we hypothesized that a bout of prior exercise performed at 115 rev/min would reduce the phase II τ during subsequent exercise at 115 rev/min through specific effects on the higher order muscle fibers that would be expected to be recruited in both bouts.

METHODS

Subjects

Seven male subjects (means \pm SD; age: 31 \pm 8 yr, stature: 1.79 \pm 0.02 m, and mass: 81.5 \pm 7.5 kg) volunteered and gave written informed consent to participate in this study, which was approved by the University of Exeter Ethics Committee. The subjects were all recreationally active and were familiar with the exercise mode and experimental procedures used in the present study. On test days, subjects were instructed to report to the laboratory in a rested state, having completed no strenuous exercise within the previous 24 h and having abstained from food, alcohol, and caffeine for the preceding 3 h.

Experimental Overview

All testing was completed in an air-conditioned laboratory at a temperature of 20–22°C. The subjects visited the laboratory on 10 occasions over a 4-wk period to perform exercise tests on an electronically braked cycle ergometer (Lode Excalibur Sport, Groningen, The Netherlands). This device allows for the maintenance of a prescribed constant power output across a wide range of pedal cadences by instantaneously adjusting flywheel resistance via electrical braking.

Testing was conducted at the same time of day (\pm 2 h) for each subject. On each of the first two visits, the subjects completed a ramp incremental exercise test for determination of the cadence-specific peak $\dot{V}O_2$ ($\dot{V}O_{2peak}$) and GET. One test was performed at a pedal rate of 35 rev/min and the other at a pedal rate of 115 rev/min, and the test order was alternated between subjects. On each of the eight subsequent visits, subjects completed two bouts of high-intensity exercise (at a work rate calculated to require 60% of the difference between the GET and $\dot{V}O_{2peak}$; i.e., 60% “ Δ ”) separated by 6 min of complete rest. Two repetitions of each priming-/criterion-bout cadence combination (35→35, 35→115, 115→35, and 115→115) were performed, and the combinations were presented to subjects in random order. The initial bouts served as the unprimed control (35 unprimed and 115 unprimed). Each laboratory visit was separated by at least 48 h.

Experimental Procedures

The ramp incremental exercise tests consisted of 3 min of pedaling at 0 W, followed by a continuous ramped increase in work rate of 30 W/min until the subject was unable to continue. The subjects were asked to maintain the prescribed cadence, and instruction was given if/when they deviated by more than \pm 5 rev/min. Saddle and handlebar heights were recorded and the same settings were reproduced on subsequent tests. The $\dot{V}O_{2peak}$ was defined as the highest 30-s mean value recorded before the subject's volitional termination of the test.

The GET was determined from a cluster of measures including the following: 1) the first disproportionate increase in carbon dioxide output ($\dot{V}CO_2$) from visual inspection of individual plots of $\dot{V}CO_2$ vs. $\dot{V}O_2$; 2) an increase in $\dot{V}E/\dot{V}O_2$ (where $\dot{V}E$ is expiratory ventilation) with no increase in $\dot{V}E/\dot{V}CO_2$; and 3) an increase in end-tidal O₂ tension with no fall in end-tidal CO₂ tension. The work rates that would require 60% of the difference (Δ) between the cadence-specific GET and ($\dot{V}O_{2peak}$) were estimated for each cadence, with account taken of the mean response time of the $\dot{V}O_2$ response to ramp exercise (assumed to approximate two-thirds of the ramp rate, i.e., 20 W; Ref. 53). These work rates were subsequently applied during the constant work-rate protocols.

The subjects returned to the laboratory on eight occasions to perform 3 min of “unloaded” cycling at 20 W, 6 min of cycling at 60% Δ , 6 min of passive rest, 3 min of “unloaded” cycling at 20 W, and 6 min of cycling at 60% Δ . Two repetitions of each possible combination (35→35, 35→115, 115→35, and 115→115) were completed. This protocol provided data for transitions to high-intensity exercise at both 35 and 115 rev/min in the unprimed (4 repetitions) and primed (2 repetitions by 35 rev/min cycling and 2 repetitions by 115 rev/min cycling) states. Importantly, we chose not to adjust the baseline work rate to compensate for the greater cost of internal work at the higher cadence. This approach was used to better isolate the $\dot{V}O_2$ response dynamics of higher order fibers (14, 56, 57) and thus provide insight into the contribution made by these fibers under normal (midrange pedal rate) conditions (see Discussion for detail). The $\dot{V}O_2$ responses from like transitions were averaged before any analysis was performed to enhance the signal-to-noise ratio and improve confidence in the parameters derived from the model fits (35, 54).

During all tests, pulmonary gas exchange and ventilation were measured continuously using a portable metabolic cart (MetaMax 3B; Cortex Biophysik, Leipzig, Germany). A DVT turbine digital transducer measured inspired and expired airflow, while an electrochemical cell O₂ analyzer and ND infrared CO₂ analyzer simultaneously measured expired gases. Subjects wore a nose clip and breathed through a low-dead-space, low-resistance mouthpiece that was securely attached to the volume transducer. The inspired and expired gas volume and gas concentration signals were continuously sampled via a capillary line connected to the mouthpiece. The gas analyzers were calibrated before each test with gases of known concentration, and the turbine volume transducer was calibrated using a 3-l syringe (Hans Rudolph, Kansas City, MO). Pulmonary gas exchange and ventilation were calculated and displayed breath-by-breath. Heart rate (HR) was calculated over the duration of each breath during all tests using short-range radiotelemetry (Polar S610; Polar Electro Oy, Kempele, Finland). During one of the trials under each condition, a blood sample from a fingertip was collected into a capillary tube over the 20 s preceding the step transitions in work rate and within the last 20 s of exercise and subsequently analyzed to determine blood [lactate] (YSI 1500; Yellow Springs Instruments, Yellow Springs, OH). Blood lactate accumulation (Δ blood [lactate]) was calculated as the difference between blood [lactate] at end exercise and blood [lactate] at baseline.

The oxygenation status of the m. vastus lateralis of the right leg was monitored using a commercially available NIRS system (model NIRO 300; Hamamatsu Photonics KK, Hiugashi-ku, Japan). The system consisted of an emission probe that irradiates laser beams and a detection probe, which is positioned several centimeters from the emission probe in an optically dense rubber holder. Four different wavelength laser diodes provided the light source (776, 826, 845, and 905 nm), and the light returning from the tissue was detected by a photomultiplier tube in the spectrometer. The intensity of incident and transmitted light was recorded continuously at 2 Hz and used to estimate concentration changes from the resting baseline for oxygenated, deoxygenated, and total tissue hemoglobin. Therefore, the NIRS data represent a relative change based on the optical density measured in the first datum collected. The [HHb] signal can be regarded as being

essentially blood-volume insensitive during exercise and was therefore assumed to provide an estimate of changes in intramuscular oxygenation status and O₂ extraction in the field of interrogation (17). It is presently not possible to determine the relative contribution of myoglobin (Mb) to the total NIRS signal, but it is generally believed that this is relatively small (<10%; e.g., Ref. 49).

The leg was initially cleaned and shaved around the belly of the muscle, and the probes were placed in the holder that was secured to the skin with adhesive at 20 cm above the fibular head. To secure the holder and wires in place, an elastic bandage was wrapped around the subject's leg. The wrap helped to minimize the possibility that extraneous light could influence the signal and also ensured that the optodes did not move during exercise. Pen marks were made around the probes to enable reproduction of the placement in subsequent tests. The probe gain was set with the subject at rest in a seated position with the leg extended at downstroke on the cycle ergometer before the first exercise bout, and NIRS data were collected continuously throughout both bouts. The data were subsequently downloaded onto a personal computer, and the resulting text files were stored on a disk for later analysis.

Data Analysis Procedures

The breath-by-breath $\dot{V}O_2$ data from each test were initially examined to exclude errant breaths caused by coughing, swallowing, sighing, etc., and those values lying more than four SDs from the local mean were removed. The breath-by-breath data were subsequently linearly interpolated to provide second-by-second values, and, for each individual, identical repetitions were time aligned to the start of exercise and ensemble averaged. The first 20 s of data after the onset of exercise (i.e., the phase I response) were deleted (54) and a nonlinear least-square algorithm was used to fit the data, as described in the following biexponential equation:

$$\dot{V}O_2(t) = \dot{V}O_{2\text{baseline}} + A_p(1 - e^{-(t - TD_p)/\tau_p}) + A_s(1 - e^{-(t - TD_s)/\tau_s}) \quad (1)$$

where $\dot{V}O_2(t)$ represents the absolute $\dot{V}O_2$ at a given time t ; $\dot{V}O_{2\text{baseline}}$ represents the mean $\dot{V}O_2$ in the baseline period; A_p , TD_p , and τ_p represent the amplitude, time delay, and time constant, respectively, describing the phase II increase in $\dot{V}O_2$ above baseline; and A_s , TD_s , and τ_s represent the amplitude of, time delay before the onset of, and time constant describing the development of, the $\dot{V}O_2$ slow component, respectively. An iterative process was used to minimize the sum of the squared errors between the fitted function and the observed values. $\dot{V}O_{2\text{baseline}}$ was defined as the mean $\dot{V}O_2$ measured over the final 90 s of baseline pedaling. The end-exercise $\dot{V}O_2$ was defined as the mean $\dot{V}O_2$ measured over the final 30 s of exercise. The absolute fundamental component amplitude (Absolute A_p) was defined as the sum of $\dot{V}O_{2\text{baseline}}$ and A_p . Because the asymptotic value (A_s) of the exponential term describing the $\dot{V}O_2$ slow component may represent a higher value than is actually reached at the end of the exercise, the actual amplitude of the $\dot{V}O_2$ slow component at the end of exercise was defined as A_s . The amplitude of the slow component was also described relative to the entire $\dot{V}O_2$ response. In addition, the functional "gain" (G) of the fundamental $\dot{V}O_2$ response was computed by dividing A_p by the Δ work rate. The functional gain of the entire response (i.e., end-exercise "gain") was calculated in a similar manner.

To provide information on muscle oxygenation, we also modeled the [HHb] response to exercise. A biexponential model similar to that described in Eq. 1 was used, with the exception that the fitting window commenced at the onset of exercise (i.e., at $t = 0$). In addition to the fundamental [HHb] τ and TD derived from the biexponential fit, we also used the fundamental [HHb] amplitude to determine the $\Delta[\text{HHb}]/\Delta\dot{V}O_2$ during this phase of the response. This ratio indicates the degree of O₂ extraction required for a given increment in $\dot{V}O_2$ and can therefore provide insight into the dynamic balance between O₂ delivery and utilization when $\dot{V}O_2$ kinetics are altered. We also fit a single

exponential curve without time delay to the fundamental region of the HHb response, as indicated by the biexponential fit (i.e., fitting window constrained from $t = 0$ to the TD corresponding to the second exponential term). The "mean response time" (MRT) so derived provides an indication of overall [HHb] response dynamics during this initial phase of adaptation. We chose to express the [HHb] slow component both relative to the entire [HHb] response and as the $\Delta[\text{HHb}]/\Delta\dot{V}O_2$. The oxyhemoglobin concentration ([O₂Hb]) response does not approximate an exponential (12) and was therefore not modeled. However, we assessed priming-induced changes in [O₂Hb] by determining the average [O₂Hb] over the final 60 s of baseline pedaling before the exercise transition and the last 30 s of exercise.

We also modeled the HR response to exercise in each condition. For this analysis, data were linearly interpolated to provide second-by-second values and, for each individual, identical repetitions from like transitions were time aligned to the start of exercise and ensemble averaged. A nonlinear least-square monoexponential model without time delay was used to fit the data, with the fitting window commencing at $t = 0$ and constrained at the $\dot{V}O_2$ TD_s. The HR time constant (HR τ_p) so derived provides information on the overall HR response dynamics in the absence of any HR "slow component." We also used this fit to determine the magnitude of the HR slow component, which was calculated as the difference in HR between TD_s and the end of exercise.

Statistics

The parameters derived from the modeling of the $\dot{V}O_2$, [HHb], and HR data for each cadence were analyzed using one-way repeated measures ANOVA, with Fisher's least significant difference tests, as appropriate, to identify the location of statistically significant differences between the three conditions. Paired t -tests were used to compare parameters for 35 unprimed and 115 unprimed. Pearson product moment correlation coefficients were used to assess the relationship between changes in the $\dot{V}O_2$ τ_p after priming and differences in the $\dot{V}O_2$ τ_p for 35 unprimed compared with 115 unprimed, and also between the $\dot{V}O_2$ τ_p and the HR τ_p . Significance was accepted at $P < 0.05$. Results are reported as means \pm SD.

RESULTS

The $\dot{V}O_{2\text{peak}}$ of the subjects was not significantly different between pedal rates (41 ± 3 and 45 ± 6 ml·kg⁻¹·min⁻¹ at 35 and 115 rev/min, respectively, $P > 0.05$). However, the GET occurred at a higher percentage of $\dot{V}O_{2\text{peak}}$ at 115 rev/min (54 ± 5 compared with $42 \pm 7\%$; $P < 0.05$). Peak work rates attained in the incremental tests were 311 ± 17 and 318 ± 36 W, and the work rates calculated for 60% Δ were 211 ± 9 and 205 ± 26 W at 35 and 115 rev/min, respectively, (in both cases, $P > 0.05$).

Pedal Rate Effect

The $\dot{V}O_2$ response to 35 unprimed and 115 unprimed is illustrated for a representative subject in Fig. 1, and the response parameters are reported in Tables 1, 2, 3, and 4. During baseline cycling, $\dot{V}O_2$, HR, and blood [lactate] were significantly higher, and [O₂Hb] exhibited a greater reduction from resting values for 115 unprimed compared with 35 unprimed ($P < 0.05$ for all comparisons). The phase II $\dot{V}O_2$ τ (48 ± 16 vs. 31 ± 7 s) and the HR τ_p (51 ± 15 vs. 34 ± 9 s) were both significantly longer for 115 unprimed compared with 35 unprimed ($P < 0.05$). The A_p and G_p were both significantly lower for 115 unprimed compared with 35 unprimed ($P < 0.05$). The end-exercise $\dot{V}O_2$ was greater but the end-exercise gain was lower for 115 unprimed compared with 35

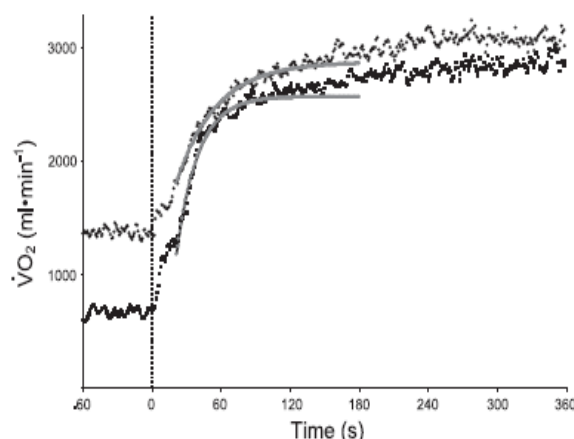

Fig. 1. Pulmonary O₂ uptake response after the onset of exercise during unprimed cycling at 35 and 115 rev/min in a representative subject. ■, 35 unprimed condition; ○, 115 unprimed condition. Solid lines through the data illustrate the phase II model fit. Vertical dashed line represents the abrupt transition to the higher work rate. Note that the phase II O₂ uptake kinetics are markedly slower at 115 rev/min.

unprimed ($P < 0.05$; Tables 3 and 4). The amplitude of the $\dot{V}O_2$ slow component was not significantly different between the two conditions, although the fractional contribution of the $\dot{V}O_2$ slow component to the total increase in $\dot{V}O_2$ above baseline tended to be greater at the higher pedal rate (17 ± 7 vs. $12 \pm 5\%$).

The fundamental phase [HHb] τ , MRT, and $\Delta[\text{HHb}]/\Delta\dot{V}O_2$ were all similar for 35 unprimed and 115 unprimed (Tables 1 and 2), but the [HHb] TD was shorter for 115 unprimed ($P < 0.05$). The [HHb] slow component and $\Delta[\text{HHb}]/\Delta\dot{V}O_2$ during the slow phase of the response were also similar (Tables 1 and 2).

Priming Effect

The priming exercise bouts performed at the two different pedal rates required a similar fraction of cadence-specific peak $\dot{V}O_2$ (35 rev/min: 88 ± 5 vs. 115 rev/min: $91 \pm 7\%$). In relation to the cadence-specific unprimed control, baseline blood [lactate] was significantly elevated in all primed bouts ($P < 0.01$;

Tables 1 and 2). Similarly, $\Delta\text{blood [lactate]}$ was significantly reduced in all primed bouts ($P < 0.05$) with the values for 35→35 and 115→35 being similar, and the values for 115→115 being significantly less than for 35→115 (Tables 1 and 2). In relation to the cadence-specific unprimed control, the baseline HR was also significantly elevated in all primed bouts ($P < 0.01$), but there was no significant difference between cadences. In all cases, this HR elevation persisted during exercise so that the end-exercise HR was significantly greater for all primed bouts. The end-exercise HR was similar for 35→115 and 115→115 but significantly greater for 115→35 compared with 35→35 ($P < 0.05$). Similarly, the baseline and end-exercise [O₂Hb] were significantly elevated in all primed bouts ($P < 0.05$), with no significant difference between conditions (Tables 1 and 2). The group mean total hemoglobin concentration ([Hb]), [O₂Hb], and [HHb] responses are presented in Fig. 2.

The parameters of the $\dot{V}O_2$ response in both the unprimed and primed states at each cadence are reported in Tables 3 and 4, and the group mean $\dot{V}O_2$ responses are illustrated in Fig. 3.

Thirty-five revolutions per minute. The baseline $\dot{V}O_2$ at 35 rev/min was significantly elevated by priming exercise at both cadences, but the effect was greater for 115→35 compared with 35→35 rev/min (Table 3). Prior exercise at 35 rev/min resulted in a significant increase in the absolute amplitude of the fundamental $\dot{V}O_2$ response and a significant reduction in the amplitude of the $\dot{V}O_2$ slow component, with no change in the phase II τ (31 ± 7 vs. 30 ± 5 s) during subsequent exercise at the same pedal rate. In contrast, prior exercise at 115 rev/min resulted in a significant increase in the absolute amplitude of the fundamental $\dot{V}O_2$ response, no significant change in the amplitude of the $\dot{V}O_2$ slow component, and a significant reduction in the phase II τ (31 ± 7 vs. 26 ± 5 s; $P < 0.05$).

One-hundred fifteen revolutions per minute. The baseline $\dot{V}O_2$ at 115 rev/min was significantly elevated when priming exercise was performed at 115 but not at 35 rev/min (Table 4). Prior exercise at 35 rev/min had no significant effects on $\dot{V}O_2$ kinetics, including the phase II τ (48 ± 16 vs. 46 ± 21 s) during subsequent exercise at 115 rev/min. However, prior exercise at 115 rev/min resulted in a significant reduction in the

Table 1. Blood [lactate] and heart rate and oxyhemoglobin and deoxyhemoglobin kinetics during 35 unprimed, 35→35, and 115→35

	35 Unprimed	35→35	115→35
Baseline blood [lactate], mM	0.7±0.3	2.3±0.9*	3.0±0.8*
End-exercise blood [lactate], mM	3.4±0.9	3.6±1.4	4.1±1.6
$\Delta\text{Blood [lactate]}$, mM	2.7±0.8	1.3±0.8*	1.2±1.6*
Baseline heart rate, beats/min	72±6	88±9*	93±11*
End-exercise heart rate, beats/min	140±11	147±13*	151±12*†
Heart rate τ_p , s	34±9	40±10	41±11
HR slow component, beats/min	12±8	7±7*	7±7*
Baseline [O ₂ Hb], AU	-13±62	79±72*	100±59*
End-exercise [O ₂ Hb], AU	-152±47	-79±47*	-84±72*
Primary phase [HHb] τ , s	14±2	16±5	16±5
Primary phase [HHb] time delay, s	6±3	5±1	5±2
Primary phase [HHb] mean response time, s	22±4	23±7	24±11
Primary phase $\Delta[\text{HHb}]/\Delta\dot{V}O_2$, AU·l ⁻¹ ·min ⁻¹	118±70	139±65*	141±64*
[HHb] slow component, %	20±7	8±4*	8±4*
Slow component $\Delta[\text{HHb}]/\Delta\dot{V}O_2$, AU·l ⁻¹ ·min ⁻¹	197±99	120±55	153±88

Values are means ± SD. 35 Unprimed, unprimed cycling at 35 rev/min; 35→35, 35 rev/min cycling primed by 35 rev/min cycling; 115→35, 35 rev/min cycling primed by 115 rev/min cycling; τ , time constant; τ_p , time constant for the phase II increase in $\dot{V}O_2$ above baseline; AU, arbitrary units. Brackets indicate concentration. *Significantly different from 35 Unprimed condition ($P < 0.05$). †Significantly different from 35→35 condition ($P < 0.05$).

Table 2. Blood [lactate] and heart rate and oxyhemoglobin and deoxyhemoglobin kinetics during 115 unprimed, 35→115, and 115→115

	115 Unprimed	35→115	115→115
Baseline blood [lactate], mM	0.9±0.2	2.3±0.8*	3.5±1.2*†
End-exercise blood [lactate], mM	5.2±1.0	5.5±0.7	5.3±1.5
Δ blood [lactate], mM	4.3±1.0	3.2±0.5*	1.8±0.7*†
Baseline heart rate, beats/min	100±7	113±9*	116±11*
End-exercise heart rate, beats/min	155±9	160±9*	160±12*
Heart rate τ _p , s	51±15	54±20	54±13
HR slow component, beats/min	9±6	4±5*	4±5*
Baseline [O ₂ Hb], AU	-61±72	29±45*	36±57*
End-exercise [O ₂ Hb], AU	-147±79	-55±75*	-69±61*
Primary phase [HHb] τ, s	14±7	14±6	13±8
Primary phase [HHb] time delay, s	3±1	3±2	3±1
Primary phase [HHb] mean response time, s	21±10	21±11	17±9
Primary phase Δ[HHb]/Δ $\dot{V}O_2$, AU·l ⁻¹ ·min ⁻¹	115±62	115±74	140±79*†
[HHb] slow component, %	28±12	25±16	17±12*
Slow component Δ[HHb]/Δ $\dot{V}O_2$, AU·l ⁻¹ ·min ⁻¹	198±69	197±98	175±107

Values are means ± SD. 115 Unprimed, unprimed cycling at 115 rev/min; 35→115, 115 rev/min cycling primed by 35 rev/min cycling; 115→115, 115 rev/min cycling primed by 115 rev/min cycling. *Significantly different from 115 unprimed condition ($P < 0.05$). †Significantly different from 35→115 condition ($P < 0.05$).

phase II τ (48 ± 16 vs. 39 ± 9 s; $P < 0.05$) with no change in the other kinetic parameters. The extent of the reduction in phase II τ after priming was correlated with the difference in phase II τ between 35 unprimed and 115 unprimed ($r = 0.93$; $P < 0.01$); no significant correlations existed for 35→35, 115→35, or 35→115.

There were no significant differences in the fundamental phase [HHb] kinetics parameters (τ, TD, or MRT) after priming at either cadence. The fundamental phase Δ[HHb]/Δ $\dot{V}O_2$ was significantly higher after priming for 35→35, 115→35, and 115→115 ($P < 0.05$) but not for 35→115. Similarly, the [HHb] slow component was reduced by priming in all conditions except for 35→115. There was no significant change in the Δ[HHb]/Δ $\dot{V}O_2$ during the slow component phase of the response after priming for any condition.

DISCUSSION

The principal finding of this investigation was that the effect of priming exercise on $\dot{V}O_2$ kinetics differed according to the combination of cadences employed in the priming and criterion bouts. Specifically, consistent with previous studies, priming at 35 rev/min altered the amplitudes of the $\dot{V}O_2$ fundamental and slow components during subsequent cycling at 35 rev/min without changing the phase II τ. In contrast, priming at 35 rev/min had no significant effect on $\dot{V}O_2$ kinetics during cy-

cling at 115 rev/min. However, the most striking effects occurred when the priming exercise was performed at 115 rev/min: with this intervention, the phase II τ was significantly reduced during subsequent exercise irrespective of the pedal rate employed. These unexpected results contribute significantly to our understanding of the mechanistic bases of the effects of priming exercise on $\dot{V}O_2$ kinetics by indicating that these effects are pedal-rate (and perhaps fiber-type recruitment) specific.

Manipulation of pedal rate at the same relative exercise intensity is potentially a useful way to explore the influence of muscle fiber type and motor unit recruitment on $\dot{V}O_2$ kinetics (28). Investigations have shown that the contribution of type II fibers may be greater at high movement frequencies (36, 46) and, correspondingly, studies that have compared $\dot{V}O_2$ kinetics at extreme pedal rates have reported a reduction in the gain of the fundamental component (1), an increase in the $\dot{V}O_2$ slow component (39, 43, 50), and a tendency for a longer phase II τ (43) at high compared with low cadences. These differences were attributed to an increased contribution of higher order (type II) fibers to force production at higher cadences. Type II fibers are believed to possess slower $\dot{V}O_2$ kinetics and have lower contractile efficiency than type I fibers (e.g., 3, 11, 28, 55).

Table 3. O₂ uptake kinetics during 35 unprimed, 35→35, and 115→35

	35 Unprimed	35→35	115→35
Baseline $\dot{V}O_2$, l/min	0.63±0.05	0.70±0.04*	0.74±0.07*†
Phase II τ, s	31±7	30±5	26±5*†
Phase II time delay, s	13±3	11±3	13±4
Fundamental phase amplitude, l/min	2.03±0.17	2.08±0.15	2.07±0.17
Fundamental phase gain, ml·min ⁻¹ ·W ⁻¹	10.6±0.5	10.9±0.5	10.8±0.6
Fundamental phase absolute amplitude, l/min	2.66±0.18	2.77±0.17*	2.81±0.22*
$\dot{V}O_2$ slow component time delay, s	139±48	146±41	149±66
$\dot{V}O_2$ slow component amplitude, l/min	0.27±0.10	0.20±0.06*	0.20±0.12
$\dot{V}O_2$ slow component relative amplitude, %	12±5	9±3*	9±5
End-exercise $\dot{V}O_2$, l/min	2.92±0.12	2.97±0.12	3.00±0.21
End-exercise gain, ml·min ⁻¹ ·W ⁻¹	12.0±0.4	11.9±0.3	11.8±0.4

Values are means ± SD. *Significantly different from 35 Unprimed condition ($P < 0.05$). †Significantly different from 35→35 condition ($P < 0.05$).

Table 4. O₂ uptake kinetics during 115 unprimed, 35→115, and 115→115

	115 Unprimed	35→115	115→115
Baseline $\dot{V}O_2$, l/min	1.55±0.22	1.61±0.24	1.66±0.23*
Phase II τ , s	48±16	46±21	39±9*
Phase II time delay, s	8±3	6±11	9±3
Fundamental phase amplitude, l/min	1.44±0.21	1.42±0.29	1.38±0.21
Fundamental phase gain, ml·min ⁻¹ ·W ⁻¹	7.8±0.7	7.7±1.2	7.5±0.8
Fundamental phase absolute amplitude, l/min	2.99±0.29	3.04±0.24	3.04±0.34
$\dot{V}O_2$ slow component time delay, s	146±27	138±44	135±37
$\dot{V}O_2$ slow component amplitude, l/min	0.30±0.13	0.25±0.14	0.21±0.10
$\dot{V}O_2$ slow component relative amplitude, %	17±7	15±9	13±6
End-exercise $\dot{V}O_2$, l/min	3.27±0.31	3.29±0.27	3.25±0.32
End-exercise gain, ml·min ⁻¹ ·W ⁻¹	9.3±0.8	9.0±0.8	8.6±0.7*†

Values are means ± SD. *Significantly different from 115 unprimed condition ($P < 0.05$). †Significantly different from 35→115 condition ($P < 0.05$).

For dynamic contractions at a given power output, oxygen uptake is greater at high compared with low contraction frequencies due to the greater cost of internal work and also to a higher rate of energy turnover (1, 16, 51). In previous investigations into the effect of pedal rate on $\dot{V}O_2$ kinetics, high-intensity cycle transitions have been initiated either from complete rest (50) or from baseline work rates that have been adjusted to compensate for the increased O₂ cost of unloaded cycling at the highest cadence (1, 43). However, high-intensity cycle transitions from an elevated baseline metabolic rate (work-to-work transitions) are characterized by slower phase II $\dot{V}O_2$ kinetics, a reduced $\dot{V}O_2$ slow component, and a greater total response gain compared with transitions initiated from a baseline of unloaded cycling (14, 56, 57). It has been suggested that such work-to-work transitions functionally isolate the metabolic response characteristics of muscle fibers that are positioned higher in the recruitment hierarchy (4, 14, 56, 57). Therefore, it is possible that the matching of baseline $\dot{V}O_2$ in earlier studies masked some of the differences in $\dot{V}O_2$ kinetics that exist at extreme pedal rates. In the present study, we deliberately employed transitions from the same 20-W baseline for both cadences so that energy turnover during baseline cycling would be greater at 115 rev/min and the differences between the response characteristics of lower- and higher order fibers at the different pedal rates would be amplified.

Effects of Pedal Rate on $\dot{V}O_2$ Kinetics in the Control (Unprimed) Condition

A novel observation in the present study was that the phase II $\dot{V}O_2$ τ was significantly longer for 115 unprimed compared with 35 unprimed. The HR τ_p was also significantly longer at the higher pedal rate, which might be interpreted to indicate that limited blood flow (and, by extension, O₂ delivery) was responsible for the slower phase II $\dot{V}O_2$ kinetics observed at 115 unprimed compared with 35 unprimed. However, Ferguson et al. (16) have reported that muscle blood flow was actually higher at a contraction frequency of 100 compared with 60 kicks/min during knee extension exercise. Moreover, Ferreira et al. (18) have shown a similar [HHb] profile (assessed using NIRS) throughout incremental cycle exercise at 100 compared with 60 rev/min and, in the present study, the fundamental phase $\Delta[\text{HHb}]/\Delta\dot{V}O_2$ was similar for 35 unprimed and 115 unprimed. Similar O₂ extraction (as indicated by the [HHb] response) would not be expected if bulk O₂ delivery kinetics were limiting muscle O₂ uptake at faster pedal rates.

Slower phase II $\dot{V}O_2$ kinetics could also be an indication of a limited capacity for the recruited muscle fibers to utilize the available O₂. Higher order fibers typically possess higher total creatine content, a greater propensity for substrate-level phosphorylation, a lower oxidative capacity, a reduced microvascular pressure head for O₂, and slower $\dot{V}O_2$ kinetics compared with lower order fibers (3, 11, 38, 44, 60). Therefore, it is possible that the slower phase II $\dot{V}O_2$ kinetics we observed at 115 unprimed compared with 35 unprimed reflected the oxidative metabolic properties of the population of muscle fibers that were principally activated. However, it is also possible that regional heterogeneities of perfusion relative to metabolic rate (3, 45) were exacerbated when the contribution of higher order fibers to force production was increased at the higher cadence.

Effects of Priming on $\dot{V}O_2$ Kinetics at Extreme Pedal Rates

A large number of previous studies have identified the characteristic effects of priming exercise (i.e., a marked attenuation of the $\dot{V}O_2$ slow component, often with an associated increase in the amplitude of the phase II $\dot{V}O_2$ response, but with no change in the phase II τ) during upright cycle exercise in healthy young humans (e.g., 5–9, 15, 19, 24, 27, 30–32, 40, 47, 59). In some instances, reductions in the phase II τ have also been reported, but generally only when the phase II τ value is large (i.e., the kinetic adaptation is slow) in the control condition (21, 24, 31, 48). However, previous investigations have typically employed midrange pedal rates (e.g., 70–90 rev/min) for both the priming and criterion exercise bouts. In the present study, we elected to use extreme pedal rates (35 and 115 rev/min) in both the priming and criterion exercise bouts to investigate the potential fiber-type dependency of the effect of priming exercise on $\dot{V}O_2$ kinetics.

Consistent with our hypothesis and in agreement with previous observations at midrange pedal rates, priming at 35 rev/min reduced the amplitude of the $\dot{V}O_2$ slow component and increased the fundamental component amplitude but did not alter the phase II τ during subsequent cycling at 35 rev/min. Priming exercise (particularly when of high intensity and resulting in a metabolic acidosis) would be expected to result in muscle vasodilatation and a rightward shift of the oxyhemoglobin dissociation curve and thus to increase both convective and diffusive components of muscle O₂ delivery (20). Indeed, priming has been shown to increase cardiac output, muscle blood flow, and muscle oxygenation before and during subsequent exercise (5, 13, 19, 26, 33, 59). Therefore, the

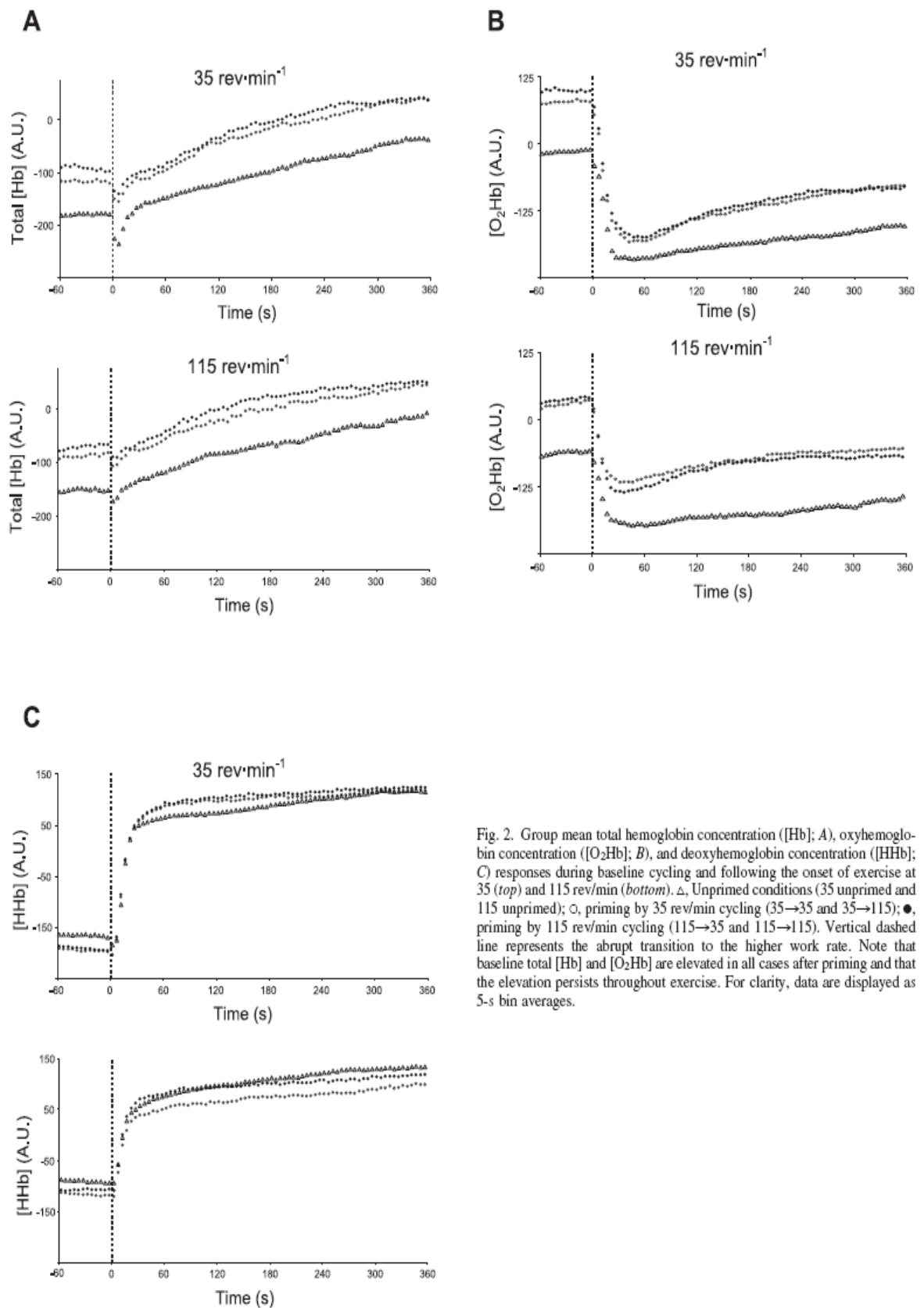

Fig. 2. Group mean total hemoglobin concentration ([Hb]; A), oxyhemoglobin concentration ([O₂Hb]; B), and deoxyhemoglobin concentration ([HHb]; C) responses during baseline cycling and following the onset of exercise at 35 (top) and 115 rev/min (bottom). Δ , Unprimed conditions (35 unprimed and 115 unprimed); \circ , priming by 35 rev/min cycling (35→35 and 35→115); \bullet , priming by 115 rev/min cycling (115→35 and 115→115). Vertical dashed line represents the abrupt transition to the higher work rate. Note that baseline total [Hb] and [O₂Hb] are elevated in all cases after priming and that the elevation persists throughout exercise. For clarity, data are displayed as 5-s bin averages.

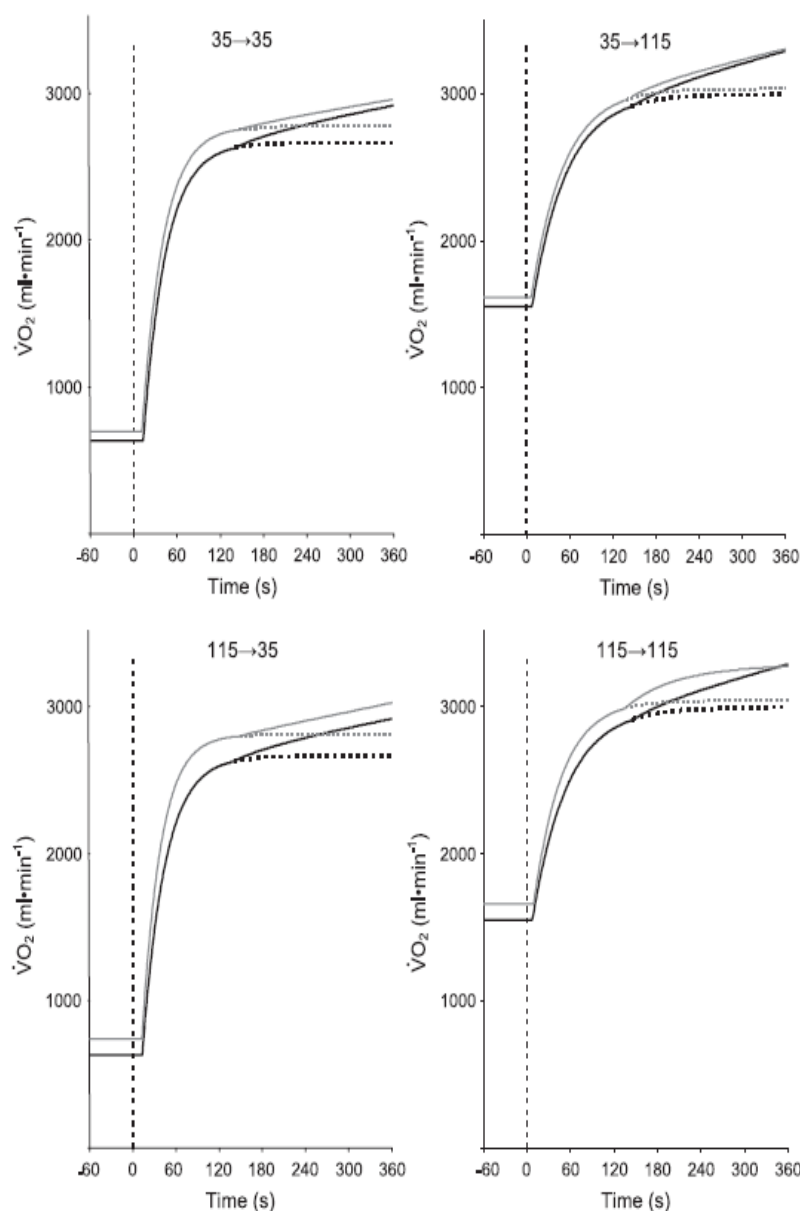

Fig. 3. Group mean pulmonary O₂ uptake response after the onset of exercise during unprimed and primed cycling at 35 (left) and 115 (right) rev/min. Black line represents the response observed in the unprimed condition; grey line represents the response observed in the primed condition (top: priming by 35 rev/min; bottom: priming by 115 rev/min). Horizontal dashed lines represent the asymptote of the fundamental component. Vertical dashed line represents the abrupt transition to the higher work rate. Note that the effect of priming exercise on $\dot{V}O_2$ kinetics differed according to the combination of cadences used in the priming and criterion bouts.

priming effect we observed for 35→35 might have been caused by increased muscle O₂ availability. However, $\dot{V}O_2$ kinetics were not significantly altered for 35→115, despite significant elevations of blood [lactate], HR, and [O₂Hb], suggesting that factors other than changes in bulk O₂ delivery might have been responsible for the priming effects observed. Another explanation for the changes in the amplitudes of the fundamental and slow components of $\dot{V}O_2$ in the 35→35 condition is that priming alters motor unit recruitment in the second compared with the first bout of high-intensity exercise. Support for this notion comes from Burnley et al. (5), who reported an increase in leg muscle integrated electromyogram during the first 2 min of high-intensity cycle exercise after priming in association with an increased phase II amplitude and decreased $\dot{V}O_2$ slow component. The authors suggested that priming increased motor unit recruitment at the onset of subsequent exercise, which allowed the phase II amplitude to project to a value that was

closer to what was required later in the bout. If this phenomenon depends on the involved fibers having experienced a recent (e.g., within 45 min; Ref. 8) exercise bout involving similar motor unit recruitment patterns, it could perhaps explain the lack of effect for 35→115 despite the completion of an identical priming bout and the similar residual effects on blood [lactate], HR, and [O₂Hb]. The lack of effect on $\dot{V}O_2$ kinetics when priming exercise at 35 rev/min preceded exercise at 115 rev/min was not expected and might indicate that the priming bout was not sufficiently specific to invoke the anticipated changes in the $\dot{V}O_2$ response to the subsequent exercise at the much higher pedal rate.

In accordance with our hypothesis, priming at 115 rev/min reduced the phase II τ but did not alter the $\dot{V}O_2$ fundamental or slow component amplitudes during cycling at 115 rev/min. This result is in agreement with a number of previous investigations of priming exercise where the phase II τ was large in

the control condition. For example, the phase II τ was reduced after priming during supine cycling (unprimed τ , ~38 s; Ref. 24), during arm crank exercise with the arms above heart level (unprimed τ , ~50 s; Ref. 30), and in older subjects during moderate-intensity cycling (unprimed τ , ~50 s; Ref. 48). However, in these investigations, O₂ delivery in the control condition was likely constrained (due to body position and age-related changes in the blood flow adaptation to exercise, respectively) and the effect could be attributed, in part, to improved muscle perfusion and O₂ delivery after priming. In the present study, it is less likely that the lengthened phase II τ observed for 115 unprimed (~48 s) was due to restricted O₂ supply [see *Effects of Pedal Rate on $\dot{V}O_2$ Kinetics in the Control (Unprimed) Condition*]. Moreover, the significant elevation of baseline HR and [O₂Hb] in the 35→115 condition did not result in the same speeding of $\dot{V}O_2$ kinetics that was observed for 115→115. These results suggest that the priming effect we observed for 115→115 originated within the involved myocytes (e.g., priming of intramuscular oxidative mechanisms that allowed the O₂ being delivered to be used more rapidly; see also *Effects of Priming on Muscle Oxygenation at Extreme Pedal Rates*). In this respect, the increased O₂ availability afforded by the performance of prior exercise could be said to have facilitated, rather than caused, the reduction in the phase II τ observed (12, 27). It is also possible, however, that regional heterogeneities of perfusion relative to metabolic rate (38, 45) were alleviated only when higher order fibers were previously activated at high contraction frequencies.

An unexpected result from the present study was that, contrary to our hypothesis, the effect of priming at 115 rev/min was to reduce the phase II $\dot{V}O_2$ τ during subsequent cycling at 35 rev/min. This latter result was surprising because the τ in the control condition at 35 rev/min was not unusually long (~31 s). However, type II fibers would still be expected to be involved in a transition to high-intensity exercise even at a very low cadence such as 35 rev/min. If priming at the faster cadence was necessary to accelerate $\dot{V}O_2$ kinetics in these fibers, this would explain the reduced phase II τ in both the 115→35 and 115→115 conditions, as well as the lack of effect for 35→35 and 35→115 in the present study and also in previous studies where midrange pedal rates were used for priming. Although speculative, our results imply that a reduction in the phase II τ during high-intensity upright cycle exercise is possible when the priming exercise bout necessitates a significant contribution of type II fibers to force production. The precise mechanism responsible for the effects observed cannot be ascertained from the present data but prior engagement of these higher order fibers might be expected to increase O₂ supply and/or the activity of rate-limiting enzymes in the oxidative chain or to alter motor unit recruitment thresholds when these same fibers are recruited during subsequent exercise (10, 23, 27, 41).

Effects of Priming on Muscle Oxygenation at Extreme Pedal Rates

The NIRS data indicated that total [Hb] and [O₂Hb] were increased in the area of interrogation as a consequence of priming exercise. Notably, the kinetic parameters (TD, τ , and MRT) for the adjustment of [HHb] during exercise were not significantly altered by priming, indicating that muscle O₂

delivery was well matched to the requirements in the early minutes of exercise. DeLorey et al. (13) suggested that the observation of a slower rate of [HHb] adaptation in conjunction with a reduced phase II τ in older adults provided evidence that an O₂ delivery limitation in the control condition had been alleviated by priming exercise. In contrast, in the present study, the rate of [HHb] adaptation was not different in those conditions in which the phase II τ was reduced by priming. Our data are consistent with Jones et al. (26) and DeLorey et al. (12) in showing that the [HHb] MRT is not altered by prior exercise but differ from the data of Marles et al. (37) in which the [HHb] MRT was significantly reduced. However, the Δ [HHb]/ $\Delta\dot{V}O_2$, which might be used to infer muscle O₂ extraction, over the fundamental phase of the response was significantly increased for 35→35, 115→35, and 115→115, although not for 35→115. Interestingly, 35→115 was also the only condition where there was no effect of priming on $\dot{V}O_2$ kinetics. An increased fundamental phase Δ [HHb]/ $\Delta\dot{V}O_2$ after priming has been reported previously (12) and is indicative of a greater proportional contribution of O₂ extraction to satisfy a given increase in $\dot{V}O_2$. The data therefore indicate that enhanced $\dot{V}O_2$ kinetics after priming exercise was contingent upon the involved muscle fibers having an improved ability to utilize the available O₂; when greater O₂ extraction was not achieved (during the 35→115 condition), $\dot{V}O_2$ kinetics were not altered despite O₂ availability being increased to a similar extent as for the other three conditions. One interpretation is that, in the 35→115 condition, type II fibers recruited in the second exercise bout were not sufficiently "primed" by the initial exercise bout.

The [HHb] slow component was significantly reduced for 35→35, 115→35, and 115→115 (in which $\dot{V}O_2$ kinetics were altered), although not for 35→115 (in which $\dot{V}O_2$ kinetics were unchanged). In keeping with earlier studies (26, 37), there was limited agreement between changes in the $\dot{V}O_2$ slow component and changes in the [HHb] slow component after prior exercise. This might not be considered surprising given that the rising $\dot{V}O_2$ during the slow phase of the response could be satisfied by increased muscle O₂ delivery, increased O₂ extraction, or both. However, the Δ [HHb]/ $\Delta\dot{V}O_2$ in the slow phase of the response was not significantly altered by prior exercise, suggesting that changes in [HHb] and $\dot{V}O_2$ were generally proportional, and that reductions in the $\dot{V}O_2$ slow component with priming might be associated with increased muscle O₂ availability, as has been previously suggested (58).

Some methodological issues with regard to the NIRS measurements in the present study should be highlighted. It is not clear whether changes in NIRS optical parameters such as the differential path length factor and the degree of light scattering occur during constant-work-rate exercise, during repeated bouts of exercise, and at different pedal rates. This makes it difficult to confidently quantify absolute changes in O₂ extraction resulting from any intervention. However, the available evidence suggests that differences in scattering between the pedal rates will be minimal at the wavelengths used in the present study (18). We expressed the Δ [HHb] data for the two pedal rates relative to the resting baseline value. The amplitude values within conditions showed good reproducibility on different days (unpublished observations) and therefore differences between conditions might be expected to have a physiological origin; this remains to be confirmed, however. It

should also be noted that the NIRS data only reflect changes within the superficial area of muscle under interrogation and as such may not be representative of the entire muscle mass. Moreover, our NIRS measurements were made at only one location, and it is known that the dynamics of muscle oxygenation express significant heterogeneity at different locations across the quadriceps muscles of healthy subjects after the onset of exercise (29).

In animal models, both Hogan (23) and Behnke et al. (2) have reported that prior contractile activity resulted in faster activation of muscle oxidative metabolism during subsequent contractions. It is unclear why pulmonary $\dot{V}O_2$ measurements only rarely demonstrate a similar effect in exercising humans (i.e., a reduced phase II τ after priming). One possibility is that the characteristic alteration in the proportional contribution of the fundamental and slow components to the total $\dot{V}O_2$ response after priming at midrange pedal rates reflects the conflation of two different priming-related phenomena. The $\dot{V}O_2$ slow component might reflect an increased activation of fibers (lower and/or higher order) as exercise proceeds (34) and/or slower $\dot{V}O_2$ kinetics of higher order fibers recruited at or close to exercise onset (57). In addition to altering the motor unit activation patterns during subsequent exercise (5), priming might accelerate oxidative phosphorylation in these fibers such that they reach (or project towards) their individual "steady-state" $\dot{V}O_2$ values more rapidly (2, 23). However, during exercise transitions typically used in priming investigations (i.e., transitions to high-intensity exercise from very low metabolic rates at midrange pedal rates), these two effects might be indistinguishable (i.e., the speeding of $\dot{V}O_2$ kinetics in higher order fibers might appear as an amplitude shift from slow to fundamental phase because the phase II response is primarily established by low-order fibers with faster kinetics). In the present study, the distinctly different effects we observed for 35→35 and 115→115 might indicate that the use of extreme pedal rates and the difference in the baseline metabolic rate allowed us to differentiate between these two different priming-induced alterations.

In conclusion, we have shown that despite similar elevations in HR and [O₂Hb] after priming, the effect of prior high-intensity exercise on $\dot{V}O_2$ kinetics during subsequent high-intensity exercise differed according to the combination of pedal rates employed in the priming and criterion bouts. When the priming and criterion exercise bouts were completed at the same low pedal rate, the "classical" effects of elevated fundamental component $\dot{V}O_2$ and reduced $\dot{V}O_2$ slow component with no effect on the phase II τ were observed; when the priming bout involved a low pedal rate, no effects on $\dot{V}O_2$ kinetics during subsequent exercise at a high pedal rate were measured; however, when the priming bout involved a high pedal rate, the phase II τ was significantly reduced during subsequent exercise irrespective of the pedal rate employed. Significant effects on $\dot{V}O_2$ kinetics after priming were only evident when muscle O₂ extraction (measured as $\Delta[\text{HHb}]/\Delta\dot{V}O_2$) was elevated. These data indicate that factors intrinsic to the recruited muscle fibers might be responsible for mediating the alterations in $\dot{V}O_2$ kinetics that attend the performance of priming exercise.

REFERENCES

1. Barstow TJ, Jones AM, Nguyen H, Casaburi R. Influence of muscle fiber type and pedal frequency on oxygen uptake kinetics of heavy exercise. *J Appl Physiol* 81: 1642–1650, 1996.
2. Behnke BJ, Kindig CA, Musch TI, Sexton WL, Poole DC. Effects of prior contractions on muscle microvascular oxygen pressure at onset of subsequent contractions. *J Physiol* 539: 927–934, 2002.
3. Behnke BJ, McDonough P, Padilla DJ, Musch TI, Poole DC. Oxygen exchange profile in rat muscles of contrasting fibre types. *J Physiol* 549: 597–605, 2003.
4. Brittain CJ, Rossiter HB, Kowalchuk JM, Whipp BJ. Effect of prior metabolic rate on the kinetics of oxygen uptake during moderate-intensity exercise. *Eur J Appl Physiol* 86: 125–134, 2001.
5. Burnley M, Doust JH, Ball D, Jones AM. Effects of prior heavy exercise on $\dot{V}O_2$ kinetics during heavy exercise are related to changes in muscle activity. *J Appl Physiol* 93: 167–174, 2002.
6. Burnley M, Doust JH, Carter H, Jones AM. Effects of prior exercise and recovery duration on oxygen uptake kinetics during heavy exercise in humans. *Exp Physiol* 86: 417–425, 2001.
7. Burnley M, Doust JH, Jones AM. Effects of prior heavy exercise, prior sprint exercise and passive warming on oxygen uptake kinetics during heavy exercise in humans. *Eur J Appl Physiol* 87: 424–432, 2002.
8. Burnley M, Doust JH, Jones AM. Time required for the restoration of normal heavy exercise $\dot{V}O_2$ kinetics following prior heavy exercise. *J Appl Physiol* 101: 1320–1327, 2006.
9. Burnley M, Jones AM, Carter H, Doust JH. Effects of prior heavy exercise on phase II pulmonary oxygen uptake kinetics during heavy exercise. *J Appl Physiol* 89: 1387–1396, 2000.
10. Burnley M, Koppo K, Jones AM. "Priming exercise" and $\dot{V}O_2$ kinetics. In *Oxygen Uptake Kinetics in Sport, Exercise and Medicine*, edited by Jones AM and Poole DC. London: Routledge, p. 230–260, 2005.
11. Crow MT, Kushmerick MJ. Chemical energetics of slow- and fast-twitch muscles of the mouse. *J Gen Physiol* 79: 147–166, 1982.
12. DeLorey DS, Kowalchuk JM, Heenan AP, duManoir GR, Paterson DH. Prior exercise speeds pulmonary O₂ uptake kinetics by increases in both local muscle O₂ availability and O₂ utilization. *J Appl Physiol* 103: 771–778, 2007.
13. DeLorey DS, Kowalchuk JM, Paterson DH. Effects of prior heavy-intensity exercise on pulmonary O₂ uptake and muscle deoxygenation kinetics in young and older adult humans. *J Appl Physiol* 97: 998–1005, 2004.
14. DiMenna FJ, Wilkerson DP, Burnley M, Jones AM. Influence of priming exercise on pulmonary O₂ uptake kinetics during transitions to high-intensity exercise from an elevated baseline. *J Appl Physiol* 105: 538–546, 2008.
15. Endo M, Okada Y, Rossiter HB, Ooue A, Miura A, Koga S, Fukuba Y. Kinetics of pulmonary $\dot{V}O_2$ and femoral artery blood flow and their relationship during repeated bouts of heavy exercise. *Eur J Appl Physiol* 95: 418–430, 2005.
16. Ferguson RA, Ball D, Krstrup P, Aagaard P, Kjaer M, Sargeant AJ, Hellsten Y, Bangsbo J. Muscle oxygen uptake and energy turnover during dynamic exercise at different contraction frequencies in humans. *J Physiol* 536: 261–271, 2001.
17. Ferrari M, Binzoni T, Quaresima V. Oxidative metabolism in muscle. *Philos Trans R Soc Lond B Biol Sci* 352: 677–683, 1997.
18. Ferreira LF, Lutjemeier BJ, Townsend DK, Barstow TJ. Effects of pedal frequency on estimated muscle microvascular O₂ extraction. *Eur J Appl Physiol* 96: 558–563, 2006.
19. Fukuba Y, Hayashi N, Koga S, Yoshida T. $\dot{V}O_2$ kinetics in heavy exercise is not altered by prior exercise with a different muscle group. *J Appl Physiol* 92: 2467–2474, 2002.
20. Gerbino A, Ward SA, Whipp BJ. Effects of prior exercise on pulmonary gas-exchange kinetics during high-intensity exercise in humans. *J Appl Physiol* 80: 99–107, 1996.
21. Gurd BJ, Scheuermann BW, Paterson DH, Kowalchuk JM. Prior heavy-intensity exercise speeds $\dot{V}O_2$ kinetics during moderate-intensity exercise in young adults. *J Appl Physiol* 98: 1371–1378, 2005.
22. Henneman E, Mendell LM. Functional organization of motoneuron pool and its inputs. In: *Handbook of Physiology. Nervous System, Motor Control, Part 1*. Bethesda, MD: Am Physiol Soc, 1981, vol. 2, sect. 1, p. 423–507.

23. Hogan MC. Fall in intracellular PO₂ at the onset of contractions in *Xenopus* single skeletal muscle fibers. *J Appl Physiol* 90: 1871–1876, 2001.
24. Jones AM, Berger NJ, Wilkerson DP, Roberts CL. Effects of “priming” exercise on pulmonary O₂ uptake and muscle deoxygenation kinetics during heavy-intensity cycle exercise in the supine and upright positions. *J Appl Physiol* 101: 1432–1441, 2006.
25. Jones AM, Campbell IT, Pringle JS. Influence of muscle fibre type and pedal rate on the V_{O₂}-work rate slope during ramp exercise. *Eur J Appl Physiol* 91: 238–245, 2004.
26. Jones AM, Fulford J, Wilkerson DP. Influence of prior exercise on muscle [phosphorylcreatine] and deoxygenation kinetics during high-intensity exercise in men. *Exp Physiol* 93: 468–478, 2008.
27. Jones AM, Koppo K, Burnley M. Effects of prior exercise on metabolic and gas exchange responses to exercise. *Sports Med* 33: 949–971, 2003.
28. Jones AM, Pringle JSM, Carter H. Influence of muscle fibre type and motor unit recruitment on V_{O₂} kinetics. In: *Oxygen Uptake Kinetics in Sport, Exercise and Medicine*, edited by Jones AM and Poole DC. London: Routledge, 2005, p. 261–293.
29. Koga S, Poole DC, Ferreira LF, Whipp BJ, Kondo N, Saitoh T, Ohmae E, Barstow TJ. Spatial heterogeneity of quadriceps muscle deoxygenation kinetics during cycle exercise. *J Appl Physiol* 103: 2049–2056, 2007.
30. Koppo K, Bouckaert J. The effect of prior high-intensity cycling exercise on the V_{O₂} kinetics during high-intensity cycling exercise is situated at the additional slow component. *Int J Sports Med* 22: 21–26, 2001.
31. Koppo K, Bouckaert J. Prior arm exercise speeds the V_{O₂} kinetics during arm exercise above the heart level. *Med Sci Sports Exerc* 37: 613–619, 2005.
32. Koppo K, Jones AM, Bouckaert J. Effect of prior heavy arm and leg exercise on V_{O₂} kinetics during heavy leg exercise. *Eur J Appl Physiol* 88: 593–600, 2003.
33. Krstrup P, Gonzalez-Alonso J, Quistorff B, Bangsbo J. Muscle heat production and anaerobic energy turnover during repeated intense dynamic exercise in humans. *J Physiol* 536: 947–956, 2001.
34. Krstrup P, Soderlund K, Mohr M, Bangsbo J. The slow component of oxygen uptake during intense, sub-maximal exercise in man is associated with additional fibre recruitment. *Pflügers Arch* 447: 855–866, 2004.
35. Lamarra N, Whipp BJ, Ward SA, Wasserman K. Effect of interbreath fluctuations on characterizing exercise gas exchange kinetics. *J Appl Physiol* 62: 2003–2012, 1987.
36. MacIntosh BR, Neptune RR, Horton JF. Cadence, power, and muscle activation in cycle ergometry. *Med Sci Sports Exerc* 32: 1281–1287, 2000.
37. Marles A, Perrey S, Legrand R, Blondel N, Delangles A, Betbeder D, Mucci P, Prieur F. Effect of prior heavy exercise on muscle deoxygenation kinetics at the onset of subsequent heavy exercise. *Eur J Appl Physiol* 99: 677–684, 2007.
38. McDonough P, Behnke BJ, Padilla DJ, Musch TI, Poole DC. Control of microvascular oxygen pressures in rat muscles comprised of different fiber types. *J Physiol* 563: 903–913, 2005.
39. Migita T, Hirakoba K. Effects of different pedal rates on oxygen uptake slow component during constant-load cycling exercise. *J Sports Med Phys Fitness* 46: 189–196, 2006.
40. Perrey S, Scott J, Mouro L, Rouillon JD. Cardiovascular and oxygen uptake kinetics during sequential heavy cycling exercises. *Can J Appl Physiol* 28: 283–298, 2003.
41. Poole DC, Barstow TJ, McDonough P, Jones AM. Control of oxygen uptake during exercise. *Med Sci Sports Exerc* 40: 462–474, 2008.
42. Pringle JS, Doust JH, Carter H, Tolfrey K, Campbell IT, Sakkas G, Jones AM. Oxygen uptake kinetics during moderate, heavy and severe intensity “submaximal” exercise in humans: the influence of muscle fibre type and capillarisation. *Eur J Appl Physiol* 89: 289–300, 2003.
43. Pringle JS, Doust JH, Carter H, Tolfrey K, Jones AM. Effect of pedal rate on primary and slow-component oxygen uptake responses during heavy-cycle exercise. *J Appl Physiol* 94: 1501–1507, 2003.
44. Reggiani C, Potma EJ, Bottinelli R, Canepari M, Pellegrino MA, Stienen GJM. Chemo-mechanical energy transduction in relation to myosin isoform composition in skeletal muscle fibres of the rat. *J Physiol* 502: 449–460, 1997.
45. Richardson RS, Haseler LJ, Nygren AT, Bluml S, Frank LR. Local perfusion and metabolic demand during exercise: a noninvasive MRI method of assessment. *J Appl Physiol* 91: 1845–1853, 2001.
46. Sargeant AJ. Neuromuscular determinants of human performance. In: *Physiological Determinants of Exercise Tolerance in Humans*, edited by Whipp BJ and Sargeant AJ. London: The Physiological Society, Portland, 1999, p. 13–28.
47. Scheuermann BW, Hoelting BD, Noble ML, Barstow TJ. The slow component of O₂ uptake is not accompanied by changes in muscle EMG during repeated bouts of heavy exercise in humans. *J Physiol* 531: 245–256, 2001.
48. Scheuermann BW, Bell C, Paterson DH, Barstow TJ, Kowalchuk JM. Oxygen uptake kinetics for moderate exercise are speeded in older humans by prior heavy exercise. *J Appl Physiol* 92: 609–616, 2002.
49. Seiyama A, Hazeki O, Tamura M. Noninvasive quantitative analysis of blood oxygenation in rat skeletal muscle. *J Biochem (Tokyo)* 103: 419–424, 1988.
50. Vercauysen F, Missenard O, Brisswalter J. Relationship between oxygen uptake slow component and surface EMG during heavy exercise in humans: Influence of pedal rate. *J Electromyogr Kinesiol* 2008 Apr 16 [Epub ahead of print].
51. Wells R, Morrissey M, Hughson R. Internal work and physiological responses during concentric and eccentric cycle ergometry. *Eur J Appl Physiol Occup Physiol* 55: 295–301.
52. Whipp BJ. The slow component of O₂ uptake kinetics during heavy exercise. *Med Sci Sports Exerc* 26: 1319–1326, 1994.
53. Whipp BJ, Davis JA, Torres F, Wasserman K. A test to determine parameters of aerobic function during exercise. *J Appl Physiol* 50: 217–221, 1981.
54. Whipp BJ, Rossiter H. The kinetics of oxygen uptake: physiological inferences from the parameters. In: *Oxygen Uptake Kinetics in Sport, Exercise and Medicine*, edited by Jones AM and Poole DC. London: Routledge, 2005, p. 62–94.
55. Willis WT, Jackman MR. Mitochondrial function during heavy exercise. *Med Sci Sports Exerc* 26: 1347–1353, 1994.
56. Wilkerson DP, Jones AM. Influence of initial metabolic rate on pulmonary O₂ uptake on-kinetics during severe intensity exercise. *Respir Physiol Neurobiol* 152: 204–219, 2006.
57. Wilkerson DP, Jones AM. Effects of baseline metabolic rate on pulmonary O₂ uptake on-kinetics during heavy-intensity exercise in humans. *Respir Physiol Neurobiol* 156: 203–211, 2007.
58. Wilkerson DP, Berger NJ, Jones AM. Influence of hyperoxia on pulmonary O₂ uptake kinetics following the onset of exercise in humans. *Respir Physiol Neurobiol*, 153: 92–106, 2006.
59. Wilkerson DP, Koppo K, Barstow TJ, Jones AM. Effect of prior multiple-sprint exercise on pulmonary O₂ uptake kinetics following the onset of perimaximal exercise. *J Appl Physiol* 97: 1227–1236, 2004.
60. Willis WT, Jackman MR. Mitochondrial function during heavy exercise. *Med Sci Sports Exerc* 26: 1347–1353, 1994.

Chapter 9: General Discussion

“And so, it is important to consider not simply what the well-fit τ reveals, but also what it might conceal.” (Whipp and Rossiter, 2005).

Kinetics is defined as “the science of the action of force in producing or changing motion,” (Chambers English Dictionary) and correct application of the term, therefore, is as a singular noun. Indeed, this appears consistent with its use to describe the dynamic adaptation of $\dot{V}O_2$ to an increase in contractile activity (e.g., $\dot{V}O_2$ on-kinetics at exercise onset) because pulmonary $\dot{V}O_2$ is considered to reflect *a response* that can be attributed predominantly to the muscle fibres contributing to the exercise challenge (Barstow *et al.*, 1990; Grassi *et al.*, 1996; Krstrup *et al.*, 2009). However, if this population comprises contractile units that respond differently (e.g., with different inertia and/or efficiency), this response heterogeneity would be masked within the homogenised pulmonary signal. Heretofore, our understanding of metabolic diversity in different muscle fibre types has been primarily gained from research with isolated rodent muscle preparations (Wendt and Gibbs, 1973; Crow and Kushmerick, 1982; Reggiani *et al.*, 1997; Behnke *et al.*, 2003; McDonough *et al.*, 2005). The purpose of this thesis was to investigate whether similar diversity exists in discrete segments of the motor unit recruitment pool *in vivo* in exercising humans.

Justification of the work-to-work model for assessing fibre-type diversity

Four of the five investigations that comprise the experimental chapters of this thesis involve use of the ‘work-to-work’ exercise model to isolate metabolic response diversity in different muscle fibre types. Prior to summarising the findings from these investigations, it is important to justify use of this model for this purpose. Work-to-

work exercise is differentiated by three distinct features that could independently or collectively be responsible for the slower phase II \dot{V}_{O_2} response that has been observed under these circumstances:

- 1.) an elevated baseline heart rate;
- 2.) an elevated baseline metabolic rate (\dot{V}_{O_2});
- 3.) an elevated baseline work rate.

Acceptance of the work-to-work model as a vehicle for unveiling response characteristics of discrete segments of the motor unit recruitment pool requires confirmation of #3 via refutation of #1 and #2.

Work-to-work effect: elevated baseline heart rate

As outlined in Chapter 2, Hughson and Morrissey (1982) suggested that sluggish O_2 delivery due to an elevated baseline HR and consequent shift from parasympathetic towards sympathetic HR control might be responsible for slower work-to-work \dot{V}_{O_2} kinetics. This suggestion is refuted by the following findings from Chapter 4, which support previous ones (e.g., Wilkerson and Jones, 2006; Wilkerson and Jones, 2007) that show a dissociation between HR kinetics and \dot{V}_{O_2} kinetics during high-intensity work-to-work cycle exercise:

- no lengthening of the HR τ_p for the work-to-work condition (37 ± 14 s and 36 ± 17 s for U→S and M→S Unprimed, respectively) despite an elevated baseline HR (unprimed, 79 ± 6 b·min⁻¹; primed, 98 ± 10 b·min⁻¹);
- a significantly longer \dot{V}_{O_2} τ_p for the work-to-work condition (33 ± 8 s and 42 ± 15 s for U→S and M→S Unprimed, respectively) despite no lengthening of the HR τ_p (see above).

More importantly, use of extreme pedal rates during moderate cycling in Chapter 7 allowed for an assessment of the degree to which the HR adaptation to exercise

influences the \dot{V}_{O_2} response during cycling that was exclusive to the moderate-intensity domain (i.e., the region assessed by Hughson and Morrissey (1982) where the effect of a shift from parasympathetic to sympathetic activation should be most profound). Specifically, even though moderate transitions were initiated from a baseline of 20-W cycling at both pedal rates, differences in both the cardioacceleratory stimulus derived from the degree of movement and the need to provide blood flow to support the oxidative cost of a greater amount of internal work (Francescato *et al.*, 1995) resulted in a baseline HR that was, on average, $26 \text{ b}\cdot\text{min}^{-1}$ higher during 20-W cycling at 115 compared to $35 \text{ rev}\cdot\text{min}^{-1}$. Furthermore, the lack of these components at $35 \text{ rev}\cdot\text{min}^{-1}$ resulted in a HR response that was essentially unchanged compared to resting HR during baseline cycling at this cadence. Collectively, this suggests that the parasympathetic mechanism for accelerating HR was available at 35, but not at $115 \text{ rev}\cdot\text{min}^{-1}$ (Yamamoto *et al.*, 1991), and this is confirmed by the HR τ_p values for the moderate transitions at the different pedal rates ($15 \pm 15 \text{ s}$ and $52 \pm 23 \text{ s}$ for $35 \text{ rev}\cdot\text{min}^{-1}$ and $115 \text{ rev}\cdot\text{min}^{-1}$, respectively; $P < 0.05$). Finally, these values are similar to those reported by MacPhee *et al.* (2005) for knee-extension exercise in the lower ($\sim 21 \text{ s}$) and upper ($\sim 42 \text{ s}$) moderate regions, which supports the contention that the parasympathetic-to-sympathetic shift that has been suggested to differentiate transitions in the upper compared to lower moderate region (Hughson and Morrissey, 1982) also differentiated transitions to the same relative moderate intensity (95% cadence-specific GET) at 115 compared to $35 \text{ rev}\cdot\text{min}^{-1}$ in the investigation performed in Chapter 7.

Despite a markedly slower HR adaptation during moderate transitions at 115 compared to $35 \text{ rev}\cdot\text{min}^{-1}$, there was no significant difference in the $\dot{V}_{O_2} \tau_p$ at extreme pedal rates ($26 \pm 7 \text{ s}$ and $29 \pm 8 \text{ s}$ for U \rightarrow M at 35 and $115 \text{ rev}\cdot\text{min}^{-1}$, respectively). It is also interesting to note that HR kinetics, which was significantly faster than \dot{V}_{O_2} kinetics at

35 rev·min⁻¹, became significantly slower than \dot{V}_{O_2} kinetics at 115 rev·min⁻¹ and, nevertheless, \dot{V}_{O_2} kinetics was unaltered. This latter observation has resonance with the findings of MacPhee *et al.* (2005), who observed slower HR and leg blood flow kinetics in the upper compared to lower moderate region that were still appreciably faster than \dot{V}_{O_2} kinetics. This would not be expected if HR/leg blood flow was rate-limiting the \dot{V}_{O_2} response.

In addition to a lack of association for changes in HR and \dot{V}_{O_2} kinetics for moderate-intensity transitions at 115 compared to 35 rev·min⁻¹ (e.g., $r = 0.22$; $P > 0.05$), there was also no agreement between changes in these two parameters for U→M v. U→H, U→H v. M→H or U→M v. M→H at either extreme pedal rate in Chapter 7. For example, while \dot{V}_{O_2} kinetics was significantly slower for M→H compared to U→M at both 35 and 115 rev·min⁻¹, HR kinetics was invariant across transitions at 115 rev·min⁻¹ and, although slower for M→H at 35 rev·min⁻¹, changes in the two parameters were uncorrelated.

Further insight regarding the degree to which characteristics of the work-to-work \dot{V}_{O_2} response can be attributed to limitations in HR/bulk O₂ delivery under these circumstances can be gained from the experiments performed in Chapters 4 and 5 where prior high-intensity exercise that increases tissue oxygenation (Burnley *et al.*, 2002a; Fukuba *et al.*, 2002; DeLorey *et al.*, 2004; DeLorey *et al.*, 2007; Jones *et al.*, 2008; Layak *et al.*, 2009) was used to prime the subsequent work-to-work response during upright cycle and prone knee-extension exercise. If work-to-work slowing under these circumstances (i.e., during exercise with the active musculature at/below heart level) was related to insufficient O₂ delivery, priming should have accelerated the sluggish response. Instead, there was no significant difference in the \dot{V}_{O_2} τ_p after priming

(Chapter 4: 42 ± 15 s and 42 ± 17 s for M→S Unprimed and M→S Primed, respectively; Chapter 5: 37 ± 5 s and 38 ± 9 s for M→H Unprimed and M→H Primed, respectively). Collectively, and in concert with previous research (e.g., Wilkerson and Jones, 2006; Wilkerson and Jones, 2007), these findings from Chapters 4, 5 and 7 provide strong evidence that slower \dot{V}_{O_2} kinetics during work-to-work transitions is not related to changes in the HR (and, by extension, bulk O₂ delivery) kinetics.

Work-to-work effect: elevated baseline metabolic rate (\dot{V}_{O_2})

By its very nature, a transition to a higher work rate from an elevated baseline work rate will also be characterised by a higher metabolic rate prior to the transition (e.g., baseline \dot{V}_{O_2} was ~64% higher for M→S Unprimed compared to U→S in Chapter 4). Therefore, instead of, or in addition to, differences that can be attributed to the specific population of muscle fibres that are isolated under these circumstances, \dot{V}_{O_2} kinetics could also be different during work-to-work transitions because of changes in the response characteristics of already-contracting fibres that would not be active (i.e., consuming O₂ at an increased rate) at baseline if a transition to the same work rate was initiated from rest/unloaded cycling. For example, considering models of respiratory control that have been advanced to explain regulation of mitochondrial function (Mahler, 1985; Meyer, 1988; Meyer, 1989), cellular O₂ consumption might increase slower in already-active fibres due to alterations in free ADP concentration and/or P_i via Michaelis-Menten enzyme kinetics (Chance and Williams, 1955). Furthermore, greater perturbation of the phosphorylation potential might be necessary to elicit a given increase in respiratory rate. Alternatively, or in addition, mitochondrial respiration might exhibit rate-dependent sensitivity to changes in Gibbs free energy of cytosolic ATP hydrolysis (ΔG_{ATP}) that results in an increased ATP requirement for a given change in contractile activity at higher power output (Jeneson *et al.*, 1995). A decreased ΔG_{ATP} is present

when phosphorylation potential is reduced. Finally, the role of calcium as a feed-forward mediator of respiratory control might be adversely affected in active fibres during work-to-work transitions due to changes in cytosolic $[Ca^{2+}]$ and/or ΔG_{ATP} (Hansford, 1994). Regardless of the mechanism, however, acceptance of the work-to-work model as a means for isolating response characteristics that are specific to discrete segments of the motor unit recruitment pool is only valid if an increased baseline metabolic rate (\dot{V}_{O_2}) independent of an increased baseline work rate does not elicit a similar work-to-work effect (i.e., does not lengthen $\dot{V}_{O_2} \tau_p$).

In most of the investigations that have analysed the influence of priming exercise on \dot{V}_{O_2} kinetics, baseline \dot{V}_{O_2} was elevated prior to the subsequent exercise bout; therefore, findings from these investigations can help to resolve whether an elevated \dot{V}_{O_2} alone elicits the characteristic work-to-work exercise effect. However, many of these studies separated priming and criterion bouts with somewhat lengthy periods of rest (e.g., six minutes) such that the \dot{V}_{O_2} elevation that was present at subsequent-bout onset was rather modest. Consequently, a direct comparison with the elevated baseline \dot{V}_{O_2} for the work-to-work conditions assessed within the experimental chapters of this thesis is dubious. However, Bailey *et al.* (2010) recently investigated six different combinations of prior exercise intensity and recovery duration, one of which required that subjects perform a transition to high-intensity cycling (80% Δ) after a prior bout of high-intensity cycling (70% Δ) plus three minutes of 20-W cycling. This resulted in a baseline \dot{V}_{O_2} that was, on average, $\sim 330 \text{ ml}\cdot\text{min}^{-1}$ greater prior to the subsequent bout and, nevertheless, as was the case with previous studies that assessed priming, τ_p was not lengthened by the intervention ($31 \pm 9 \text{ s}$ and $28 \pm 7 \text{ s}$ for control and elevated baseline \dot{V}_{O_2} , respectively (Bailey *et al.*, 2010). This demonstrates that phase II \dot{V}_{O_2} kinetics is not slowed consequent to an elevated baseline \dot{V}_{O_2} *per se*.

To further resolve whether an elevated baseline \dot{V}_{O_2} independent of an elevated baseline work rate could contribute to, or even be solely responsible for, the work-to-work exercise effect, pilot testing was done in conjunction with the experiments conducted for this thesis. Specifically, seven subjects performed a typical work-to-work exercise bout (high-intensity cycling at 60% Δ initiated from moderate-intensity cycling at 95% GET) and τ_p for this transition (M→H) was compared to τ_p for two consecutive bouts of high-intensity cycling initiated from a baseline work rate of 20 W. Importantly, the time separating these two bouts was specifically chosen for each subject such that the baseline \dot{V}_{O_2} from which the second transition was initiated was approximately equal to the baseline \dot{V}_{O_2} for the M→H transition (i.e., the moderate intensity steady state \dot{V}_{O_2}). Consequently, this double square-wave bout provided data for both a transition to high-intensity cycling from an unloaded baseline (first bout; U→H) and a transition to high-intensity cycling from an elevated \dot{V}_{O_2} with the same unloaded baseline (E→H).

Table 9.1 presents the parameters of import for each subject in the pilot testing detailed above and Figure 9.1 depicts the group mean \dot{V}_{O_2} response (normalised to the absolute \dot{V}_{O_2} amplitude upon completion of the fundamental response phase) for U→H, E→H and M→H cycling transitions. As is apparent, phase II \dot{V}_{O_2} kinetics was only slower when work rate was elevated prior to the high-intensity transition.

Work-to-work effect: elevated baseline work rate

Absence of evidence linking the work-to-work effect with HR and/or \dot{V}_{O_2} elevation implicates increased work rate at exercise onset as the feature that is responsible for unique aspects of these transitions. Consequently, use of this model in Chapters 4-7 is justified for providing insight into metabolic response characteristics specific to discrete segments of the motor unit recruitment pool. Furthermore, in Chapters 7 and 8,

Table 9.1: Baseline \dot{V}_{O_2} and τ_p values for seven subjects who performed cycling transitions to a high-intensity work rate (60% Δ) from either unloaded (U \rightarrow H and E \rightarrow H) or moderate-intensity (M \rightarrow H) baseline pedalling. E \rightarrow H was performed directly after U \rightarrow H and a period of 20-W cycling (mean \pm SD, 61 \pm 12 s; range, 45-75 s) that was specifically selected for each subject such that the baseline \dot{V}_{O_2} prior to the transition was similar to the baseline \dot{V}_{O_2} prior to M \rightarrow H. *Significant difference compared to the other two transitions ($P < 0.05$). See text for further details.

Sub	Mod (W)	High (W)	U \rightarrow H Transition		E \rightarrow H Transition		M \rightarrow H Transition	
			Base \dot{V}_{O_2} (L \cdot min $^{-1}$)	τ_p (s)	Base \dot{V}_{O_2} (L \cdot min $^{-1}$)	τ_p (s)	Base \dot{V}_{O_2} (L \cdot min $^{-1}$)	τ_p (s)
1	143	324	1.03	18	2.06	18	2.01	29
2	114	288	1.05	28	1.98	30	1.94	40
3	81	228	1.08	43	1.56	33	1.54	45
4	100	251	0.93	30	1.56	28	1.62	76
5	76	258	1.09	25	1.78	24	1.67	36
6	90	230	1.25	31	1.62	35	1.65	62
7	114	247	1.15	24	1.88	23	1.93	51
Mean	103	261	1.08*	28	1.78	27	1.77	48*
SD	23	34	0.10	8	0.21	6	.019	16

extremely slow and fast cycling cadences were investigated for the same purpose (Chapter 7, in conjunction with work-to-work exercise; Chapter 8, exclusively). It is generally accepted that the recruitment of higher-order fibres (i.e., fibres with faster twitch characteristics) is enhanced at greater contraction frequencies (Sargeant, 1999; MacIntosh *et al.*, 2000; Sargeant, 2007) and this has been cited as justification for use of cadence extremes to analyse the effect of manipulated fibre-type recruitment on \dot{V}_{O_2} kinetics (e.g., Barstow *et al.*, 1996; Pringle *et al.*, 2003b; see Table 2.2). However, considering that rate of energy turnover at a given power output (including 20-W baseline cycling) is greater at high compared to low contraction frequencies (Francescato *et al.*, 1995; Ferguson *et al.*, 2001), it is interesting to note that high-intensity cycling in these previous investigations was initiated from baseline work rates that were adjusted to compensate for this difference

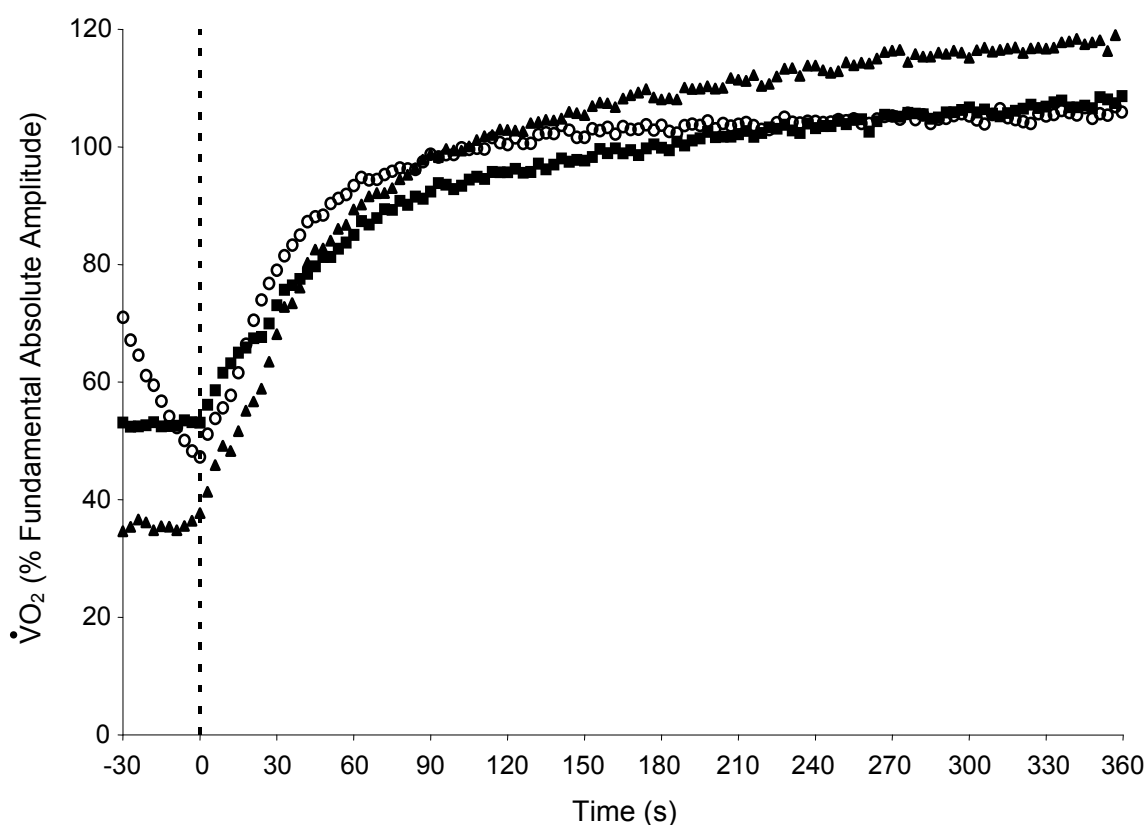

Figure 9.1: Group mean \dot{V}_{O_2} response where \dot{V}_{O_2} is expressed relative to the absolute \dot{V}_{O_2} amplitude upon completion of the fundamental response phase. Closed triangles represent the U→H condition, closed squares represent the M→H condition, and open circles represent the E→H condition. Vertical dashed line indicates the abrupt transition to the high-intensity work rate. Note that the phase II O_2 uptake kinetics is markedly slower for M→H transitions; however, this characteristic work-to-work effect is absent for E→H. This provides evidence that the effect occurs due to an elevated work rate, as opposed to an elevated metabolic rate (\dot{V}_{O_2}) *per se*.

(Barstow *et al.*, 1996; Pringle *et al.*, 2003b). This normalisation procedure would necessarily blunt the disparity between fibre recruitment patterns at slow and fast cadences because the increased work required at baseline for slower cadences would create work-to-work exercise conditions thereby isolating response characteristics of higher-, as opposed to lower-order fibres. For example, Barstow *et al.* (1996) reported that the work rate required to establish a similar baseline \dot{V}_{O_2} progressively increased at the slower pedal frequencies they assessed such that a work rate that was ~ 35 W greater was required at

their slowest cadence (45 rev·min⁻¹) to match baseline \dot{V}_{O_2} at their fastest (90 rev·min⁻¹). Owing to the greater disparity between cadences that were investigated within this thesis, the requisite work rate would have been substantially greater (e.g., 116 ± 28 W at 35 rev·min⁻¹ to match 20 W at 115 rev·min⁻¹).

In an attempt to maximise differences in muscle fibre-type recruitment at fast compared to slow cycling cadences in Chapters 7 and 8, baseline work rate was not adjusted at the slow cadence to normalise baseline \dot{V}_{O_2} . Consequently, in addition to differences in fibre recruitment that can be attributed to the same power output being sustained at a faster contraction frequency, manipulation of pedal frequency for these investigations also provides for work-to-work exercise conditions due to the increased amount of internal work being performed during 20-W cycling at the fast pedal cadence. All five experiments within this thesis are, therefore, based on the work-to-work exercise model, either solely (Chapters 4-6), in conjunction with manipulation of pedal rate (Chapters 7) or exclusively via manipulation of pedal rate (Chapter 8).

Work-to-work effect: at extreme pedal cadences

Collectively, findings from Chapters 4-7 provide evidence for the work-to-work model in conjunction with manipulation of pedal rate as a powerful means for assessing the influence of muscle fibre recruitment on \dot{V}_{O_2} kinetics. Specifically, Table 9.2 presents results that show how the lengthening of \dot{V}_{O_2} τ_p that is present for M→H compared to U→M transitions at slow (Chapters 5 and 7) and mid-range (Chapter 6) contraction frequencies is exacerbated at extremely fast cycling cadences (Chapter 7). This occurs despite a similar primary phase $\Delta[\text{HHb}]/\Delta\dot{V}_{O_2}$ (an index of fractional O₂ extraction; DeLorey *et al.*, 2007) during high-intensity cycling at extreme cadences (i.e., at 35 and 115

Table 9.2: Phase II τ values for unloaded-to-moderate and moderate-to-high-intensity cycling and knee-extension exercise transitions at different contraction frequencies. Combined data from Chapters 5, 6 and 7. *Significant difference compared to U→M condition ($P < 0.05$).

Mode of Exercise	Contraction frequency (contractions·min ⁻¹)	U→M	M→H
Upright Cycling	35	26 ± 7	36 ± 8 *
Knee-extension	40	26 ± 8	37 ± 5
Upright Cycling	80	26 ± 7	38 ± 10 *
Upright Cycling	115	29 ± 8	53 ± 20 *

rev·min⁻¹; Chapter 8) which, in conjunction with previous findings (e.g., Ferguson *et al.*, 2001; Ferreira *et al.*, 2006a), implies that bulk O₂ delivery is not restricted at rapid contraction frequencies. It can, therefore, be concluded that recruitment of a different fractional portion of the motor unit recruitment pool is responsible for both work-to-work slowing and cadence-related amplification of this effect.

Key findings from experimental chapters*Muscle fibre type and O₂ availability*

To elucidate why τ_p is longer in high- compared to low-order fibres (i.e., in M→H compared to U→M transitions), subjects performed work-to-work exercise after prior high-intensity priming exercise (Chapters 4, 5 and 6) and in the supine body position (Chapter 6). Priming a subsequent exercise bout is useful for determining whether \dot{V}_{O_2} kinetics is rate-limited by O₂ availability because high-intensity prior exercise increases muscle blood flow and indices of tissue oxygenation before and during a subsequent exercise bout (Burnley *et al.*, 2002a; Fukuba *et al.*, 2002; DeLorey *et al.*, 2004; DeLorey *et al.*, 2007; Jones *et al.*, 2008; Layak *et al.*, 2009). Conversely, during supine exercise and any other contractile activity with the active musculature at or above heart level, the gravitational assist to muscle blood flow is absent, perfusion pressure is reduced and the adaptation of O₂ delivery is slowed (MacDonald *et al.*, 1998). Therefore, if the lengthened τ_p that high-order fibres demonstrate under normal exercise conditions (i.e., with the exercising musculature below heart level) reflects O₂-dependent regulation in these fibres (e.g., see Chapter 2), the supine posture should exacerbate this lengthening and priming should shorten τ_p for both upright and supine work-to-work transitions.

As was expected, τ_p was longer for M→H compared to U→M transitions (see Table 9.2). Furthermore, the supine posture lengthened τ_p during M→H cycling by an additional ~50% (Chapter 6). However, while priming did shorten τ_p to the upright control condition value for M→H supine cycling, it did not affect the parameter in either instance when only ‘normal’ work-to-work slowing was present (42 ± 15 v. 42 ± 17 s and 37 ± 5 v. 38 ± 9 s for unprimed and primed upright cycling and knee-extension exercise, respectively; Chapters 4 and 5). Interestingly, τ_p for [PCr], which was not significantly different from τ_p for \dot{V}_{O_2} in

either the unprimed or primed states, was also unaltered by priming (37 ± 11 v. 34 ± 12 s for unprimed and primed knee-extension exercise, respectively; Chapter 5). Collectively, these findings support the role of [PCr] as a critical rate modulator of \dot{V}_{O_2} kinetics (Mahler, 1985; Meyer, 1988; Meyer, 1989) and confirm that type II fibres are sensitive to decreased O_2 availability. However, they do not support the notion that insufficient bulk O_2 delivery under normal circumstances is responsible for the sluggish \dot{V}_{O_2} kinetics in higher-order fibres.

Figure 9.2 presents an attempt to reconcile these observations from human muscle *in vivo* with those gleaned from rat/mouse muscle *in vitro* (see Chapter 2). The depicted schematic is a modified version of the model proposed by Poole and Jones where O_2 delivery only affects \dot{V}_{O_2} kinetics when a critical tipping point that separates O_2 -delivery independent and dependent zones is crossed (Poole and Jones, 2005; Poole *et al.*, 2007; Poole *et al.*, 2008). However, in this case, instead of a single whole-muscle continuum (e.g., see Figure 2.6), separate ones are depicted for type I and type II fibres. (Note: More gradual gradations in metabolic function from one end of the fibre-recruitment hierarchy to the other might very well render this two-tiered depiction a gross oversimplification.)

The fibre-type specific tipping point

In Figure 9.2, X_n represents the point on each fibre-type-specific continuum where fibres operate under normal circumstances. As is apparent, X_n for type II fibres is situated further to the left on the x -axis, which reflects the fact that these fibres receive less blood flow to support any given \dot{V}_{O_2} including that required at rest (Behnke *et al.*, 2006). The consequence of this characteristic is that type II fibres must rely more on fractional O_2 extraction at rest and during both low- and high-intensity contractile activity (Behnke *et al.*,

2003; McDonough *et al.*, 2005; Behnke *et al.*, 2006) and failure to do so to a sufficient extent will result in O_2 dependency and resultant slowing of $\dot{V}O_2$ kinetics. Therefore, the fibre-type-specific proximity of X_n to the tipping point (dashed vertical line) is a critical metabolic characteristic because the divide represents a ‘buffer zone’ reflective of the capacity of the fibre to increase O_2 extraction and preserve τ_p when tissue oxygenation is reduced. Findings from *in-vivo* human muscle during exercise that support the positioning of X_n with respect to the tipping point can be found in the data presented in Chapter 6,

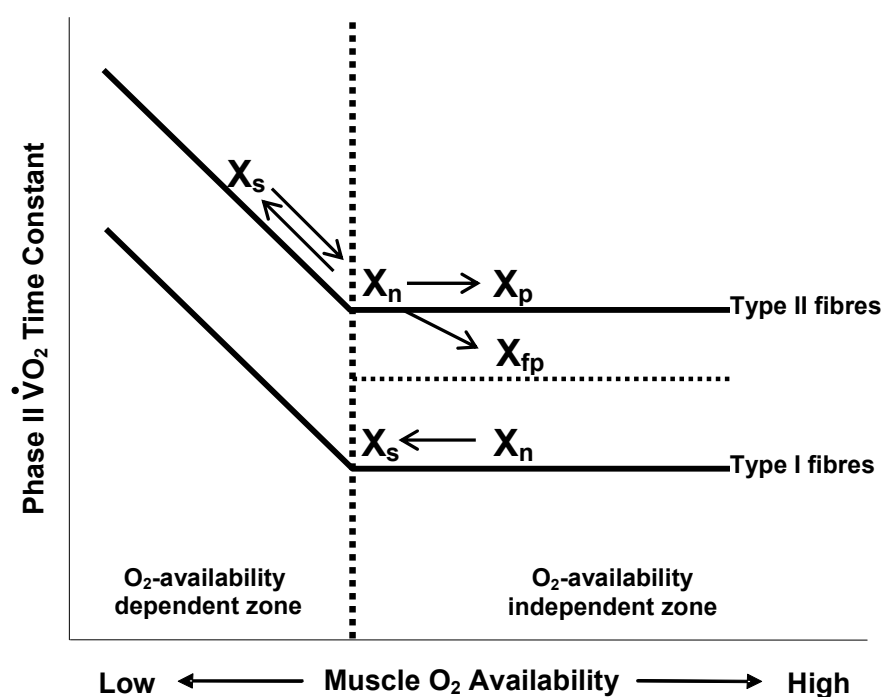

Figure 9.2: Illustration of a modified version of the tipping point theory that demarcates a fibre-type-specific degree of influence that O_2 availability plays in setting the phase II $\dot{V}O_2$ time course. In the original model advanced by Jones and Poole (2005), no distinction was made for muscle fibre type. X_n , ‘normal’ position; X_s , position for supine exercise (blood flow restriction); X_p , position for primed exercise (blood flow enhancement); X_{fp} position for ‘fast’ primed exercise. Note: Within this portrayal, “muscle O_2 availability” represents bulk blood flow/ O_2 delivery to the region. Distribution of that flow is responsible for the relative position of X_n on the x -axis. See text for further explanation.

which were acquired when subjects performed U→M and M→H cycling transitions in both the upright and supine body positions. A key result from this study was that τ_p was unchanged in the supine compared to upright position for U→M and this preservation of \dot{V}_{O_2} kinetics in the face of reduced oxygenation occurred in conjunction with a significantly greater $\Delta[\text{HHb}]/\Delta\dot{V}_{O_2}$ (i.e., fractional O_2 extraction; DeLorey *et al.*, 2007). Conversely, the significant lengthening of τ_p that occurred for the supine compared to upright M→H transition (see above) was accompanied by an unchanged $\Delta[\text{HHb}]/\Delta\dot{V}_{O_2}$ and faster [HHb] kinetics (a reduced [HHb] slow component and shortened [HHb] MRT). In light of these observations, X_s has been positioned in Figure 9.2 to represent the point on each fibre-type-specific continuum where fibres operated in the supine position and $X_s \leftarrow X_n$, therefore, indicates the fibre-type-specific effect of that degree of reduced oxygenation on \dot{V}_{O_2} kinetics.

The precipitous fall and transient overshoot of $PmvO_2$ at the onset of contractile activity in type II fibres (McDonough *et al.*, 2005) could be interpreted as evidence that these fibres likely demonstrate a lengthened τ_p (Crow and Kushmerick, 1982) because their \dot{V}_{O_2} kinetics is O_2 dependent (Behnke *et al.*, 2002a; see Chapter 2). However, as stated above, priming (i.e., increased tissue oxygenation) only reduced the M→H τ_p when τ_p was further lengthened by the supine posture. Conversely, for upright M→H, τ_p was unchanged after priming (Chapter 4). In light of these observations, $X_s \rightarrow X_n$ (diagonally downward shift to the right) and $X_n \rightarrow X_p$ (horizontal shift to the right) represent the effect of increased tissue oxygenation on type II fibres operating in the O_2 -delivery dependent and independent zones, respectively.

Given the different $P_{mv}O_2$ profiles observed for type I and type II fibres (Behnke *et al.*, 2003; McDonough *et al.*, 2005), it is interesting to consider why X_n is not positioned to the left of the tipping point on the type II fibre continuum for healthy human muscle *in vivo*. One possible explanation is that by selecting type I and type II rat muscle with similar citrate synthase activity to control for oxidative capacity (i.e., remove the confounding variable of a faster rate of O_2 utilisation in type I fibres), the conclusions drawn by Behnke *et al.* (2003) might only be applied with caution to ‘typical’ human muscle *in vivo*. For example, an innate sluggishness in the ability to *use* the O_2 that is available for consumption for type II fibres *in vivo* might render sufficient their limited capacity to increase fractional O_2 extraction, thereby allowing them to still operate at or to the right of the tipping point during metabolic transitions. Consequently, (albeit innately slower) \dot{V}_{O_2} kinetics will be preserved. This explanation is consistent with the findings of Ferreira *et al.* (2006b), who measured muscle blood flow alongside $P_{mv}O_2$ and reported what would be expected given previous findings – an upward shift of the hyperbolic a- vO_2 diff-to- \dot{V}_{O_2} relationship (i.e., greater fractional O_2 extraction to support a given \dot{V}_{O_2}) and a lower y-intercept (i.e., blood flow at rest) in type II fibres. However, these researchers also found that the slope of the blood flow-to- \dot{V}_{O_2} relationship was similar in muscles of different fibre types and oxidative capacities. This apparent matching of O_2 delivery to utilisation (albeit from a lower starting point) as contractile intensity is increased is consistent with the notion that reduced blood flow that mandates increased O_2 extraction might only place type II fibres precariously close to (as opposed to entrenched within) the O_2 -delivery dependent zone (Figure 9.2). Furthermore, this would explain a rightward horizontal (as opposed to diagonal downward) $X_n \rightarrow X_p$ (i.e., why priming does not reduce the upright M \rightarrow H τ_p ; chapters 4 and 5).

Muscle fibre type and metabolic inertia

In addition to the relevance of fibre-type-specific placement of x_n on the x -axis in Figure 9.2, it is also interesting to consider its relative positioning on the y -axis. Specifically, despite the fact that type II fibres operate in the O_2 -independent zone when uncompromised tissue oxygenation is present (see above), τ_p is still longer compared to type I fibres (Crow and Kushmerick, 1982; Pringle *et al.*, 2003a). Slower \dot{V}_{O_2} kinetics under these circumstances suggests a restricted ability to use the O_2 that is available and this is supported by findings of Kindig *et al.* (2003), who assessed the regulatory effect of O_2 concentration on oxidative phosphorylation by manipulating extracellular PO_2 in isolated single myocytes of *Xenopus laevis*, a frog muscle that lacks myoglobin. Using phosphorescence quenching techniques to determine the fall in intracellular PO_2 (which, in the absence of myoglobin, is proportional to the rise in \dot{V}_{O_2}) from rest across a bout of high-intensity contractions, these researchers showed that to achieve peak metabolic rates in this glycolytic muscle, O_2 was required at levels significantly higher than what would be expected physiologically *in vivo*. However, the initial rate of change in intracellular PO_2 (i.e., initial rise in \dot{V}_{O_2}) was not increased at higher extracellular PO_2 values (i.e., when a higher driving gradient for O_2 flux was present; e.g., a very high critical PO_2 of ~ 54 Torr was estimated). The authors concluded that myocytes with low oxidative capacity may not be limited by O_2 even when extracellular PO_2 is very low because O_2 does not play an integral role in setting the initial metabolic response in these myocytes (Kindig *et al.*, 2003).

A reduced capacity for type II fibres to use available O_2 could reflect greater oxidative enzymatic inertia (Staron, 1997) and/or slower [PCr] dynamics (Söderlund and Hultman, 1991; Kindig *et al.*, 2005; Jones *et al.*, 2008). Regardless of the mechanistic basis,

however, this fibre-type-specific characteristic is important because a slower \dot{V}_{O_2} response engenders a greater O_2 deficit that must be endured during the initial stage of exercise (see Figure 1.1). It is, therefore, interesting to consider interventions that could help to rectify this innate sluggishness. For example, in Chapter 8, τ_p for U→H cycling at both extreme pedal rates was decreased following a fast-cadence priming bout (i.e., during 115→35 and 115→115) and this change (depicted in Figure 9.2; see $X_n \rightarrow X_{fp}$) was accompanied by NIRS-derived evidence that $[O_2Hb]$ and total $[Hb]$ were significantly greater in the area of interrogation (vastus lateralis) after priming. However, a slower rate of $[HHb]$ adaptation (e.g., increased $[HHb]$ TD and/or τ and/or MRT), which would be expected if a limitation in bulk O_2 supply had been circumvented (e.g., see DeLorey *et al.*, 2004), was not present for either transition. Furthermore, $[O_2Hb]$ and total $[Hb]$ were also increased during 35→115 (i.e., when slow-cadence cycling not specific to higher-order fibres was used to prime the subsequent fast-cadence response), but under these circumstances, \dot{V}_{O_2} kinetics was unchanged. Collectively, these observations cohere with the notion that the lengthened τ_p in higher-order fibres (e.g., 48 ± 16 s v. 31 ± 7 s in the unprimed control condition for 115 and 35 $\text{rev}\cdot\text{min}^{-1}$ cycling, respectively; Chapter 8) is not the result of these fibres operating in the O_2 -dependent zone under normal conditions (see above and Figure 9.2).

While bulk O_2 delivery did not discriminate the presence or absence of accelerated \dot{V}_{O_2} kinetics in Chapter 8, O_2 extraction did. Specifically, $\Delta[HHb]/\Delta\dot{V}_{O_2}$ was increased during the fundamental \dot{V}_{O_2} response phase during both 115→35 and 115→115 (i.e., when τ_p was shortened by priming), but not during 35→115 (i.e., when no priming-induced change of τ_p took place). This is consistent with a priming-induced O_2 -independent τ_p shift (i.e., $X_n \rightarrow X_{fp}$ lies completely to the right of the tipping point in Figure 9.2). It is also interesting to note that despite a presumed similarity in O_2 availability at cadence extremes in the

unprimed control condition (e.g., see Ferguson *et al.*, 2001; Ferreira *et al.*, 2006a), τ_p was longer for fast-cadence cycling (see above) and there was no significant difference in fundamental $\Delta[\text{HHb}]/\Delta\dot{V}_{\text{O}_2}$ between cadences. Collectively, these findings support the contention that there is innate sluggishness in the ability for type II fibres to use O_2 that is available for consumption and the only way to rectify this is to improve their ability to extract that O_2 from the blood (e.g., by fast-cadence priming; Chapter 8).

Fibre-type specific metabolic inertia: directions for future research

Before leaving this topic, it is interesting to consider other interventions that might be fibre-type-specific with respect to facilitating a downward shift of x_n on the y -axis in Figure 9.2 (i.e., reducing the metabolic inertia that rate limits \dot{V}_{O_2} kinetics under normal conditions in both principal fibre types). For example, if Meyer's analogue model of respiratory control (see Figure 2.7) is accurate, the creatine kinase reaction acts as a capacitor for oxidative phosphorylation and is, therefore, an important mediator of metabolic inertia. Accordingly, it is not surprising that increasing muscle total creatine content (which provides the stored charge on the capacitor) via creatine loading results in slower muscle [PCr] (and, presumably, \dot{V}_{O_2} ; see Chapter 2, but also see Jones *et al.*, 2002) kinetics across transitions from rest to both moderate- and high-intensity knee-extension exercise (Jones *et al.*, 2009). Conversely, at the onset of isometric tetanic contractions in *Xenopus* isolated single myocytes, acute creatine kinase inhibition results in a more rapid fall in intracellular PO_2 (indicative of accelerated oxidative phosphorylation and, therefore, analogous to a shortened \dot{V}_{O_2} τ_p in this model) (Kindig *et al.*, 2005). However, although elegant in both cases, these findings do not discern the degree to which these effects were fibre-type specific. Use of the work-to-work model in the former case (*in-vivo* creatine loading) and

analysis of muscles of disparate fibre-type in the latter (*in-vitro* creatine kinase inhibition) could provide this insight.

Similar to creatine kinase inhibition, it has been shown that inhibition of nitric oxide (NO) synthesis results in faster phase II \dot{V}_{O_2} kinetics in humans at the onset of both moderate (Jones *et al.*, 2003) and high-intensity (Jones *et al.*, 2004b), and also supramaximal (Wilkerson *et al.*, 2004a), cycling. This acceleratory effect is presumed to occur due to removal of NO inhibition of key tricarboxylic acid/electron transport chain enzymes and/or its competition for O₂ binding at cytochrome *c* oxidase (Shen *et al.*, 1994). Regardless of the mechanism, however, removal of any NO-related metabolic inertia would allow increased O₂ extraction to support a more rapid \dot{V}_{O_2} increase at exercise onset.

With respect to fibre-type specific effects of NO, it is interesting to note that the tendency for τ_p to grow longer as exercise intensity was increased across the three studies mentioned above (e.g., ~22 s, ~25 s and ~36 s for moderate, heavy and supramaximal transitions, respectively) was abolished when NO production was inhibited (Jones *et al.*, 2003; Jones *et al.*, 2004b; Wilkerson *et al.*, 2004a). Furthermore, the speeding of \dot{V}_{O_2} kinetics following NO synthesis inhibition during supramaximal cycling was significantly correlated with the absolute value of τ_p in the control condition (Wilkerson *et al.*, 2004a). Collectively, these observations are consistent with greater NO-mediated metabolic inertia in higher-order fibres. However, all transitions in these studies were initiated from a baseline of 20-W cycling and, therefore, although a wide range of intensities were spanned, results for below GET and above GET transitions reflect response profiles for only an homogenous pool of low-order fibres and an heterogeneous pool of mixed fibres, respectively. Furthermore, during heavy exercise, the \dot{V}_{O_2} slow component was *increased* by this intervention (Jones *et*

et al., 2004b), which is not consistent with faster kinetics and further suggests that higher-order fibres (often assumed to be associated with this phenomenon; e.g., see Barstow *et al.*, 1996; Pringle *et al.*, 2002a; Pringle *et al.*, 2002b) might experience a different effect. NO has myriad physiological functions including vasodilation in contracting muscles at exercise onset (Moncada *et al.*, 1991); therefore, its inhibition has the potential to cause a transient reduction or greater heterogeneity of blood flow in active muscle during exercise (Dyke *et al.*, 1995; Radegran and Saltin, 1999). This decreased oxygenation could increase the amplitude of the \dot{V}_{O_2} slow component (Koga *et al.*, 1999) either directly and/or indirectly via changes in motor unit activation patterns (Moritani *et al.*, 1992). If this was the case, the *shortened* τ_p that was observed despite this restriction provides further evidence that the fibres defining the primary response under these circumstances (i.e., predominantly type I fibres) benefit from a 'buffer zone' that protects against τ_p lengthening (see Figure 9.2). At any rate, an increased \dot{V}_{O_2} slow component and possible fibre-type-specific differences of the effect on τ_p suggest that work-to-work exercise could be a useful model to employ in conjunction with NO inhibition.

Motor unit activation and the \dot{V}_{O_2} slow component

It is attractive to speculate upon an association between delayed-onset motor unit activation and the \dot{V}_{O_2} slow component (Whipp, 1994; Gaesser and Poole, 1996; Jones *et al.*, 2005). However, to date, a review of the literature reveals equivocal findings with respect to a definitive link between time-dependent increases in neuromuscular activity during supra-GET exercise and the continued rise in \dot{V}_{O_2} (see Tables 2.3 and 2.4). Four of the five investigations that comprise the experimental chapters of this thesis include the use of electromyography to quantify gross electrical activity of active muscle during exercise and from these measurements, changes in motor unit activation (i.e., recruitment and rate

coding) as exercise proceeds can be inferred. In addition, three of these investigations also detail electromyographic changes after high-intensity priming, which can alter the amplitude of the \dot{V}_{O_2} slow component under some circumstances. Findings from these four chapters, therefore, provide considerable insight that helps to resolve previous ambiguity regarding: 1) the presence of a delayed-onset iEMG change accompanying the \dot{V}_{O_2} slow component during high-intensity exercise (e.g., Scheuermann *et al.*, 2001; Sabapathy *et al.*, 2005; Bailey *et al.*, 2010); and 2) the association between priming-induced slow component alterations and changes in motor unit activation patterns (e.g., Scheuermann *et al.*, 2001; Burnley *et al.*, 2002a; Bailey *et al.*, 2010).

Does iEMG change with time during high-intensity exercise?

If the \dot{V}_{O_2} slow component reflects changes in motor unit activation as high-intensity exercise proceeds (e.g., Chapter 2; Theories 1, 2 and 3 on pp. 84-85), a significant difference should exist between iEMG at the end of supra-GET exercise and values measured during early stages (i.e., Δ iEMG should be positive). Conversely, during moderate exercise, iEMG should remain relatively stable throughout. The following findings from the experimental chapters of this thesis support these contentions:

- For vastus lateralis during unprimed and primed R→M knee-extension exercise at ~15% MVC (no \dot{V}_{O_2} slow component present), mean iEMG during minute six was not significantly different from mean iEMG during minute one (Chapter 5; Figure 4).
- For vastus lateralis during unprimed and primed U→M supine cycling at ~95% GET (no \dot{V}_{O_2} slow component present), mean iEMG at minute six was not significantly different from mean iEMG at minute two (Chapter 6; Figure 6).

- For vastus lateralis and gluteus maximus during slow- and fast-cadence U→M cycling at 95% GET (no \dot{V}_{O_2} slow component present in either case), summed mean iEMG at minute six was not significantly different from summed mean iEMG at minute two (Chapter 7; Figure 3).
- For vastus lateralis during U→H and unprimed M→H cycling at 70% Δ (\dot{V}_{O_2} slow component equivalent to ~23% of the overall \dot{V}_{O_2} response in both cases), mean iEMG at minute six was significantly greater than mean iEMG at minute two (Chapter 4; Figure 5). (Note: the terms “U→S” and “M→S” that are used in Chapter 4 are synonymous with the terms “U→H” and “M→H,” which are used throughout the rest of this thesis and in these passages.)
- For vastus lateralis during unprimed M→H knee-extension exercise at ~35% MVC (\dot{V}_{O_2} slow component equivalent to ~41% of the overall \dot{V}_{O_2} response), mean iEMG during minute six was significantly greater than mean iEMG during minute one (Chapter 5; Figure 4).
- For vastus lateralis during unprimed and primed M→H supine cycling at 70% Δ (\dot{V}_{O_2} slow component equivalent to ~17% and ~21% of the overall \dot{V}_{O_2} response, respectively), mean iEMG at minute six was significantly greater than mean iEMG at minute two (Chapter 6; Figure 6).
- For vastus lateralis and gluteus maximus during fast-cadence U→H and M→H cycling at 60% Δ (\dot{V}_{O_2} slow component equivalent to ~17% and ~14% of the overall \dot{V}_{O_2} response, respectively), summed mean iEMG at minute six was significantly greater than summed mean iEMG at minute two (Chapter 7; Figure 3).

Furthermore, the $\Delta\dot{V}_{O_2}/\Delta iEMG$ ratio remained stable after minute two throughout both unprimed and primed R→M knee-extension exercise (no \dot{V}_{O_2} slow component present in either case) and also throughout unprimed and primed M→H knee-extension exercise (\dot{V}_{O_2} slow component present in both cases) (Chapter 5; Figure 5). Collectively, these findings from Chapters 4-7 provide strong support for the notion that changes (or lack thereof) in motor unit activation as exercise proceeds is a major determinant of a slow component increase (or lack thereof) in the pulmonary \dot{V}_{O_2} response. However, the following findings from the experimental chapters of this thesis do not support this contention. (Note: See “ \dot{V}_{O_2} slow component: delayed-onset fibre activation” below for potential reconciliation of these differences):

- For vastus lateralis during primed M→H cycling at 70% Δ (\dot{V}_{O_2} slow component equivalent to ~15% of the overall \dot{V}_{O_2} response), mean iEMG at minute six was not significantly different from mean iEMG at minute two (Chapter 4; Figure 5).
- For vastus lateralis during primed M→H knee-extension exercise at ~35% MVC (\dot{V}_{O_2} slow component equivalent to ~22% of the overall \dot{V}_{O_2} response), mean iEMG during minute six was not significantly different from mean iEMG during minute one (Chapter 5; Figure 4).
- For vastus lateralis and gluteus maximus during slow-cadence U→H and M→H cycling at 60% Δ (\dot{V}_{O_2} slow component equivalent to ~12% and ~14% of the overall \dot{V}_{O_2} response, respectively), summed mean iEMG at minute six was not significantly different from summed mean iEMG at minute two (Chapter 7; Figure 3).

Are priming-induced changes in \dot{V}_{O_2} kinetics reflected in altered iEMG?

If the \dot{V}_{O_2} slow component reflects changes in motor unit activation (see above), a priming-induced decrease of slow component amplitude (i.e., the characteristic prior-exercise effect) should be accompanied by a decreased Δ iEMG. Conversely, in circumstances where the prior-exercise effect is not present, Δ iEMG should be unaltered by priming. The following findings from the experimental chapters of this thesis support these contentions:

- For vastus lateralis during primed M→H cycling at 70% Δ (priming-induced \dot{V}_{O_2} slow component reduction of ~43%), Δ iEMG₍₆₋₂₎ was significantly lower compared to unprimed M→H cycling at 70% Δ (Chapter 4; Figure 5).
- For vastus lateralis during primed M→H knee-extension exercise at ~35% MVC (priming-induced \dot{V}_{O_2} slow component reduction of ~46%), the significant difference in mean iEMG for minute six compared to minute one that was present during unprimed M→H knee-extension exercise at ~35% MVC was ablated (Chapter 5; Figure 4).
- For vastus lateralis during primed M→H supine cycling at 70% Δ (\dot{V}_{O_2} slow component unchanged compared to the unprimed control condition), Δ iEMG₍₆₋₂₎ was not significantly affected by priming (Chapter 6; Figure 6).

Furthermore, despite a marked difference in the \dot{V}_{O_2} response to M→H knee-extension exercise after priming, the $\Delta\dot{V}_{O_2}/\Delta$ iEMG ratio after minute two was not significantly different for the unprimed and primed conditions (Chapter 5; see Figures 1 and 5, respectively). Collectively, these findings from Chapters 4-6 are consistent with the notions that: 1) the \dot{V}_{O_2} slow component reflects changes in motor unit activation during high-intensity exercise; and 2) changes in delayed-onset motor unit activation after priming play an important role in the altered \dot{V}_{O_2} profile that is observed. However, there was no

significant correlation between the reduction in the amplitude of the \dot{V}_{O_2} slow component and the reduction in $\Delta iEMG_{(6-2)}$ after priming during upright M→H in Chapter 4, which implies further complexity.

\dot{V}_{O_2} slow component: delayed-onset fibre activation

The majority of the findings presented above suggest that a time-dependent increase in neuromuscular activation does differentiate exercise above compared to below GET (i.e., exercise characterised by the presence or absence of a \dot{V}_{O_2} slow component, respectively). For example, of the 11 high-intensity exercise conditions for which electromyographic data was collected in the experimental chapters of this thesis, seven were characterised by a significant increase of iEMG with time. Conversely, none of the six moderate transitions that were assessed displayed a similar change. Furthermore, it is interesting to note that two of the four high-intensity conditions for which iEMG did not change with time (M→H Primed cycling and M→H Primed knee-extension exercise in Chapters 4 and 5, respectively) involved bouts that were performed after high-intensity priming. It has been suggested that priming lowers motor unit recruitment thresholds during subsequent exercise such that more high-threshold fibres are activated at or close to exercise onset (Burnley *et al.*, 2002a; Burnley *et al.*, 2005; Bailey *et al.*, 2010). More fibres contributing to power production early in a primed bout would explain the increased absolute amplitude for the fundamental \dot{V}_{O_2} response that is typically observed after priming (Burnley *et al.*, 2001; e.g., see Chapter 4, Table 2) and also the decreased \dot{V}_{O_2} slow component if less high-threshold motor units were subsequently recruited as exercise proceeded (Burnley *et al.*, 2005). Consequently, a priming-induced change similar to that which has been suggested (Burnley *et al.*, 2002a; Burnley *et al.*, 2005; Bailey *et al.*, 2010) (which would be consistent with the reduced $\Delta iEMG$ that was present for the primed compared to unprimed condition

for each of these transitions; see above) could explain why iEMG did not change with time during each of these primed bouts. However, while the \dot{V}_{O_2} slow component was markedly reduced for each of these transitions, it was *not* totally eliminated; therefore, attributing its existence exclusively to delayed-onset motor unit activation under normal (i.e., unprimed) circumstances might be inappropriate.

With respect to high-intensity conditions within the experimental chapters of this thesis that were not characterised by a significant increase of iEMG with time, in addition to cycling and knee-extension M→H after priming, iEMG also remained stable during both U→H and M→H cycling at 35 rev·min⁻¹ (i.e., an extremely slow pedal rate) (Chapter 7; see Figure 3). Interestingly, the slow component only represented ~12% and ~14% of the total \dot{V}_{O_2} response under these circumstances, which is less than what is typically present during unprimed upright cycling at 80 rev·min⁻¹ (e.g., ~23% and ~19% for U→H and ~23% and ~22% for M→H; Chapters 4 and 6), but similar to what was observed during upright M→H cycling at 80 rev·min⁻¹ after priming (~15%; Chapter 4). Given that a priming-induced elimination of Δ iEMG was associated with a slow component reduction of ~43% for that transition, these observations could be interpreted as evidence that under normal exercise conditions (i.e., unprimed cycling at mid-range pedal rates), approximately half of the \dot{V}_{O_2} slow component can be attributed to delayed-onset fibre activation. Conversely, after priming and at extremely slow pedal cadences (i.e., at contraction frequencies that are better suited to lower-order fibres), the \dot{V}_{O_2} rise during what is considered the slow component phase would be mediated by factors other than delayed-onset fibre activation – factors that typically comprise the other ~50% of the slow component response under normal conditions.

\dot{V}_{O_2} slow component: reduced efficiency in initially-active fibres

In addition to explaining how a slow component can be present without delayed-onset iEMG changes (e.g., Scheuermann *et al.*, 2001; Garland *et al.*, 2006; Chapters 4, 5 and 7), a slow component that can potentially comprise multiple contributing factors also helps to explain how \dot{V}_{O_2} can stay constant in the presence of falling power output (equivalent to a rise in \dot{V}_{O_2} during constant-load exercise) in maximally-activated dog muscle *in situ* (Zoladz *et al.*, 2008). (Note: This effect is also evident when humans perform all-out exercise and \dot{V}_{O_2} remains at its maximum while power output falls; e.g., see Vanhatalo *et al.*, 2007). Theoretically, such a temporal reduction in muscle efficiency in a model where no additional fibre recruitment can occur must be related to energetic changes in initially-recruited fibres; i.e., either a progressive increase in the ATP required for a given tension production and/or a progressive decrease in the high-energy phosphate produced per given unit O_2 consumed (Zoladz *et al.*, 2008). However, during knee-extension exercise in humans, the slow component increase in \dot{V}_{O_2} is mirrored by a slow component decrease in intramuscular [PCr] (Rossiter *et al.*, 2002a; Rossiter *et al.*, 2002b; Chapter 5), which is only consistent with the former. An increase in the ATP cost of tension development could occur due to a fatigue-induced reduction in ΔG_{ATP} either independently or in association with changes in sarcoplasmic reticulum Ca^{2+} pump efficiency (Zoladz *et al.*, 2008). Regardless of the mechanistic basis, however, it is likely that if initially-recruited fibres did experience this loss of contractile efficiency, the effect would be greater in fatigue-sensitive higher-order fibres (Jones *et al.*, 2005; Sargeant and de Haan, 2006).

The \dot{V}_{O_2} slow component: response heterogeneity in initially-active fibres

The two mechanisms suggested above to explain the sustained \dot{V}_{O_2} rise during high-intensity exercise both with and without a delayed-onset iEMG increase are markedly

different; however, each is based upon the notion that fatigue-related changes precipitate the rise. However, in addition to a time-dependent loss of contractile efficiency, it is also possible that the portion of the slow component that is not attributable to delayed-onset fibre activation (i.e., ~50% under normal circumstances; see above) might at least partially reflect response heterogeneity in initially-active fibres. It is generally assumed that the slow component is of delayed-onset (Barstow and Mole, 1991; Paterson and Whipp, 1991); however, this is far from certain. For example, Whipp *et al.* (2005) suggest that although the slow component appears to be delayed with respect to the fundamental \dot{V}_{O_2} rise that occurs at exercise onset, the degree of overlap between the confidence limits of the (usually continuing) phase II exponential and the additional \dot{V}_{O_2} increase is considerable. Furthermore, Whipp and Rossiter (2005) illustrate a ten-compartment model for the fundamental \dot{V}_{O_2} component that incorporates a wide range of τ and/or G values and, nevertheless, differs only subtly (and, therefore, with inherent noise, is functionally indistinguishable from) a single exponential (Brittain *et al.*, 2001; Whipp and Rossiter, 2005; Whipp *et al.*, 2005; see Figure 9.3). This means that considerable metabolic response heterogeneity in a recruited pool during a U→H transition could be hidden within what might be an oversimplified model comprising a fundamental exponential and singular delayed-onset supplemental phase (see Figure 2.11).

An interesting finding in Chapter 4 that has resonance with this speculation is that the amplitude of the \dot{V}_{O_2} slow component was reduced for M→S Unprimed compared to U→S. This coheres with a previous report for M→H high-intensity exercise (Wilkerson and Jones, 2006) and is, at face value, counterintuitive on numerous fronts. For example, given the likelihood that higher-order fibres play a prominent role in each of the slow component delayed-onset scenarios advanced above, a reduction in association with a model that

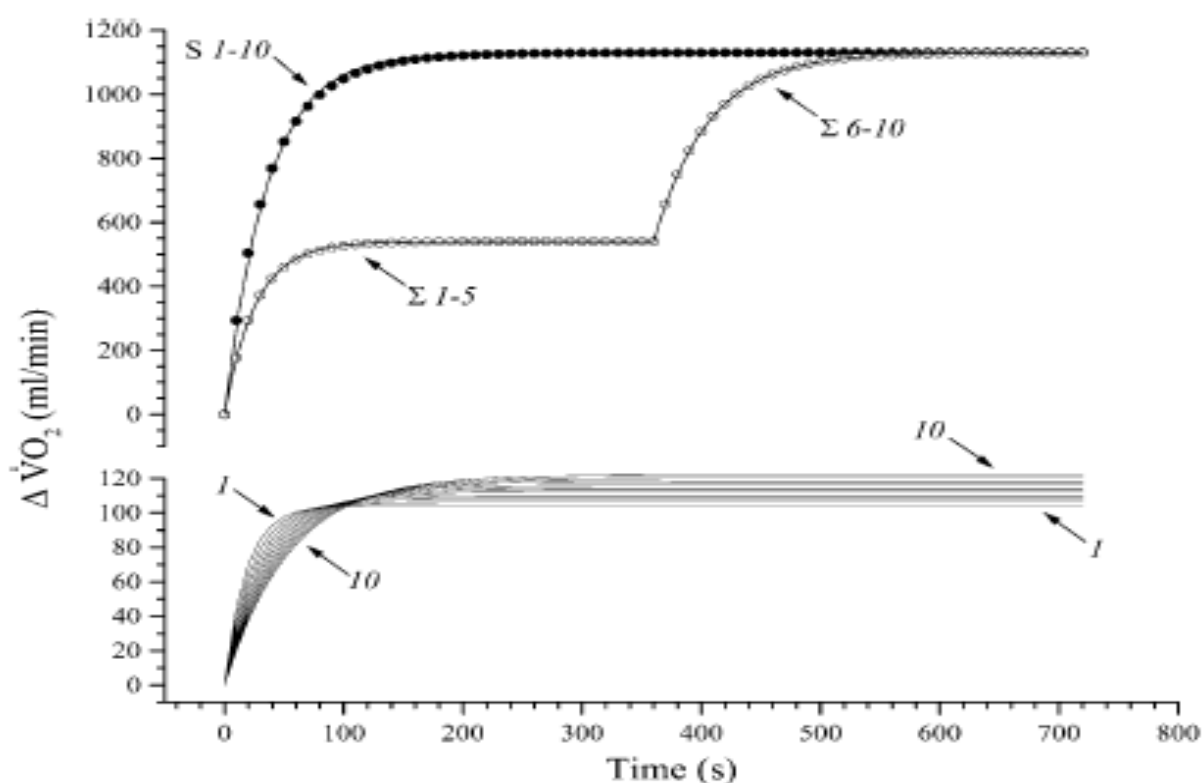

Figure 9.3: A schematic illustration of how a ten-compartment response model comprising input from muscle fibres expressing a range of τ and G values can present a 'mean response profile' that is functionally indistinguishable from a monoexponential response. In this case, the model is used to explain why transitions in the upper region of the moderate domain (i.e., comprising input from motor units 6-10; see upper panel) are characterised by a lengthened τ_p compared to transitions in the lower moderate region. When all fibres are included in one full transition (bottom panel), an intermediate value for τ_p is present for the 'monoexponential' response profile that is observed. Reprinted from Brittain *et al.* (2001).

isolates the response characteristics of these fibres (see above) is difficult to reconcile. Furthermore, unlike the ~43% slow component reduction that was observed for M→S Primed compared to M→S Unprimed in the same investigation, this ~24% reduction occurred in the absence of a significant change in $\Delta iEMG_{(6-2)}$ (see Chapter 4, Figure 5). It is also unlikely that this would reflect a priming effect because prior research indicates that the intensity of a priming bout must be sufficient to result in residual metabolic acidosis (i.e., be performed above the GET) (Gerbino *et al.*, 1996; Burnley *et al.*, 2000) and the

elevated baseline that M→S Unprimed was initiated from (90% GET) would not fulfil this requirement. Finally, compared to U→S, MRT was actually ~16% *longer* for M→S Unprimed, which contrasts the prior-exercise effect and is consistent with the notion that the ‘slow response’ characterising U→S was still present, but in ‘reclassified’ form.

If the slower phase II \dot{V}_{O_2} response during M→H exercise reflects redefinition of the phase by a more homogenous group of high-order fibres with slower \dot{V}_{O_2} kinetics (Wilkerson and Jones, 2006; Wilkerson and Jones, 2007; see above), the multi-compartment model suggested by Whipp and Rossiter (2005) would be ‘stretched’ to the right and, therefore, able to accommodate longer τ values compared to the range covered when lower-order fibres predominantly defined the exponential (e.g., during similar transitions initiated from an unloaded baseline). Conversely, if U→H transitions typically required the initial activation of a much more heterogeneous pool including higher-order fibres with extremely long τ values, these profiles might project past the range that comprised the best-fit phase II exponential under these circumstances, thereby ‘creating’ a response phase that appeared to be of delayed onset (or at least adding to the delayed-onset component that is attributable to the mechanisms speculated upon above). A slow component reduction during M→H could, therefore, simply reflect reclassification of this segment of the slow component during U→H to the response phase where it rightfully belongs (Wilkerson and Jones, 2006; see Chapter 2; Theory 5 on pg. 85).

The speculation above suggests that the work-to-work model discriminates aspects of the slow component that are based upon changes that occur as exercise proceeds (i.e., serial recruitment of additional muscle fibres and/or a progressive loss of contractile efficiency; see above) from those that are attributable to response heterogeneity in initially-recruited

fibres. Wilkerson and Jones (2006) suggest that this distinction might be intensity dependent. For example, they speculate that during heavy exercise, the slow component might predominantly reflect response heterogeneity, whereas once CP is exceeded, time-dependent changes also contribute. This would explain why \dot{V}_{O_2} reaches an (albeit elevated) steady state in the former case, but rises inexorably until exhaustion in the latter (Poole *et al.*, 1988). Furthermore, this model would predict that during an M→H transition to heavy exercise, the slow component would be eliminated completely. Interestingly, Wilkerson and Jones (2006) found that to be the case for three of their seven subjects during M→H transitions to 40% Δ , which is an intensity that should be close to CP for most subjects (Poole *et al.*, 1988; Wilkerson *et al.*, 2004c). It is, therefore, possible that for those three individuals, the relative challenge during these transitions was sufficiently sustainable (non-exhaustive; i.e., below CP) so as to mandate no delayed-onset changes in fibre activation or contractile efficiency as exercise progressed.

A slow component comprising sluggish response profiles of initially-active fibres might also explain the presence of a ‘delayed-onset’ \dot{V}_{O_2} rise without iEMG increase during high-intensity cycling at 35 rev·min⁻¹ (Chapter 7). For example, compared to 115 rev·min⁻¹, τ_p values for U→M, U→H and M→H spanned a far narrower range at the slow cadence (see Chapter 7, Figure 4) which, in accordance with the speculation above, is consistent with the notion that a more homogenous group of low-order fibres defined the phase II exponential under these circumstances (i.e., when contraction frequency did not favour fibres with faster-twitch characteristics). Consequently, profiles of higher-order fibres that had to be recruited at exercise onset would not be accommodated within phase II and a slow component would be created by response heterogeneity. Conversely, despite the similar relative intensity at the different pedal rates (60% cadence-specific Δ), the slow component

could lack a delayed-onset segment under these circumstances because the fatigue as exercise proceeds is less. Indeed, the significantly lower $\Delta_{\text{blood}} [\text{lactate}]$ that was observed during high-intensity cycling at 35 compared to 115 $\text{rev}\cdot\text{min}^{-1}$ supports the notion that cycling at the slow pedal rate engendered less metabolic stress.

Following this line of reason, during high-intensity cycling at 115 $\text{rev}\cdot\text{min}^{-1}$, fibre recruitment was skewed toward fatigue-sensitive higher-order fibres such that the delayed-onset aspects of the slow component would be present. However, this skewing would also result in a marked slowing of the phase II exponential (e.g., τ_p of ~ 48 and ~ 53 s for U \rightarrow H and M \rightarrow H, respectively), which would allow the response profiles of initially-recruited higher-order fibres to be accommodated and, therefore, isolated out of the slow region. The end result would be what was observed – a slow component of similar magnitude at extreme cadences despite the absence and presence of a delayed-onset iEMG increase at 35 and 115 $\text{rev}\cdot\text{min}^{-1}$, respectively.

If this model is correct and cadence extremes discriminate two different aspects of the \dot{V}_{O_2} slow component, it might be reasonable to suggest that high-intensity cycling at mid-range pedal rates (at least above CP) would comprise both constituents. However, in such a bout, the reduced $\Delta_{\text{blood}} [\text{lactate}]$ that is typically observed after priming (e.g., see M \rightarrow S exercise in Chapter 4) would be consistent with reduced fatigue, possibly due to more favourable initial fibre recruitment (Burnley *et al.*, 2002a; Burnley *et al.*, 2005). According to the speculation above, this would approximately halve the slow component amplitude (i.e., facilitate the characteristic prior-exercise effect) by eliminating the delayed-onset segment. Completing the circle, therefore, the fact that the slow component is reduced, but not eliminated (i.e., the ‘half’ reflecting response heterogeneity is still present) after

priming supports the notion that priming does not accelerate sluggish phase II \dot{V}_{O_2} kinetics in higher-order fibres under normal circumstances (see Figure 9.2) because if it did, the more homogenous initial response would allow for a slow-to-primary amplitude shift (and consequent further reduction or elimination of the slow component) for at least some of these initially-recruited fibres.

Further evidence that the two (post-phase-I) compartment \dot{V}_{O_2} response to high-intensity exercise might misrepresent more complex underlying physiology comes from previous findings of the effect of a supine body posture on \dot{V}_{O_2} kinetics during U→H cycling. While it is well established that a slower *overall* \dot{V}_{O_2} response is present under these circumstances (Cerretelli *et al.*, 1977; Leyk *et al.*, 1992; Koga *et al.*, 1999; Denis and Perrey, 2006; Jones *et al.*, 2006), a common consensus regarding the precise location of the slowing from those investigations that partitioned \dot{V}_{O_2} kinetics into discrete components is lacking. For example, at the same absolute work rate, Koga *et al.* (1999) found a reduction in the amplitude of the phase II response and an increase in the amplitude of the slow component during supine cycling with no significant difference in τ_p . Conversely, Jones *et al.* (2006) observed no change in either response-phase amplitude, but a lengthened τ_p (on average, ~31%) during supine cycling at the same absolute work rate, although inter-subject variability precluded attainment of statistical significance. Finally, Denis and Perrey (2006) reported a significantly lengthened τ_p along with an unchanged G_p and slow component relative amplitude at the (approximately) same relative work rate (25 W above posture-specific ventilatory threshold), although the slow component was reduced in absolute terms in that investigation.

New findings from Chapter 6 help to reconcile this prior ambiguity and further suggest that response heterogeneity can blur the distinction between fundamental and slow \dot{V}_{O_2} response phases during U→H transitions. Specifically, the \dot{V}_{O_2} MRT (a parameter that reflects the time course of the entire \dot{V}_{O_2} response) was significantly lengthened when subjects cycled at the same relative intensity (70% posture-specific Δ ; ~97% posture-specific $\dot{V}_{O_{2peak}}$ at minute six) during supine U→H transitions, which supports the previous findings. However, there was no significant difference in either τ_p or G_p /slow component amplitude, and when data were inspected on an individual-subject basis, the reason for this unexpected result became apparent. Consequent to the supine posture, five participants demonstrated a lengthening of τ_p (on average ~40%), whereas G_p was reduced and slow component amplitude increased for three. Furthermore, two of these eight subjects experienced both forms of slowing.

These results indicate that the supine posture (and, presumably, consequent reduction of tissue oxygenation) can exert its influence during U→H by lengthening τ_p and/or shifting response-phase amplitudes, with the specific effect(s) dependent upon the subject being tested. However, during supine M→H, τ_p was lengthened in all eight subjects. This is consistent with the notion that a slower initial response in higher-order fibres was responsible for the slowing in both circumstances regardless of how it manifested during U→H where increased fibre-type diversity created greater complexity in the homogenised pulmonary signal. This inability to differentiate between τ_p changes and reciprocal amplitude shifts during U→H might also explain contrasting findings that have previously been reported regarding the effect of priming on \dot{V}_{O_2} kinetics. For example, while the vast majority of studies suggest that the characteristic prior-exercise effect (i.e., the priming effect under normal exercise conditions) does not include an accelerated phase II response,

Tordi *et al.* (2003) reported that prior multiple-sprint cycling resulted in a significant reduction of τ_p from ~ 29 to ~ 22 s during severe-intensity cycling. Given the present findings that fast-cadence cycling (which is similar to sprint cycling) reduced τ_p during subsequent U \rightarrow H cycling by increasing O₂ utilisation (i.e., decreasing metabolic inertia) in higher-order fibres (see X_n \rightarrow X_{fp} on Figure 9.2), this result should not be surprising. However, in other studies that demonstrated a sprint-priming-induced acceleration of the overall \dot{V}_{O_2} response, τ_p was unchanged and amplitude changes (specifically, a slow-to-primary shift and projection to a higher asymptote during heavy/severe and supramaximal cycling, respectively) took place (Burnley *et al.*, 2002b; Wilkerson *et al.*, 2004b). In light of the speculation presented above, it is possible that these amplitude alterations do reflect τ_p shortening, which would also be consistent with what has been reported for amphibian and mammalian muscle following prior contractions (i.e., an accelerated fall in microvascular PO₂ that is consistent with decreased metabolic inertia) (Hogan *et al.*, 2000; Behnke *et al.*, 2002b).

\dot{V}_{O_2} slow component: directions for future research

In the preceding sections, three distinct mechanisms have been suggested that might potentially underpin the \dot{V}_{O_2} slow component under different circumstances during high-intensity exercise. Although consistent with past and present findings, much of this is speculative and requires validation. For example, the conjecture regarding what the slow component reflects for severe compared to heavy exercise can be explored by defining exercise intensity relative to CP instead of Δ when investigating the phenomenon. In this regard, it is interesting to note that of the 26 studies that have used electromyography and/or magnetic resonance imaging to examine the relationship between fibre activation and the \dot{V}_{O_2} slow component during constant-load exercise (the 22 listed in Tables 2.3 and

2.4, and the four included in the experimental chapters of this thesis), only one (Garland *et al.*, 2006) performed CP testing to precisely define the intensity of the exercise bouts that they were assessing (in that case, heavy). This is, perhaps, understandable, given that heretofore, CP determination required that subjects perform multiple (e.g., 4-6) constant-work-rate exercise bouts to exhaustion on separate days to establish their power/time hyperbola (Poole *et al.*, 1988). Obviously, this testing regime would have to be completed prior to even beginning the experimental portion of an investigation (i.e., constant-load tests definitively above and/or below CP for simultaneous $\dot{V}O_2$ and fibre activation measurement); therefore, its use for this purpose would be difficult to manage. However, it has recently been shown that a single, three-minute all-out cycling test against a fixed resistance can be used to accurately predict CP by expending the finite capacity for work above CP prior to end exercise (Vanhatalo *et al.*, 2007; Vanhatalo *et al.*, 2008). Employing this test and subsequent sub- and supra-CP constant-load tests with electromyographic or MRI measurement is an important direction for future research because it could provide a way to determine if muscle activation patterns are different during heavy- and severe-intensity exercise.

The distinction (or lack thereof) between the primary and slow response phases is another aspect of the slow component that should be investigated more in the future. This can be explored by using work-to-work transitions and pedal rate extremes in conjunction with other interventions that have been shown to alter either τ_p or response-phase amplitudes. These include hypoxic gas inspiration (increased τ_p , unaltered amplitudes; Engelen *et al.*, 1996), hyperoxic gas inspiration (no change in τ_p , decreased slow component, unchanged or increased primary amplitude; MacDonald *et al.*, 1997; Wilkerson *et al.*, 2006) and

sodium bicarbonate ingestion (no change in τ_p or primary amplitude, 'reduced' slow component – i.e., $P = 0.08$; Berger *et al.*, 2006).

Limitations to the present research*Confidence in modelled $\dot{V}O_2$ kinetics parameter estimates*

By far, the most restrictive limitation in virtually all $\dot{V}O_2$ kinetics investigations is the challenge to achieve sufficient confidence in parameter estimates derived from modelled fits. For example, Hughson (2005) questions the ability to resolve “real differences” in τ_p values due to breath-to-breath variability in the pulmonary $\dot{V}O_2$ signal and cites evidence to suggest that as much as a 40% difference in τ_p might not be considered significant. This means that conclusions that an intervention does not alter τ_p must be drawn with caution (Hughson, 2005). As is standard in this field of research, attempts were made to enhance signal-to-noise ratio prior to modelling data in this thesis (see Chapter 3); however, M→H transitions provide added difficulty in this regard. For example, it is generally believed that breath-to-breath variability is not influenced by metabolic rate and, therefore, becomes a diminishing portion of the $\dot{V}O_2$ response as amplitude increases (Whipp and Rossiter, 2005). Consequently, large work-rate increments are beneficial for reducing the negative impact that this inherent noise can present. Larger work-rate increments are present when well-conditioned, larger subjects complete transitions that span the greatest possible work-rate range given the restrictions imposed by the intensity domain being studied (e.g., 20-W cycling to 95% GET and 20-W cycling to 70% Δ for U→M and U→H, respectively). However, by their very nature, M→H transitions will necessitate a reduced range due to the elevated baseline.

M→H transitions are also problematic because it is difficult to counter this reduced work-rate range. For example, a similar range will typically be spanned during U→M transitions due to the ceiling imposed by GET; however, in this case, because the exercise only presents a moderate challenge, repeat trials can be performed after a relatively short

rest period on the same day. Consequently, the fact that breath-to-breath variability will comprise a greater portion of the response amplitude during U→M can be countered by averaging more repeat trials. Conversely, it is not advisable to perform multiple high-intensity transitions on a single day; therefore, it is difficult to envision a testing regimen that would allow for more than three repeat trials of any M→H transition, especially when multiple conditions (e.g., upright, unprimed supine and primed supine; Chapter 6) are being assessed. It is also necessary to consider the possibility that a training effect might occur if too many repeat transitions of high-intensity exercise are performed (Phillips *et al.*, 1995). Such a change over time would confound the purpose of ensemble averaging, which is to use ‘like transitions’ to smooth the data. Finally, an even greater challenge was present during M→H at 115 rev·min⁻¹ (Chapter 7) because breath-to-breath variability for a given subject was typically greater at this rapid cadence. U→M and U→H at 115 rev·min⁻¹ (Chapters 7 and 8) were also adversely affected in this regard and a further difficulty with these transitions was that they are characterised by reduced response amplitudes due to the increased $\dot{V}O_2$ requirement of the unloaded cycling baseline.

Use of electromyographic data to infer motor unit activation

All of the findings regarding motor unit activation in this thesis are based upon inferences drawn from electromyographic data collected during exercise. There are problems associated with this approach. For example, despite the filtering process that was employed (see Chapter 3), inherent noise might still be present in the signal and this could make it difficult to establish a relationship between this variable and another one that is fraught with measurement variability such as $\dot{V}O_2$ (Jones *et al.*, 2005). For example, while it is reasonable to suggest that the reduction in the $\dot{V}O_2$ slow component that was observed after priming in Chapter 4 resulted from the reduced $\Delta iEMG_{(6-2)}$, these changes were not

significantly correlated ($r = 0.28$; $P > 0.05$). Furthermore, it is possible that muscle fibre recruitment patterns will vary across different muscles with the passage of time during high-intensity exercise (Jones *et al.*, 2005). This would confound the association between an iEMG measurement that is based solely upon one muscle (or even two; e.g., Chapter 7) and $\dot{V}O_2$ measured at the lung during exercise like cycling where a relatively large number of muscles are contributing to power production. It is also important to note that the iEMG signal does not differentiate between motor unit recruitment and rate coding in active fibres; therefore, the more generic “motor unit activation” has been referred to within this thesis. Consequent to all of these limitations, Jones *et al.* (2005) suggest that the results of $\dot{V}O_2$ kinetics studies that include EMG assessment should be interpreted carefully and that warning is duly heeded.

Use of near-infrared spectroscopy data to infer muscle O_2 extraction

A number of methodological concerns exist with regard to the use of NIRS to infer fractional muscle O_2 extraction and, therefore, changes that might be precipitated by a specific intervention (e.g., priming or the supine posture, Chapters 6 and 8) during exercise. For example, it is presently unclear whether NIRS optical parameters (e.g., the differential path length factor and the degree of light scattering) change during constant-load exercise. If they do, this could make it difficult to confidently quantify absolute changes in O_2 extraction resulting from an intervention (e.g., priming exercise; Chapters 6 and 8). While ΔHHb was normalised to $\dot{V}O_2$ so that O_2 extraction in *relative* terms could be compared within this thesis, if these factors were different across different interventions (e.g., extreme pedal rates, body position and/or priming), this comparison would be affected. Furthermore and similar to EMG, NIRS data within this thesis only reflect changes within one muscle contributing to power production (vastus lateralis); therefore, comparisons with

whole-body $\dot{V}O_2$ should be made judiciously. Finally, it is important to note that NIRS data only reflect changes within the superficial area of the muscle under interrogation and there is evidence to suggest considerable spatial heterogeneity in the NIRS response at different measurement sites on the quadriceps muscle during cycle exercise (Koga *et al.*, 2008).

Conclusions

Hypothetical model: fibre-type diversity and $\dot{V}O_2$ kinetics

The hypothetical model that follows depicts a proposed effect of fibre-type diversity on $\dot{V}O_2$ kinetics. It employs the same schematic representation of muscle fibres that was presented previously (see Figure 2.8) and is based upon the present findings in conjunction with suppositions that have been advanced previously to explain $\dot{V}O_2$ deviations from linearity during work-to-work exercise (Brittain *et al.*, 2001; Wilkerson and Jones, 2006; Wilkerson and Jones, 2007). The model is constructed in accordance with the following general assumptions:

- The population of muscle fibres available for recruitment within an active muscle during cycle ergometer exercise comprises an array that express different oxidative metabolic properties (e.g., τ and G) (Crow and Kushmerick, 1982).
- While myofibrillar ATPase activity provides a general way to classify fibre types according to myosin heavy chain isoform, there is a wide range of aerobic/anaerobic enzymatic variation within these groupings (Staron, 1997). Consequently, progression through the recruitment hierarchy (Henneman *et al.*, 1965) spans fibres with a range of oxidative response characteristics that are better described along a continuum (Bottinelli and Reggiani, 2000).
- The force exerted on the pedals during a square-wave transition to supra-GET cycle ergometer exercise (e.g., from 20-W cycling to 60-70% Δ) requires the initial activation of both type I and type II (at least IIa and possibly IIx) muscle fibres (Vøllestad *et al.*, 1984; Vøllestad and Blom, 1985; Krstrup *et al.*, 2004b).
- The force exerted on the pedals during supra-GET cycle ergometer exercise (e.g., at 60-70% Δ) requires the initial (and also, possibly, delayed-onset) activation of a pool

of fibres of sufficient expense so as to traverse a considerable range of oxidative response heterogeneity (Wilkerson and Jones, 2006).

Figure 9.4 illustrates the full pool of muscle fibres assumed to be available for recruitment in a prime mover muscle during cycle ergometer exercise. As was the case in Figure 2.8, fibres are represented by horizontal bars, the heights of which indicate their place along the recruitment hierarchy. Also similar to Figure 2.8, oxidative/non-oxidative capacity of the various fibre types is indicated by the red and blue shadings, respectively, and the $\dot{V}O_2$ response profiles specific to fibres residing along the continuum are indicated in the boxes

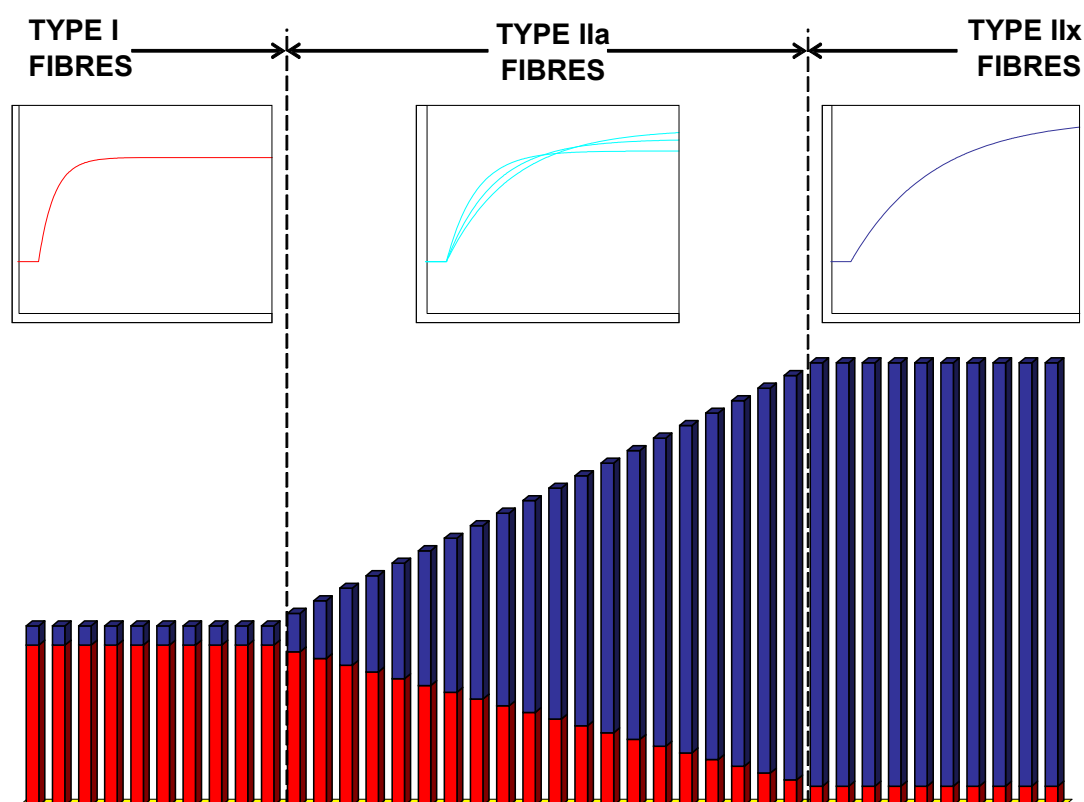

Figure 9.4: The full pool of muscle fibres available for recruitment in a prime mover muscle during cycle ergometer exercise and associated oxidative response profiles.

above. For clarity, these characteristics are assumed to be homogenised at extreme ends of the spectrum and only to be variable in mid-range. However, as indicated in Figure 2.8 and suggested by Brittain *et al.* (2001), it is possible that even the type I fibre pool includes some degree of metabolic diversity. Furthermore, while a three-group classification system is used for simplicity, as noted previously for the fibre-type-specific tipping point, more gradual gradations in metabolic function from one end of the spectrum to the other might very well also render this depiction something of an oversimplification.

Hypothetical construct 1: \dot{V}_{O_2} response to moderate-intensity exercise

When a transition to moderate-intensity cycle exercise is initiated from a baseline of unloaded (i.e., 20 W) cycling, the response characteristics of a relatively homogenous group of low-order fibres will define the pulmonary \dot{V}_{O_2} response. These fibres operate well within the O_2 -independent zone (Chapter 6 and see Figure 9.2), so their response inertia is dictated by processes occurring within the cell (i.e., the critical rate modulator; e.g., [PCr]/creatine kinase dynamics; Chapter 5) and their τ is as short as possible given their present metabolic capacity (e.g., trained versus untrained state). Figure 9.5 depicts this response.

Hypothetical construct 2: \dot{V}_{O_2} response to heavy-intensity exercise

When a transition to heavy-intensity cycle exercise is initiated from a baseline of unloaded (i.e., 20 W) cycling, the response characteristics of a more heterogeneous group of fibres will define the pulmonary \dot{V}_{O_2} response. Consequently, some of the fibres will have longer τ_p values, although metabolic inertia (e.g., greater [PCr] and/or slower response kinetics in oxidative enzymes) still modulates their response. This sluggish response results in both a slowing of phase II (which combines some of the high-order responders' profiles with

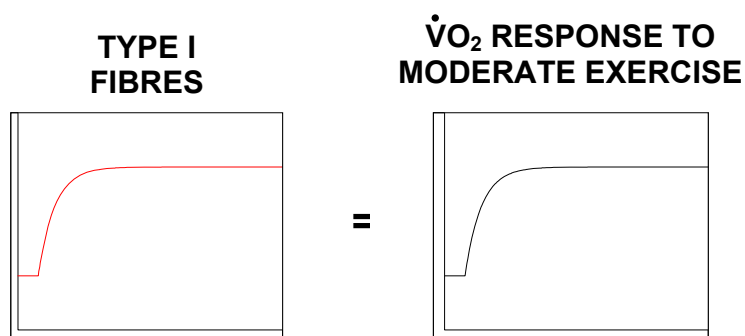

Figure 9.5: The pool of muscle fibres recruited in a prime mover muscle during cycle ergometer moderate-intensity exercise and associated oxidative response profile.

those of lower-order fibres; see above) and a protracted rise that separates from the best-fit exponential established by the more homogenised lower group. Consequently, a $\dot{V}O_2$ slow component is 'created' with unchanged indices of motor unit activation (i.e., absence of a positive $\Delta iEMG$, Chapter 7). $\dot{V}O_2$ will eventually achieve a steady state once these sluggish responses come to fruition; however, the overall G will be greater than during moderate exercise because it will represent the phase II response of all involved fibres (low-order fibres and higher-order ones that require more ATP per contractile tension developed). Figure 9.6 depicts this response.

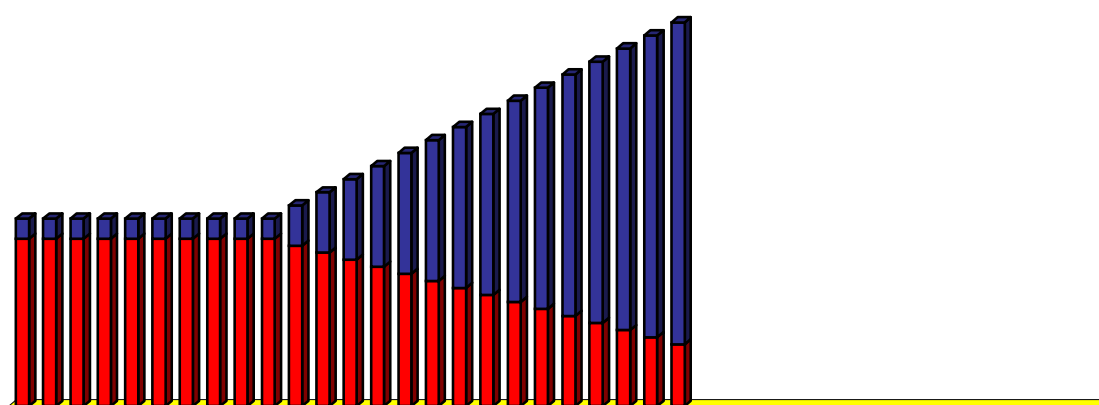
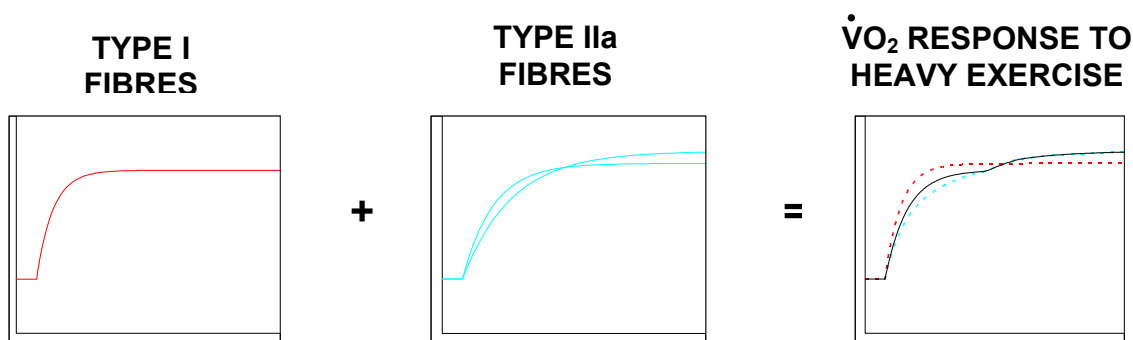

Figure 9.6: The pool of muscle fibres recruited in a prime mover muscle during cycle ergometer heavy-intensity exercise and associated oxidative response profile.

Hypothetical construct 3: \dot{V}_{O_2} response to severe-intensity exercise

When a transition to severe-intensity cycle exercise is initiated from a baseline of unloaded (i.e., 20 W) cycling, the response is initially similar to what occurs during heavy-intensity cycling, although a greater drive through the recruitment hierarchy mandates the involvement of fibres that are more sensitive to fatigue. Additional delayed-onset fibre activation (i.e., a positive $\Delta iEMG$; Chapters 4, 5, 6 and 7, but see at 35 rev·min⁻¹ in Chapter 7) and a commensurate inexorable rise in \dot{V}_{O_2} are requisite consequences of this involvement. The magnitude of the \dot{V}_{O_2} slow component is, therefore, greater than during

heavy cycling (assuming exercise can proceed long enough to allow it to manifest) because it includes two different elements – the protracted phase II response profiles of higher-order fibres and the delayed-onset changes that occur during fatiguing exercise (i.e., the phase II response profiles of fibres that are activated during exercise and possibly an extra O_2 cost associated with an increased ATP cost of tension development with increasing fatigue).

Figure 9.7 depicts this response.

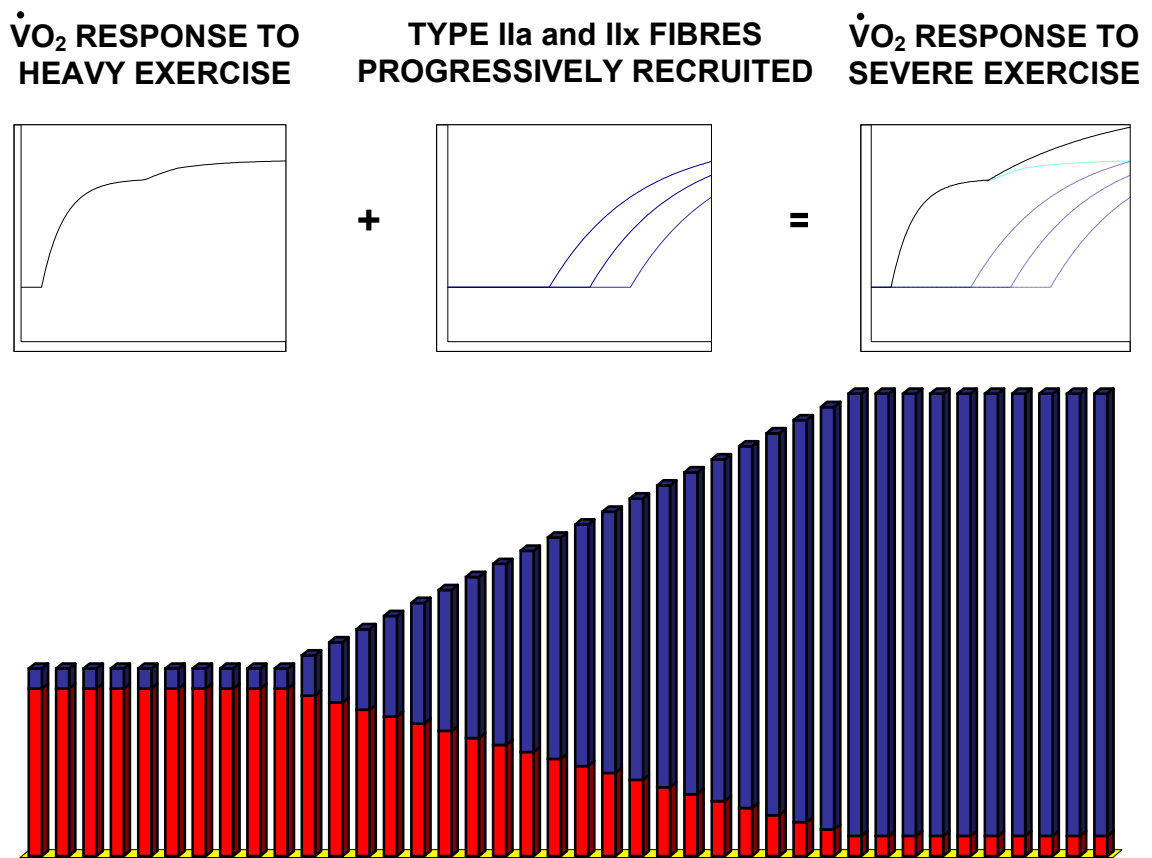

Figure 9.7: The pool of muscle fibres recruited in a prime mover muscle during cycle ergometer severe-intensity exercise and associated oxidative response profile.

Hypothetical construct 4: \dot{V}_{O_2} response to work-to-work exercise

When a transition to severe-intensity cycle exercise is initiated from a baseline of moderate-intensity cycling, low-order fibres that are involved in the full severe transition (see above) are no longer included. Consequently, the response characteristics of a more homogenous group of fibres will define the pulmonary \dot{V}_{O_2} response and phase II will be 'reclassified' because the best-fit exponential is no longer established by fibres responding with a shorter τ and lesser G. This results in a lengthened phase II τ for M→H v. both U→M (Chapters 5, 6 and 7) and U→H (Chapter 4 and 6; but see at extreme pedal rates, Chapter 7) transitions. Furthermore, the \dot{V}_{O_2} slow component will also be redefined because only the delayed-onset element will still be present. Consequently, slow component amplitude will be reduced (Chapter 4; but see at extreme pedal rates in Chapter 7), even though both elements that comprise it are still present (i.e., $\Delta iEMG$ is still positive; Chapter 4). Figure 9.8 depicts this response.

Hypothetical constructs 1-4: summary

Figure 9.9 provides a summary of hypothetical constructs 1-4. In addition to the present body of work, this model helps to explain the following previous findings:

- a phase II τ that is longer for full heavy-/severe- compared to moderate-intensity transitions (for review, see Poole and Jones, 2005);
- a phase II G that is reduced when a \dot{V}_{O_2} slow component is present (Wilkerson *et al.*, 2004c);
- an end-exercise G that is increased when a \dot{V}_{O_2} slow component is present (Linnarsson, 1974; Whipp and Mahler, 1980; Barstow and Mole, 1991);

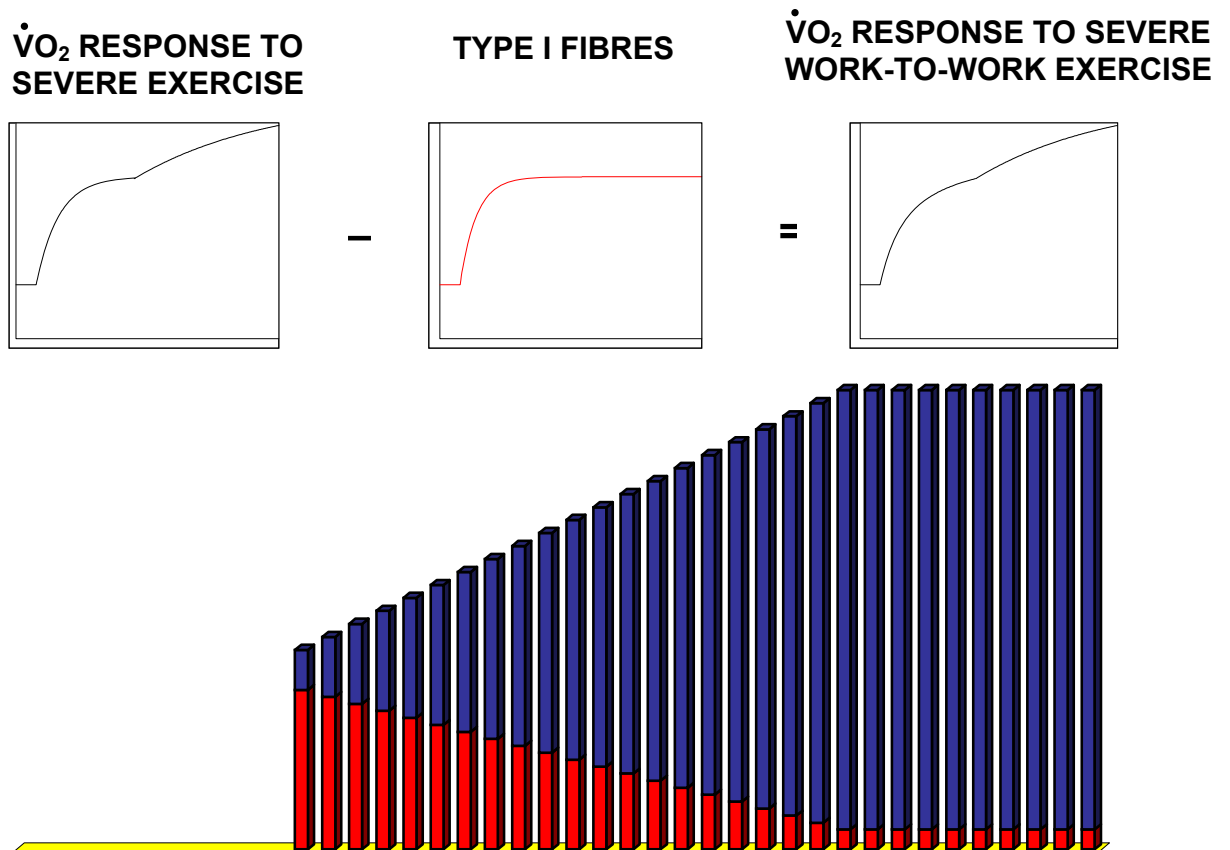
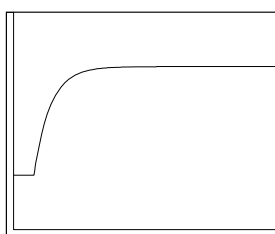

Figure 9.8: The pool of muscle fibres recruited in a prime mover muscle during cycle ergometer severe-intensity exercise initiated from a moderate-intensity baseline and associated oxidative response profile.

- a phase II τ that is longer for work-to-work compared to full heavy-/severe-intensity transitions (Wilkerson and Jones, 2006);
- a \dot{V}_{O_2} slow component that eventually stabilises at a submaximal \dot{V}_{O_2} steady state during heavy-intensity exercise (Poole *et al.*, 1988);
- no delayed-onset fibre activation during heavy-intensity exercise (Garland *et al.*, 2006);
- a \dot{V}_{O_2} slow component that does not stabilise and forces \dot{V}_{O_2} to its maximum attainable value during severe-intensity exercise (Poole *et al.*, 1988);

- delayed-onset fibre activation during high-intensity exercise (Saunders *et al.*, 2000; Perrey *et al.*, 2001; Burnley *et al.*, 2002; Saunders *et al.*, 2003; Sabapathy *et al.*, 2005; Endo *et al.*, 2007; Bailey *et al.*, 2010);
- a $\dot{V}O_2$ slow component that is decreased for work-to-work compared to full heavy-/severe-intensity transitions (Wilkerson and Jones, 2006).

$\dot{V}O_2$ RESPONSE TO MODERATE EXERCISE



$\dot{V}O_2$ RESPONSE TO SEVERE EXERCISE

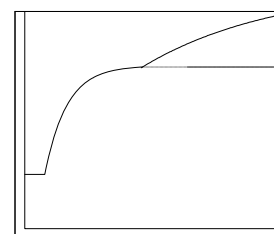

$\dot{V}O_2$ RESPONSE TO HEAVY EXERCISE

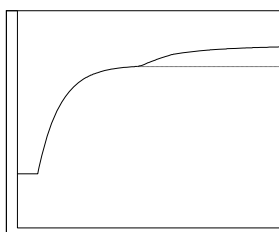

$\dot{V}O_2$ RESPONSE TO SEVERE WORK-TO-WORK EXERCISE

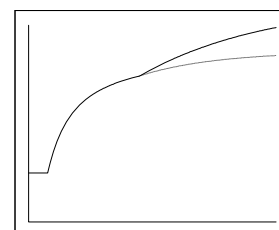

Figure 9.9: A summary of hypothetical constructs 1-4. See text for further details.

Hypothetical model: intervention-induced alterations in $\dot{V}O_2$ kinetics

To examine the influence of muscle fibre recruitment on $\dot{V}O_2$ kinetics within the context of the hypothetical model being advanced, findings within this thesis were based upon work-

to-work exercise transitions performed in conjunction with acute interventions that have been shown to influence \dot{V}_{O_2} kinetics. These included high-intensity priming (i.e., exercise that elicits the characteristic prior-exercise effect; Burnley *et al.*, 2000; Burnley *et al.*, 2001; Koppo and Bouckaert, 2001; Scheuermann *et al.*, 2001; Burnley *et al.*, 2002a; Burnley *et al.*, 2002b; Endo *et al.*, 2005; Bailey *et al.*, 2010; see Figure 2.5), supine body position (Koga *et al.*, 1999; Denis and Perrey, 2006; Jones *et al.*, 2006) and extremely slow and fast pedal cadences (Pringle and Jones, 2003b; Migita *et al.*, 2006; Vercruyssen *et al.*, 2008; see Table 2.2). Specifically, the degree to which intervention-induced alterations are fibre-type specific was explored.

Hypothetical construct 5: \dot{V}_{O_2} response to primed exercise

Through use of the hypothetical model, Figures 9.10 and 9.11 depict how the characteristic effect elicited by priming (reciprocal amplitude shift with unchanged τ_p ; see Figure 2.5) might be explained by two distinctly different mechanisms. As has been previously suggested, the unchanged τ_p could provide evidence that no fibres involved in the transition have had their primary response phase accelerated (Burnley *et al.*, 2005; Poole *et al.*, 2008). However, if at least part of the \dot{V}_{O_2} slow component represents the protracted primary response profiles of initially-recruited higher-order fibres (see above), shortening τ_p in these fibres could manifest as a slow-to-primary amplitude shift if τ_p was reduced to a value similar to τ_p for the low-order fibres that were defining the best-fit phase II exponential under those circumstances (i.e., during a transition from unloaded cycling). In this case, removal of the faster-responding fibres within the work-to-work paradigm would result in a 'reclassification' of phase II that should allow this priming-induced τ_p reduction to be identified (Figure 9.10). Conversely, if priming elicits the same amplitude shift during work-to-work transitions where phase II has been reclassified, the contention that

the amplitude shifts do not represent τ_p shortening and, instead, might reflect altered fibre recruitment (Burnley *et al.*, 2002a; Burnley *et al.*, 2005) would be supported (Figure 9.11) and iEMG evidence indicative of such (a reduced Δ iEMG after priming) would be expected at least under normal exercise conditions (i.e., for exercise without perfusion compromise and/or that does not follow a priming bout comprising extremely rapid contraction frequency).

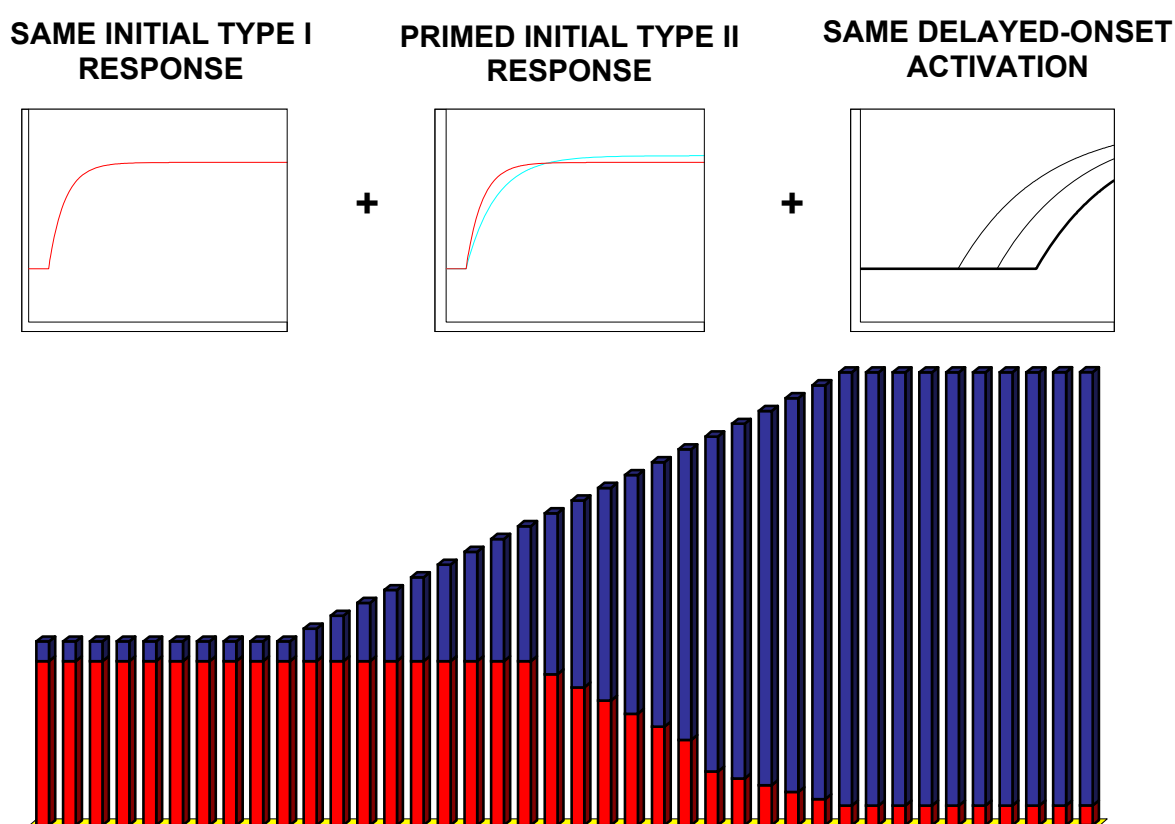

Figure 9.10: Two distinctly different alterations can explain the characteristic prior-exercise effect during full severe exercise transitions. In this case, priming has facilitated oxidative phosphorylation in some sluggish higher-order fibres (see altered red shading) thereby reducing their individual τ_p values so that their response amplitude shifts from slow to primary phase (i.e., the characteristic amplitude shift occurs; see Figure 2.5). To the extent to which priming a work-to-work transition can distinguish this from the other mechanism (depicted in Figure 9.11), results from this thesis refute this explanation under normal exercise conditions.

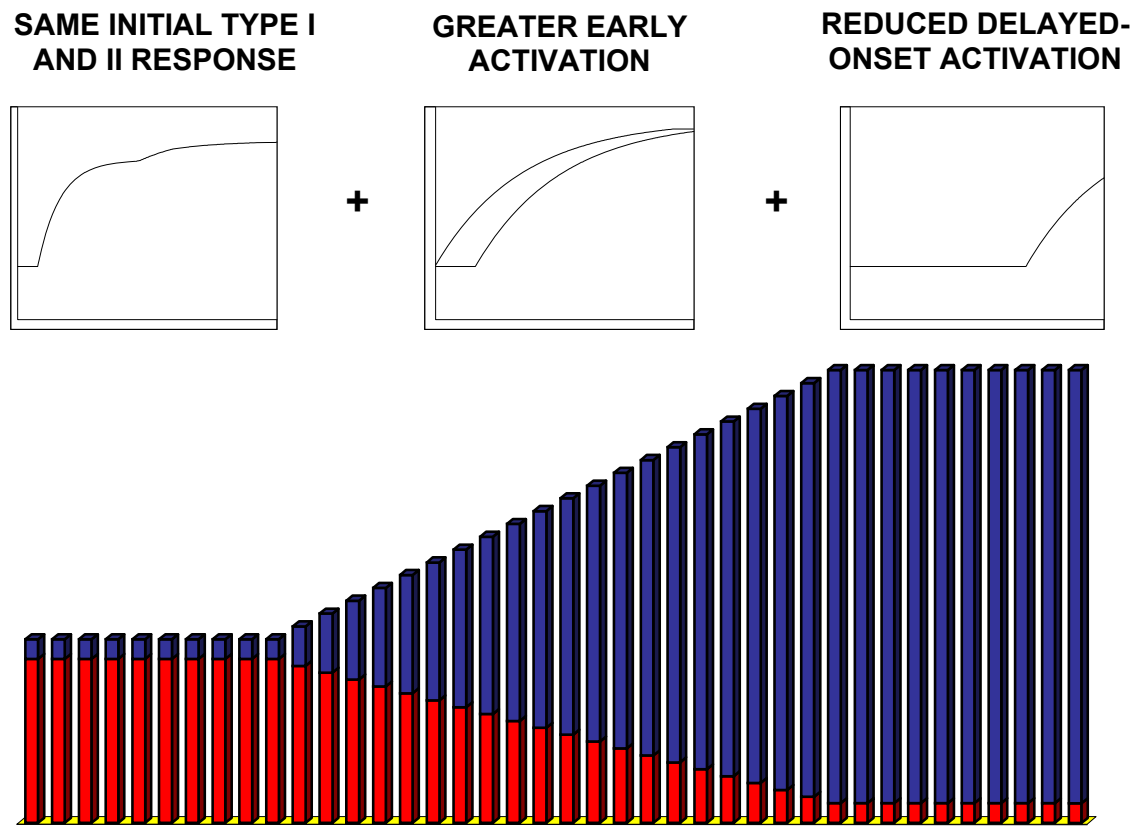

Figure 9.11: Two distinctly different alterations can explain the characteristic prior-exercise effect during full severe exercise transitions. In this case, no actual speeding has taken place and the characteristic amplitude shift (e.g., see Figure 2.5) is solely attributable to a priming-induced alteration in fibre recruitment. To the extent of which priming a work-to-work transition can distinguish this from the other mechanism (depicted in Figure 9.10), results from this thesis support this explanation under normal exercise conditions.

Hypothetical construct 6: $\dot{V}O_2$ response to supine exercise

Performing cycle ergometer exercise in a supine posture with most of the working musculature above heart level reduces perfusion pressure due to removal of the gravitational assist to muscle blood flow (MacDonald *et al.*, 1998; Koga *et al.*, 1999; Jones *et al.*, 2006). Therefore, by comparing $\dot{V}O_2$ kinetics for U→M and M→H supine cycling transitions to that for similar upright cycling (Chapter 6), different susceptibility to decreased tissue oxygenation in discrete fibre types was explored. Through use of the

hypothetical model, Figure 9.12 depicts how findings from Chapter 6 (no effect of body position on $U \rightarrow M$ transitions, but increased τ_p during $M \rightarrow H$ transitions) should be expressed as a reciprocal amplitude shift with unchanged τ_p during $U \rightarrow H$ exercise. Interestingly, this is the effect previously reported by Koga *et al.* (1999) and observed for five of eight subjects in the present data set. However, a reduced τ_p has also been reported previously (Denis and Perrey, 2006; Jones *et al.*, 2006) and this effect was also present either exclusively or in concert with the reciprocal amplitude shift in the present data. This

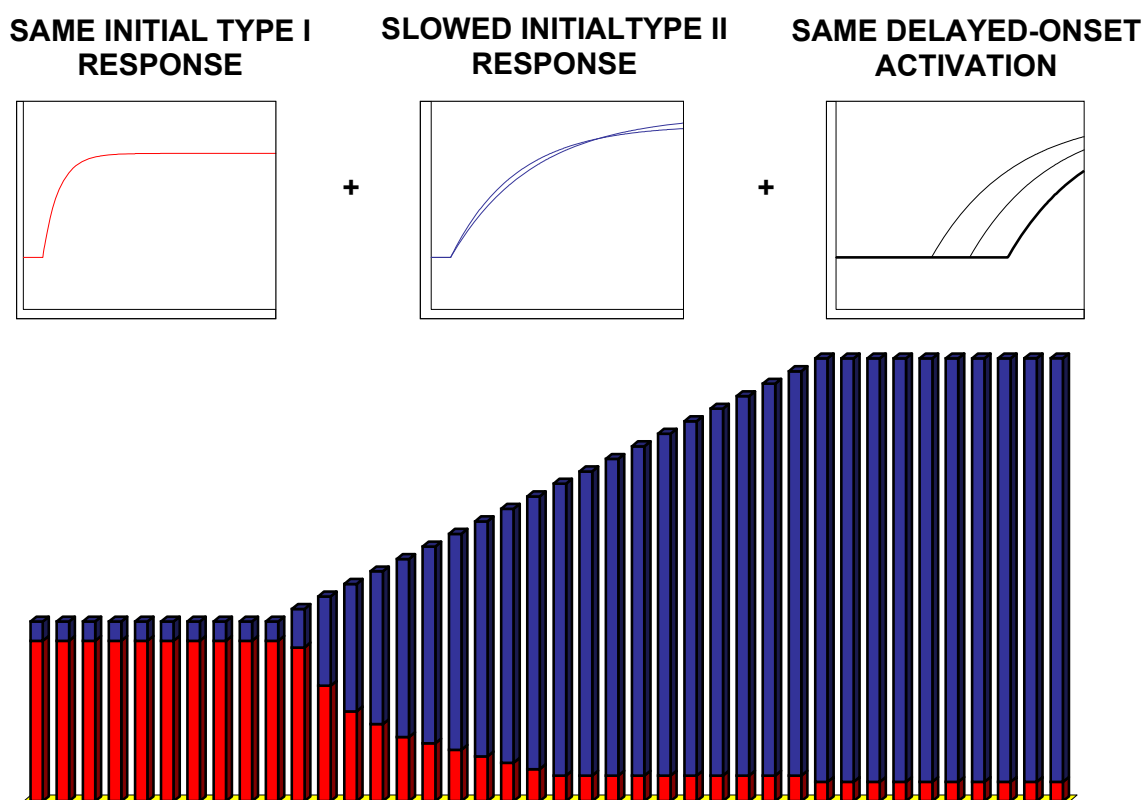

Figure 9.12: Hypothesised effect of supine body posture on $\dot{V}O_2$ kinetics during unloaded-to-severe full transitions based upon the finding that only type II fibres are susceptible to reduced perfusion pressure. Interestingly, this is not the only effect that has been observed in both prior and the present research. See text for further details.

suggests greater complexity regarding the two-compartment response and might reflect fibre-type diversity in different subjects.

Hypothetical construct 7: τ_p relationship for $U \rightarrow M$, $U \rightarrow H$ and $M \rightarrow H$

Given the symmetrical nature of the hypothetical fibre-type recruitment model presented herein, in theory, one would expect a proportional, incremental (i.e., linear with a positive slope) association between τ_p values within a given subject for lower- (shortest τ_p), full- (intermediate and equidistant τ_p) and upper- (longest τ_p) region exercise transitions. For the most part, the individual-subject data reported by Brittain *et al.* (2001) for moderate exercise support such a relationship (see Figure 9.13, Panel A). However, τ_p values observed by Wilkerson and Jones (2006) for $U \rightarrow M$, $U \rightarrow H$ and $M \rightarrow H$ show more variability and clearly skew toward the upper end (personal communication; see Figure 9.13, Panel B) even though workload increments were relatively equal (109 ± 36 W for $U \rightarrow M$, 115 ± 5 W for $M \rightarrow H$). This might indicate that the decrease in oxidative capacity as the fibre recruitment hierarchy is progressed is not symmetrical when the drive for higher-order fibres becomes substantial (e.g., at 40% Δ compared to 90% GET for Wilkerson and Jones *v.* Brittain *et al.*). As is apparent, there is also considerable between-subject variability with respect to this relationship. Although speculative, this variability could be of physiological origin as different subjects would be expected to have fibre-type continuums that are uniquely skewed. For example, an array that is configured in favour of the low-order end might predispose to a full transition τ_p that does not differ substantially from the one characterising the lower transition whereas a greater propensity for high-order fibres might skew the relationship in the opposite direction (e.g., see the individual-subject relationships indicated by the arrows in Figure 9.13, Panels B and A, respectively, for each of these effects). Of course, this is speculative and would have to be confirmed via direct

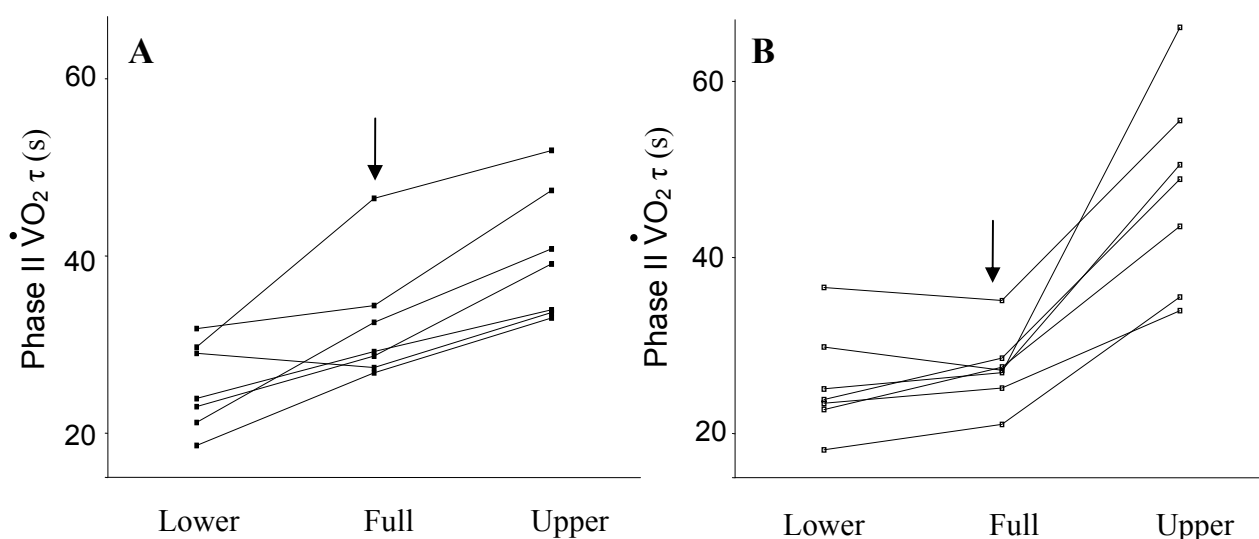

Figure 9.13: Individual subject phase II τ values for lower, full and upper cycle transitions from Brittain *et al.* (2001) (Panel A) and Wilkerson and Jones (2006) (Panel B). Notice how the expected proportionality (a straight line with a positive slope) is skewed in many cases. See text for further details.

measurement of muscle fibre type (e.g., histochemically from muscle biopsy samples); however, it is interesting to note that his inter-subject variability would help to explain the findings of Poole and Jones (2005), who determined that despite a 23% lengthening of the τ_p for U→H compared to U→M across 17 studies that analysed these parameters ($n = 127$), in individual investigations, the difference often failed to attain statistical significance.

Given that extreme pedal rates during cycle exercise should also favour fibre types on opposite ends of the recruitment spectrum, the hypothetical model advanced above would predict that at the same relative exercise intensity, the relationship between τ_p for U→M, U→H and M→H would be altered at extreme pedal rates. This is depicted in Figure 9.14 and is precisely what was found in Chapter 7 (see Figure 4), although at the slow contraction frequency, the intermediate τ_p for U→H was also not significantly different from the M→H value. This ‘overlap’ is likely due to the markedly reduced difference

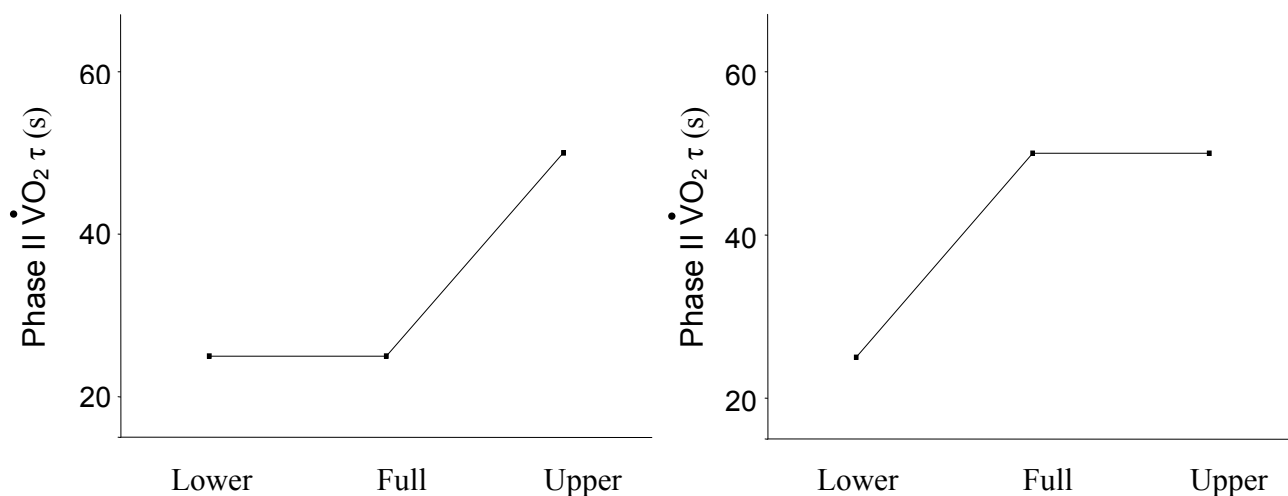

Figure 9.14: Hypothesised effect of extremely slow (left panel) and extremely fast (right panel) pedal rates on the phase II $\dot{V}O_2 \tau$ during unloaded-to-moderate (lower), unloaded-to-high-intensity (full) and moderate-to-high-intensity (upper) cycle ergometer transitions. See text for justifying rationale.

between U→M and M→H extremes at 35 rev·min⁻¹ (i.e., ~9 s compared to ~23 s; see Chapter 7, Tables 1 and 2). Nevertheless, these results support the model and suggest that to the extent to which extreme contraction frequencies mimic the influence of inter-subject variability due to different fibre-type profiles, the unique τ_p relationship for U→M, U→H and M→H transitions for a given subject might provide a useful way to quantify their fibre-type phenotype in a non-invasive manner if an association can be confirmed by direct measurement.

Summary

The pulmonary \dot{V}_{O_2} response to exercise provides key information about the rapidity with which oxidative phosphorylation in activated muscle fibres adapts during a transition to a higher work rate. However, it is important to recognise that considerable fibre-type-specific metabolic diversity can exist within a recruited pool and the pulmonary signal cannot discern this heterogeneity. In this thesis, evidence has been presented that supports the notion that fibre-recruitment heterogeneity contributing to the pulmonary signal can 'create' a \dot{V}_{O_2} slow component without delayed-onset changes in the O_2 cost of contractile activity. Furthermore, in circumstances where delayed-onset changes are present (e.g., when iEMG increases during high-intensity exercise), it is likely that the three-compartment pulmonary \dot{V}_{O_2} model necessarily oversimplifies a more multifaceted muscle \dot{V}_{O_2} response. Muscle fibre recruitment pattern also appears to be a critical determinant of changes in \dot{V}_{O_2} kinetics that have been reported when tissue oxygenation is altered. For example, findings contained herein are consistent with the notion that higher-order fibres are more susceptible to reduced tissue oxygenation; however, O_2 availability does not appear to rate modulate their oxidative response. Consequently, increasing O_2 availability does not accelerate \dot{V}_{O_2} kinetics in these fibres under normal circumstances. Instead, much like type I fibres, it is likely that the critical rate modulator in higher-order fibres is the time course of [PCr] degradation as dictated by the creatine kinase reaction or a related mechanism (e.g., the phosphorylation potential, free [ADP], P_i or any combination thereof).

In conclusion, the present thesis has established that muscle fibre recruitment exerts a strong influence on the pulmonary \dot{V}_{O_2} response during transitions to higher exercise work rates. Consequently, the influence of muscle fibre recruitment on \dot{V}_{O_2} kinetics is an

important factor to consider when using whole body O_2 uptake as a proxy for O_2 consumption in contracting skeletal muscle.

References

- Ament, W., Bonga, G.J.J., Hof, A.L. and Verkerke, G.J. (1993). EMG median power frequency in an exhausting exercise. *Journal of Electromyography and Kinesiology*, **3**, 214-220.
- Avogadro, P., Dolenc, A. and Belli, A. (2003). Changes in mechanical work during severe exhausting running. *European Journal of Applied Physiology*, **90**, 165-170.
- Bailey, S.J., Vanhatalo, A., Wilkerson, D.P., DiMenna, F.J. and Jones, A.M. (2010). Optimizing the “priming” effect: influence of prior exercise intensity and recovery duration on O₂ uptake kinetics and severe-intensity exercise tolerance. *Journal of Applied Physiology*, **107**, 1743-1756.
- Bangsbo, J., Gibala, M.J., Krstrup, P., Gonzalez-Alonso and Saltin, B. (2002). Enhanced pyruvate dehydrogenase activity does not affect muscle O₂ uptake at onset of intense exercise in humans. *American Journal of Physiology - Regulatory, Integrative and Comparative Physiology*, **282**, R273-R280.
- Bangsbo, J., Krstrup, P., Gonzalez-Alonso, J., Boushel, R. and Saltin, B. (2000). Muscle oxygen kinetics at onset of dynamic exercise in humans. *American Journal of Physiology - Regulatory, Integrative and Comparative Physiology*, **279**, R899-R906.
- Barstow, T.J., Jones, A.M., Nguyen, P.H. and Casaburi, R. (1996). Influence of muscle fiber type and pedal frequency on oxygen uptake kinetics of heavy exercise. *Journal of Applied Physiology*, **81**, 1642-1650.
- Barstow, T.J., Lamarra, N. and Whipp, B.J. (1990). Modulation of muscle and pulmonary O₂ uptakes by circulatory dynamics during exercise. *Journal of Applied Physiology*, **68**, 979-989.
- Barstow, T.J. and Mole, P.A. (1987). Simulation of pulmonary O₂ uptake during exercise transients in humans. *Journal of Applied Physiology*, **63**, 2253-2261.
- Barstow, T.J. and Mole, P.A. (1991). Linear and nonlinear characteristics of oxygen uptake kinetics during heavy exercise. *Journal of Applied Physiology*, **71**, 2099-2106.
- Beaver, W.L., Wasserman, K. and Whipp, B. (1986). A new method for detecting anaerobic threshold by gas exchange. *Journal of Applied Physiology*, **60**, 2020-2027.
- Behnke, B.J., Barstow, T.J., Kindig, C.A., McDonough, P., Musch, T.I. and Poole, D.C. (2002a). Dynamics of oxygen uptake following exercise onset in rat skeletal muscle. *Respiratory Physiology and Neurobiology*, **133**, 229-239

- Behnke, B.J., Kindig, C.A., Musch, T.I., Sexton, W.L. and Poole, D.C. (2002b). Effects of prior contractions on muscle microvascular oxygen pressure at onset of subsequent contractions. *Journal of Physiology*, **539**, 927-934.
- Behnke, B.J., McDonough, P., Padilla, D.J., Musch, T.I. and Poole, D.C. (2003). Oxygen exchange profile in muscles of contrasting fibre types. *Journal of Physiology*, **549**, 597-605.
- Berger, N.J.A., McNaughton, L.R., Keatley, S., Wilkerson, D.P. and Jones, A.M. (2006). Sodium bicarbonate ingestion alters the slow but not the fast phase of \dot{V}_{O_2} kinetics. *Medicine and Science in Sports and Exercise*, **38**, 1909-1917.
- Bessman, S.P. and Geiger, P.J. (1981). Transport of energy in muscle: the phosphorylcreatine shuttle. *Science*, **211**, 448-452.
- Borrani, F., Candau, R., Millet, G.Y., Perrey, S., Fuchslocher, J. and Rouillon, J.D. (2001). Is the $\dot{V}O_2$ slow component dependent on progressive recruitment of fast-twitch fibers in trained runners? *Journal of Applied Physiology*, **90**, 2212-2220.
- Bottinelli, R. and Reggiani, C. (2000). Human skeletal muscle fibres: molecular and functional diversity. *Progress in Biophysics and Molecular Biology*, **73**, 195-262.
- Bouckaert, J., Jones, A.M. and Koppo, K. (2004). Effect of glycogen depletion on the oxygen uptake slow component in humans. *International Journal of Sports Medicine*, **25**, 351-356.
- Bouissou, P., Estrade, P.Y., Goubel, F., Guezennec, C.Y. and Serrurier, B. (1989). Surface EMG power spectrum and intramuscular pH in human vastus lateralis muscle during dynamic exercise. *Journal of Applied Physiology*, **67**, 1245-1249.
- Brittain, C.J., Rossiter, H.B., Kowalchuk, J.M. and Whipp, B.J. (2001). Effect of prior metabolic rate on the kinetics of oxygen uptake during moderate-intensity exercise. *European Journal of Applied Physiology*, **86**, 125-134.
- Burnley, M., Doust, J.H., Ball, D. and Jones, A.M. (2002a). Effects of prior heavy exercise on heavy exercise $\dot{V}O_2$ kinetics are related to changes in muscle activity. *Journal of Applied Physiology*, **93**, 167-174.
- Burnley, M., Doust, J.H., Carter, H. and Jones, A.M. (2001). Effects of prior exercise and recovery duration on oxygen uptake kinetics during heavy exercise in humans. *Experimental Physiology*, **86**, 417-425.
- Burnley, M., Doust, J.H. and Jones, A.M. (2002b). Effects of prior heavy exercise, prior sprint exercise and passive warming on oxygen uptake kinetics during heavy exercise in humans. *European Journal of Applied Physiology*, **87**, 424-432.

- Burnley, M., Doust, J.H. and Jones, A.M. (2006). Time required for the restoration of normal heavy exercise $\dot{V}O_2$ kinetics following prior heavy exercise. *Journal of Applied Physiology*, **101**, 1320-1327.
- Burnley, M., Jones, A.M., Carter, H. and Doust, J.H. (2000). Effects of prior heavy exercise on phase II pulmonary oxygen uptake kinetics during heavy exercise. *Journal of Applied Physiology*, **89**, 1387-1396.
- Burnley, M., Koppo, K. and Jones, A.M. (2005). 'Priming exercise' and VO_2 kinetics. In *Oxygen Uptake Kinetics in Sport, Exercise and Medicine* (edited by A.M. Jones and D.C. Poole), pp 230-260. Routledge, London and New York.
- Cannon, D.T., Kolkhorst, F.W. and Cipriani, D.J. (2007). Electromyographic data do not support a progressive recruitment of muscle fibers during exercise exhibiting a VO_2 slow component. *Journal of Physiological Anthropology*, **26**, 541-546.
- Carter, H., Pringle, J.S.M., Boobis, L., Jones, A.M. and Doust, J.H. (2004). Muscle glycogen depletion alters oxygen uptake kinetics during heavy exercise. *Medicine and Science in Sports and Exercise*, **36**, 965-972.
- Casaburi, R., Barstow, T.J., Robinson, T. and Wasserman, K. (1989). Influence of work rate on ventilatory and gas exchange kinetics. *Journal of Applied Physiology*, **67**, 547-555.
- Casaburi, R., Whipp, B.J., Wasserman, K., Beaver, W.L. and Koyal, S.N. (1977). Ventilatory and gas exchange dynamics in response to sinusoidal work. *Journal of Applied Physiology: Respiratory Environmental Exercise Physiology*, **42**, 300-311.
- Cerretelli, P., Shindell, D., Pendergast, D.P., Di Prampero, P.E. and Rennie, D.W. (1977). Oxygen uptake transients at the onset and offset of arm and leg work. *Respiration Physiology* 30: 81-97.
- Chance, B. and Williams, C.M. (1955). Respiratory enzymes in oxidative phosphorylation. I. Kinetics of oxygen utilisation. *Journal of Biological Chemistry*, **217**, 383-393.
- Cleuziou, C., Perrey, S., Borrani, F., Lecoq, A.M., Courteix, D., Germain, P. and Obert, P. (2004). VO_2 and EMG activity kinetics during moderate and severe constant work rate exercise in trained cyclists. *Canadian Journal of Applied Physiology*, **29**, 758-772.
- Connett, R.J., Honig, C.R., Gayeski, T.E. and Brooks, G.A. (1990). Defining hypoxia: a systems view of VO_2 , glycolysis, energetics, and intracellular PO_2 . *Journal of Applied Physiology*, **68**, 833-842.

- Coyle, E.F., Sidossis, L.S., Horowitz, J.F. and Beltz, J.D. (1992). Cycling efficiency is related to the percentage of type I muscle fibers. *Medicine and Science in Sports and Exercise*, **24**, 782-788.
- Crow, M.T. and Kushmerick, M.J. (1982). Chemical energetics of slow- and fast-twitch muscles of the mouse. *Journal of General Physiology*, **79**, 147-166.
- Crow, M.T. and Kushmerick, M.J. (1983). Correlated reduction of velocity of shortening and the rate of energy utilization in mouse fast-twitch muscle during a continuous tetanus. *Journal of General Physiology*, **82**, 703-720.
- Cunningham, D.J.C. (1964). Claude Gordon Douglas. 1882-1963. *Biological Memoirs of Fellows of the Royal Society*, **10**, 51-74.
- Davies, C.T.M., Di Prampero, P.E. and Cerretelli, P. (1972). Kinetics of cardiac output and respiratory gas exchange during exercise and recovery. *Journal of Applied Physiology*, **32**, 618-625.
- Davy, H. (1800). Researches chemical and philosophical; chiefly concerning nitrous oxide, or dephlogisticated nitrous air, and its respiration, pp 429-438. J Johnson, London.
- DeLorey, D.S., Kowalchuk, J.M., Heenan, A.P., duManoir, G.R. and Paterson D.H. (2007) Prior exercise speeds pulmonary O₂ uptake kinetics by increases in both local muscle O₂ availability and O₂ utilization. *Journal of Applied Physiology*, **103**, 771-778.
- DeLorey, D.S., Kowalchuk, J.M. and Paterson, D.H. (2003). Relationship between pulmonary O₂ uptake kinetics and muscle deoxygenation during moderate-intensity exercise. *Journal of Applied Physiology*, **95**, 113-120.
- DeLorey, D.S., Kowalchuk, J.M. and Paterson, D.H. (2004). Effects of prior heavy-intensity exercise on pulmonary O₂ uptake and muscle deoxygenation kinetics in young and older adult humans. *Journal of Applied Physiology*, **97**, 998-1005.
- Denis, R. and Perrey, S. (2006) Influence of posture on pulmonary O₂ uptake kinetics, muscle deoxygenation and myoelectrical activity during heavy-intensity exercise. *Journal of Sports Science Medicine*, **5**, 254-265.
- Diamond, L.B., Casaburi, R., Wasserman, K. and Whipp, B.J. (1977). Kinetics of gas exchange and ventilation in transitions from rest to prior exercise. *Journal of Applied Physiology: Respiratory Environmental Exercise Physiology*, **43**, 704-708.
- Diederich, E.R., Behnke, B.J., McDonough, P., Kindig, C.A., Barstow, T.J., Poole, D.C. and Musch, T.I. Dynamics of microvascular oxygen partial pressure in contracting skeletal muscle of rats with chronic heart failure. *Cardiovascular Research*, **56**, 479-486.

- DiMenna, F.J. and Jones, A.M. (2009). “Linear” versus “Nonlinear” $\dot{V}O_2$ responses to exercise: reshaping traditional beliefs. *Journal of Exercise Science and Fitness*, **7**, 67-84.
- Di Prampero, P.E., Davies, C.T.M., Cerretelli, P. and Margaria, R. (1970). An analysis of O_2 debt contracted in submaximal exercise. *Journal of Applied Physiology*, **29**, 547-551.
- Di Prampero, P.E., Mahler, P.B., Giezendanner, D. and Cerretelli, P. (1989). Effects of priming exercise on VO_2 kinetics and O_2 deficit at the onset of stepping and cycling. *Journal of Applied Physiology*, **66**, 2023-2031.
- Dyke, C.K., Proctor, D.N., Dietz, N.M. and Joyner, M.J. (1995). Role of nitric oxide in exercise hyperaemia during prolonged rhythmic handgripping in humans, *Journal of Physiology*, **488**, 259-265.
- Elder, G.C., Bradbury, K. and Roberts, R. (1982). Variability of fibre type distributions within human muscles. *Journal of Applied Physiology*, **53**, 1473-1480.
- Endo, M., Kobayakawa, M., Kinugasa, R., Kuno, S., Akima, H., Rossiter, H.B., Miura, A. and Fukuba, Y. (2007). Thigh muscle activation distribution and pulmonary VO_2 kinetics during moderate, heavy, and very heavy intensity cycling exercise in humans. *American Journal of Physiology - Regulatory, Integrative and Comparative Physiology*, **293**, R812-R820.
- Endo, M., Okada, Y., Rossiter, H.B., Ooue, A., Miura, A., Koga, S. and Fukuba, Y. (2005). Kinetics of pulmonary VO_2 and femoral artery blood flow and their relationship during repeated bouts of heavy exercise. *European Journal of Applied Physiology*, **95**, 418-430.
- Engelen, M., Porszasz, J., Riley, M., Wasserman, K., Maehara, K. and Barstow, T.J. (1996). Effects of hypoxic hypoxia on O_2 uptake and heart rate kinetics during heavy exercise. *Journal of Applied Physiology*, **81**, 2500-2508.
- Essen, B., Jansson, E., Henriksson, J., Taylor, A.W. and Saltin, B. (1975). Metabolic characteristics of fibre types in human skeletal muscle. *Acta Physiologica Scandinavica*, **95**, 153-165.
- Ferguson, R.A., Ball, D., Krstrup, P., Aagaard, P., Kjær, M., Sargeant, A.J., Hellsten, Y. and Bangsbo, J. (2001). Muscle oxygen uptake and energy turnover during dynamic exercise at different contraction frequencies in humans. *Journal of Physiology*, **536**, 261-271.
- Ferreira, L.F., Lutjemeier, B.J., Townsend, D.K. and Barstow, T.J. (2006a). Effects of pedal frequency on estimated muscle microvascular O_2 extraction, *European Journal of Applied Physiology*, **96**, 558-563.

- Ferreira, L.F., McDonough, P., Behnke, B.J., Musch, T.I. and Poole, D.C. (2006b). Blood flow and O₂ extraction as a function of O₂ uptake in muscles composed of different fiber types. *Respiratory Physiology and Neurobiology*, **153**, 237-249.
- Francescato, M., Girardis, M. and Di Prampero, P.E. Oxygen cost of internal work during cycling. *European Journal of Applied Physiology*, **72**, 51-57.
- Fujihara, Y., Hildebrandt, J. and Hildebrandt, J.R. (1973a). Cardiorespiratory transients in exercising man II. Tests of superposition. *Journal of Applied Physiology*, **35**, 68-76.
- Fujihara, Y., Hildebrandt, J.R. and Hildebrandt, J. (1973b). Cardiorespiratory transients in exercising man I. Tests of superposition. *Journal of Applied Physiology*, **35**, 58-67.
- Fukuba, Y., Hayashi, N., Koga, S. and Yoshida, T. (2002). $\dot{V}O_2$ kinetics in heavy exercise is not altered by prior exercise with a different muscle group. *Journal of Applied Physiology*, **92**, 2467-2474.
- Gaesser, G.A. and Brooks, G.A. (1975). Muscular efficiency during steady-rate exercise: effects of speed and work rate. *Journal of Applied Physiology*, **38**, 1132-1139.
- Gaesser, G.A. and Brooks, G.A. (1984). Metabolic bases of excess post-exercise oxygen consumption: a review. *Medicine and Science in Sports and Exercise*, **16**, 29-43.
- Gaesser, G.A. and Poole, D.C. (1996). The slow component of oxygen uptake kinetics in humans. *Exercise and Sport Sciences Reviews*, **24**, 35-70.
- Gaesser, G.A., Ward, S.A., Baum, V.C. and Whipp, B.J. (1994). Effects of infused epinephrine on slow phase of oxygen uptake kinetics during heavy exercise in humans. *Journal of Applied Physiology*, **77**, 2413-2419.
- Garland, S.W., Wang, W. and Ward, S.A. (2006). Indices of electromyographic activity and the "slow" component of oxygen uptake kinetics during high-intensity knee-extension exercise in humans. *European Journal of Applied Physiology*, **97**, 413-423.
- Gerbino, A., Ward, S.A. and Whipp, B.J. (1996). Effects of prior exercise on pulmonary gas-exchange kinetics during high-intensity exercise in humans. *Journal of Applied Physiology*, **80**, 99-107.
- Gerdle, B., Henriksson-Larsen, K., Lorentzon, R. and Wretling, M.L. (1991). Dependence of the mean power frequency of the electromyogram on muscle force and fibre type. *Acta Physiologica Scandinavica*, **142**, 457-465.

- Gollnick, P.D., Armstrong, R.B., Saltin, B., Saubert, C.W.T., Sembrowich, W.L. and Shepherd, R.E. (1973). Effect of training on enzyme activity and fibre composition of human skeletal muscle. *Journal of Applied Physiology*, **34**, 107-111.
- Gollnick, P.D., Armstrong, R.B., Saubert, C.W.T., Piehl, K. and Saltin, B. (1972). Enzyme activity and fibre composition in skeletal muscle of untrained and trained men. *Journal of Applied Physiology*, **33**, 312-319.
- Grassi, B. (2005). Limitation of skeletal muscle \dot{V}_{O_2} kinetics by inertia of cellular respiration. In *Oxygen Uptake Kinetics in Sport, Exercise and Medicine* (edited by A.M. Jones and D.C. Poole), pp 212-229. Routledge, London and New York.
- Grassi, B., Gladden, L.B., Samaja, M., Stary, C.M. and Hogan, M.C. (1998). Faster adjustment of O_2 delivery does not affect \dot{V}_{O_2} on-kinetics in isolated in situ canine muscle. *Journal of Applied Physiology*, **85**, 1404-1412.
- Grassi, B., Hogan, M.C., Greenhaff, P.L., Hamann, J.J., Kelley, K.M., Aschenbach, W.G., Constantin-Teodosiu, D. and Gladden, L.B. (2002). Oxygen uptake on-kinetics in dog gastrocnemius in situ following activation of pyruvate dehydrogenase by dichloroacetate. *Journal of Physiology*, **538**, 195-207.
- Grassi, B., Pogliaghi, S., Rampichini, S., Quaresima, V., Ferrari, M., Marconi, C. and Cerretelli, P. (2003). Muscle oxygenation and gas exchange kinetics during cycling exercise on-transition in humans. *Journal of Applied Physiology*, **95**, 149-158.
- Grassi, B., Poole, D.C., Richardson, R.S., Knight, D.R., Erickson, B.K. and Wagner, P.D. (1996). Muscle O_2 uptake kinetics in humans: implications for metabolic control. *Journal of Applied Physiology*, **80**, 988-998.
- Greenhaff, P.L., Campbell-O'Sullivan, S.P., Constantin-Teodosiu, D., Poucher, S.M., Roberts, P.A. and Timmons, J.A. (2002). An acetyl group deficit limits mitochondrial ATP production at the onset of exercise. *Biochemical Society Transactions*, **30**, 275-280.
- Gurd, B.J., Peters, S.J., Heigenhauser, G.J.F., LeBlanc, P.J., Doherty, T.J., Paterson, D.H. and Kowalchuk, J.M. (2009). Prior heavy exercise elevates pyruvate dehydrogenase activity and muscle oxygenation and speeds O_2 uptake kinetics during moderate exercise in older adults. *American Journal of Physiology – Regulatory, Integrative and Comparative Physiology*, **297**, R877-R884.
- Hansford, R. G. (1994) Role of calcium in respiratory control. *Medicine and Science in Sports and Exercise*, **26**, 44-51.
- Harper, A.J., Ferreira, L.F., Lutjemeier, B.J., Townsend, D.K. and Barstow, T.J. (2006). Human femoral artery and estimated muscle capillary blood flow kinetics following the onset of exercise. *Experimental Physiology*, **91**, 661-671.

- Henneman, E., Somjen, G. and Carpenter, D.O. (1965). Excitability and inhibitability of motoneurons of different sizes. *Journal of Neurophysiology*, **28**, 599-620.
- Henry, F.M. (1951). Aerobic Oxygen Consumption and Alactic Debt in Muscular Work. *Journal of Applied Physiology*, **3**, 427-438.
- Henry, F.M. and DeMoor, J.C. (1956). Lactic and Alactic Oxygen Consumption in Moderate Exercise of Graded Intensity. *Journal of Applied Physiology*, **8**, 608-614.
- Hill, A.V., Long, C.N.H. and Lupton, H. (1924). Muscular Exercise, Lactic Acid, and the Supply and Utilisation of Oxygen - Parts IV-VIII. *Proceedings of the Royal Society of London Series B*, **97**, 84-176.
- Hill, D.W., Poole, D.C. and Smith, J.C. (2002). The relationship between power and the time to achieve $\dot{V}O_2$ max. *Medicine and Science in Sports and Exercise*, **34**, 709-714.
- Hogan, M.C. (2001) Fall in intracellular PO_2 at the onset of contractions in *Xenopus* single skeletal muscle fibers. *Journal of Applied Physiology*, **90**, 1871-1876.
- Hughson, R.L. (1984). Alterations in the oxygen deficit-oxygen debt relationships with beta adrenergic receptor blockade in man. *Journal of Physiology*, **349**, 375-387.
- Hughson, R.L. (2005). Regulation of $\dot{V}O_2$ on-kinetics by O_2 delivery. In *Oxygen Uptake Kinetics in Sport, Exercise and Medicine* (edited by A.M. Jones and D.C. Poole), pp 185-211. Routledge, London and New York.
- Hughson, R.L. and Morrissey, M. (1982). Delayed kinetics of respiratory gas exchange in the transition from prior exercise. *Journal of Applied Physiology: Respiratory Environmental Exercise Physiology*, **52**, 921-929.
- Hughson, R.L. and Morrissey, M. (1983). Delayed kinetics of $\dot{V}O_2$ in the transition from prior exercise. Evidence for O_2 transport limitation of $\dot{V}O_2$: a review. *International Journal of Sports Medicine*, **4**, 31-39.
- Jeneson, J.A.L., Westerhoff, H.V., Brown, T.R., van Echteld, C.J.A. and Berger, R. (1995) Quasi-linear relationship between Gibbs free energy of ATP hydrolysis and power output in human forearm muscle. *American Journal of Physiology - Cell Physiology*, **268**, C1474-C1484.
- Jones, A.M., Berger, N.J.A., Wilkerson, D.P. and Roberts, C.L. (2006). Effects of "priming" exercise on pulmonary O_2 uptake and muscle deoxygenation kinetics during heavy-intensity cycle exercise in the supine and upright positions. *Journal of Applied Physiology*, **101**, 1432-1441.
- Jones, A.M., Carter, H., Pringle, J.S. and Campbell, I.T. (2002). Effect of creatine supplementation on oxygen uptake kinetics during submaximal cycle exercise. *Journal of Applied Physiology*, **92**, 2571-2577.

- Jones, A.M., Koppo, K., Wilkerson, D.P. and Campbell, I.T. (2003). Inhibition of nitric oxide synthase by L-NAME speeds $\dot{V}O_2$ kinetics in the transition to moderate intensity exercise in man. *Journal of Physiology*, **552**, 265-272.
- Jones, A.M., Koppo, K., Wilkerson, D.P., Wilmschurst, S. and Campbell, I.T. (2004a). Dichloroacetate does not speed phase-II pulmonary $\dot{V}O_2$ kinetics following the onset of heavy intensity cycle exercise. *Pflugers Archives*, **447**, 867-874.
- Jones, A.M. and Poole, D.C. (2005). Introduction to oxygen uptake kinetics and historical development of the discipline. In *Oxygen Uptake Kinetics in Sport, Exercise and Medicine* (edited by A.M. Jones and D.C. Poole), pp 3-35. Routledge, London and New York.
- Jones, A.M., Pringle, J.S.M. and Carter, H. (2005). Influence of muscle fibre type and motor unit recruitment on $\dot{V}O_2$ kinetics. In *Oxygen Uptake Kinetics in Sport, Exercise and Medicine* (edited by A.M. Jones and D.C. Poole), pp 261-293. Routledge, London and New York.
- Jones, A.M., Wilkerson, D.P. and Fulford, J. (2008). Muscle [phosphocreatine] dynamics following the onset of exercise in humans: the influence of baseline work-rate. *Journal of Physiology*, **586**, 889-898.
- Jones, A.M., Wilkerson, D.P. and Fulford, J. (2009). Influence of dietary creatine supplementation on muscle phosphocreatine kinetics during knee-extensor exercise in humans. *American Journal of Physiology – Regulatory, Integrative and Comparative Physiology*, **296**, R1078-R1087.
- Jones, A.M., Wilkerson, D.P., Wilmschurst, S. and Campbell, I.T. (2004b). Influence of L-NAME on pulmonary O_2 uptake kinetics during heavy-intensity cycle exercise. *Journal of Applied Physiology*, **96**, 1033-1038.
- Kindig, C.A., Howlett, R.A., Stary, C.M., Walsh, B. and Hogan, M.C. (2005). Effects of acute creatine kinase inhibition on metabolism and tension development in isolated single myocytes. *Journal of Applied Physiology*, **98**, 541-549.
- Kindig, C.A., Kelley, K.M., Howlett, R.A., Stary, C.M. and Hogan, M.C. (2003). Assessment of O_2 uptake dynamics in isolated single skeletal myocytes. *Journal of Applied Physiology*, **94**, 353-357.
- Kindig, C.A., Richardson, T.E. and Poole, D.C. (2002). Skeletal muscle capillary hemodynamics from rest to contractions: implications for oxygen transfer. *Journal of Applied Physiology*, **92**, 2513-2520.
- Knight, D.R., Schaffartzik, W., Poole, D.C., Hogan, M.C., Bebout, D.E. and Wagner, P.D. (1993). Effects of hyperoxia on maximal leg O_2 supply and utilization in man. *Journal of Applied Physiology*, **75**, 2586-2594.

- Koga, S., Poole, D.C., Ferreira, L.F., Whipp, B.J., Kondo, N., Saitoh, T, Ohmae, E. and Barstow, T.J. (2008). Spatial heterogeneity of quadriceps muscle deoxygenation kinetics during cycle exercise. *Journal of Applied Physiology*, **103**, 2049-2056.
- Koga, S., Shiojiri, T., Kondo, N. and Barstow, T.J. (1997). Effects of increased muscle temperature on oxygen uptake kinetics during exercise. *Journal of Applied Physiology*, **83**, 1333-1338.
- Koga, S., Shiojiri, T., Shibasaki, M., Kondo, N., Fukuba, Y. and Barstow, T.J. (1999). Kinetics of oxygen uptake during supine and heavy exercise. *Journal of Applied Physiology*, **87**, 253-260.
- Koppo, K. and Bouckaert, J. (2000). In humans the oxygen uptake slow component is reduced by prior exercise of high as well as low intensity. *European Journal of Applied Physiology*, **83**, 559-565.
- Koppo, K. and Bouckaert, J. (2001). The effect of prior high-intensity cycling exercise on the \dot{V}_{O_2} kinetics during high-intensity cycling exercise is situated at the additional slow component. *International Journal of Sports Medicine*, **22**, 21-26.
- Koppo, K. and Bouckaert, J. (2002). The decrease in the \dot{V}_{O_2} slow component induced by prior exercise does not affect the time to exhaustion. *International Journal of Sports Medicine*, **23**, 262-267.
- Koppo, K. and Bouckaert, J. (2005). Prior arm exercise speeds the \dot{V}_{O_2} kinetics during arm exercise above the heart level. *Medicine and Science in Sports and Exercise*, **37**, 613-619.
- Koppo, K., Bouckaert, J. and Jones, A.M. (2004). Effect of training status and exercise intensity on phase II \dot{V}_{O_2} kinetics. *Medicine and Science in Sports and Exercise*, **36**, 225-232.
- Koppo, K., Jones, A.M., Vanden Bossche, L. and Bouckaert, J. (2002). Effect of prior exercise on \dot{V}_{O_2} slow component is not related to muscle temperature. *Medicine and Science in Sports and Exercise*, **34**, 1600-1604.
- Kranz, H., Williams, A.M., Cassell, J., Caddy, D.J. and Silberstein, R.B. (1983). Factors determining the frequency content of the electromyogram. *Journal of Applied Physiology*, **55**, 392-399.
- Krogh, A. and Lindhard, J. (1913). The regulation of respiration and circulation during the initial stages of muscular work. *Journal of Physiology*, **47**, 112-136.
- Krustrup, P., Jones, A.M., Wilkerson, D.P., Calbet, J. and Bangsbo, J. (2009). Muscular and pulmonary O_2 -uptake kinetics during moderate and high-intensity sub-maximal knee extensor exercise in humans. *Journal of Physiology*, **587**, 1843-1856.

- Krustrup, P., Secher, N.H., Relu, M.U., Hellsten, Y., Soderlund, K. and Bangsbo, J. (2008). Neuromuscular blockade of slow twitch muscle fibres elevates muscle oxygen uptake and energy turnover during submaximal exercise in humans. *Journal of Physiology*, **586**, 6037-6048.
- Krustrup, P., Soderlund, K., Mohr, M. and Bangsbo, J. (2004a). Slow-twitch fiber glycogen depletion elevates moderate-exercise fast-twitch fiber activity and O₂ uptake. *Medicine and Science in Sports and Exercise*, **36**, 973-982.
- Krustrup, P., Soderlund, K., Mohr, M. and Bangsbo, J. (2004b). The slow component of oxygen uptake during intense sub-maximal exercise in man is associated with additional fibre recruitment. *Pflugers Archives*, **447**, 855-866.
- Kupa, E.J., Roy, S.H., Kandarian, S.C. and DeLuca, C.J. (1995). Effects of muscle fibre type and size on EMG median power frequency and conduction velocity. *Journal of Applied Physiology*, **79**, 23-32.
- Lamarra, N., Whipp, B.J., Ward, S.A. and Wasserman, K. (1987). Effect of interbreath fluctuations on characterizing exercise gas exchange kinetics. *Journal of Applied Physiology*, **62**, 2003-2012.
- Lavoisier, A. (1789). *Traité élémentaire de chimie*, 2 vols. Chez Cuchet, Paris. Translated from French by: Kerr, R. (1790). *Elements of chemistry*, 4th edition. William Creech, Edinburgh.
- Layec, G., Bringard, A., Le Fur, Y., Vilmen, C., Micallef, J-P., Perrey, S., Cozzone, P.J. and Bendahan, D. (2009). Effects of a prior high-intensity knee-extension exercise on muscle recruitment and energy cost: a combined local and global investigation in humans. *Experimental Physiology*, **94**, 704-719.
- Leyk, D., Essfeld, D., Hoffmann, U., Wunderlich, H.G., Baum, K. and Stegemann, J. (1994). Postural effect on cardiac output, oxygen uptake and lactate during cycle exercise of varying intensity. *European Journal of Applied Physiology*, **68**, 30-35.
- Linnarsson, D. (1974). Dynamics of pulmonary gas exchange and heart rate changes at start and end of exercise. *Acta Physiologica Scandinavica*, **415**, 1-68.
- Lucia, A., Hoyos, J. and Chicharro, J.L. (2000). The slow component of \dot{V}_{O_2} in professional cyclists. *British Journal of Sports Medicine*, **34**, 367-374.
- MacDonald, M., Pedersen, P.K. and Hughson, R.L. (1997). Acceleration of \dot{V}_{O_2} kinetics in heavy submaximal exercise by hyperoxia and prior high-intensity exercise. *Journal of Applied Physiology*, **83**, 1318-25.
- MacDonald, M.J., Shoemaker, J.K., Tschakovsky, M.E. and Hughson, R.L. (1998). Alveolar oxygen uptake and femoral artery blood flow dynamics in upright and supine leg exercise in humans. *Journal of Applied Physiology*, **85**, 1622-1628.

- MacIntosh, B.R., Neptune, R.R. and Horton, J.F. (2000). Cadence, power and muscle activation in cycle ergometry. *Medicine and Science in Sports and Exercise*, **32**, 1281-1287.
- MacPhee, S.L., Shoemaker, J.K., Paterson, D.H. and Kowalchuk, J.M. (2005). Kinetics of O₂ uptake, leg blood flow, and muscle deoxygenation are slowed in the upper compared with lower region of the moderate-intensity exercise domain. *Journal of Applied Physiology*, **99**, 1822-1834.
- Mahler, M. (1985). First order kinetics of muscle oxygen consumption and equivalent proportionality between QO₂ and phosphorylcreatine level. Implications for the control of respiration. *Journal of General Physiology*, **86**, 135-165.
- Margaria, R., Mangili, F., Cuttica, F. and Cerretelli, P. (1965). The kinetics of oxygen consumption at the onset of muscular exercise in man. *Ergonomics*, **8**, 49-54.
- McDonough, P., Behnke, B.J., Padilla, D.J., Musch, T.I. and Poole, D.C. (2005). Control of microvascular oxygen pressures in muscles comprised of different fibre types. *Journal of Physiology*, **563**, 903-913.
- Meyer, R.A. (1988). A linear model of muscle respiration explains monoexponential phosphocreatine changes. *American Journal of Physiology - Cell Physiology*, **254**, C548-C553.
- Meyer, R.A. (1989). Linear dependence of muscle phosphocreatine kinetics on total creatine contents. *American Journal of Physiology - Cell Physiology*, **257**, C1149-C1157.
- Migita, T. and Hirakoba, K. (2006). Effect of different pedal rates on oxygen uptake slow component during constant-load cycling exercise. *Journal of Sports Medicine and Physical Fitness*, **46**, 189-196.
- Moncada, S., Palmer, R.M. and Higgs, E.A. (1991). Nitric oxide: physiology, pathophysiology, and pharmacology. *Pharmacological Review*, **43**, 109-142.
- Monod, H. and Scherrer, J. (1965). The work capacity of a synergic muscle group. *Ergonomics*, **8**, 329-338.
- Moritani, T., Nagata, A., de Vries, H.A. and Muro, M. (1981). Critical power as a measure of critical work capacity and anaerobic threshold. *Ergonomics*, **24**, 339-350.
- Moritani, T., Sherman, W.M., Shibata, M., Matsumoto, T. and Shinohara, M. (1992). Oxygen availability and motor unit activity in humans. *European Journal of Applied Physiology*, **64**, 552-556.
- Morton, R.H. (1987). Delayed or accelerated oxygen uptake kinetics in the transition from prior exercise. *Journal of Applied Physiology*, **62**, 844-846.

- Nemeth, P.M. and Lowry, O.H. (1984). Myoglobin levels in individual human skeletal muscle fibers of different types. *Journal of Histochemistry and Cytochemistry*, **32**, 1211-1216.
- Osborne, M.A. and Schneider, D.A. (2006). Muscle glycogen reduction in man: relationship between surface EMG activity and oxygen uptake kinetics during heavy exercise. *Experimental Physiology*, **91**, 179-189.
- Paganini, A.T., Foley, J.M. and Meyer, R.A. (1997). Linear dependence of muscle phosphocreatine kinetics on oxidative capacity. *American Journal of Physiology – Cell Physiology*, **272**, C501–C510.
- Paterson, D.H. and Whipp, B.J. (1991). Asymmetries of oxygen uptake transients at the on- and offset of heavy exercise in humans. *Journal of Physiology*, **443**, 575-586.
- Perrey, S., Betik, A., Candau, R., Rouillon, J.D. and Hughson, R.L. (2001). Comparison of oxygen uptake kinetics during concentric and eccentric cycle exercise. *Journal of Applied Physiology*, **91**, 2135-2142.
- Petrofsky, J.S. and Lind, A.R. (1980). The influence of temperature on the amplitude and frequency components of the EMG during brief and sustained isometric contractions. *European Journal of Applied Physiology*, **44**, 189-200.
- Phillips, S.M., Green, H.J., MacDonald, M.J. and Hughson, R.L. (1995) Progressive effect of endurance training on \dot{V}_{O_2} kinetics at the onset of submaximal exercise. *Journal of Applied Physiology*, **79**, 1914–1920.
- Poole, D.C., Barstow, T.J., McDonough, P. and Jones, A.M. (2008). Control of oxygen uptake during exercise. *Medicine and Science in Sports and Exercise*, **40**, 462-474.
- Poole, D.C., Ferreira, L.F., Barstow, T.J. and Jones, A.M. (2007). The final frontier: Oxygen flux into muscle at exercise onset. *Exercise and Sport Sciences Reviews*, **35**, 166-173.
- Poole, D.C., Gladden, L.B., Kurdak, S. and Hogan, M.C. (1994). L-(+)-lactate infusion into working dog gastrocnemius: no evidence lactate per se mediates \dot{V}_{O_2} slow component. *Journal of Applied Physiology*, **76**, 787-792.
- Poole, D.C. and Jones, A.M. (2005). Towards an understanding of the mechanistic bases of \dot{V}_{O_2} kinetics. In *Oxygen Uptake Kinetics in Sport, Exercise and Medicine* (edited by A.M. Jones and D.C. Poole), pp294-328. Routledge, London and New York.
- Poole, D.C., Kindig, C.A. and Behnke, B.J. (2005). \dot{V}_{O_2} kinetics in different disease states. In *Oxygen Uptake Kinetics in Sport, Exercise and Medicine* (edited by A.M. Jones and D.C. Poole), pp 353-372. Routledge, London and New York.

- Poole, D.C., Schaffartzik, W., Knight, D.R., Derion, T., Kennedy, B., Guy, H.J., Prediletto, R. and Wagner, P.D. (1991). Contribution of exercising legs to the slow component of oxygen uptake kinetics in humans. *Journal of Applied Physiology*, **71**, 1245-1260.
- Poole, D.C., Ward, S.A., Gardner, G.W. and Whipp, B.J. (1988). Metabolic and respiratory profile of the upper limit for prolonged exercise in man. *Ergonomics*, **31**, 1265-1279.
- Priestley, J. (1775). Experiments and observations on different kinds of air (Vol 1). J Johnson, London.
- Pringle, J.S.M., Doust, J.H., Carter, H., Tolfrey, K., Campbell, I.T. and Jones, A.M. (2003a). Oxygen uptake kinetics during constant-load 'submaximal' exercise in humans: the influence of muscle fibre type and capillarisation. *European Journal of Applied Physiology*, **89**, 289-300.
- Pringle, J.S.M., Doust, J.H., Carter, H., Tolfrey, K. and Jones, A.M. (2003b). Effect of pedal rate on primary and slow-component oxygen uptake responses during heavy-cycle exercise. *Journal of Applied Physiology*, **94**, 1501-1507.
- Pringle, J.S.M. and Jones, A.M. (2002). Maximal lactate steady state, critical power and EMG during cycling. *European Journal of Applied Physiology*, **88**, 214-226.
- Rådegran, G. and Saltin, B. (1999). Nitric oxide in the regulation of vasomotor tone in human skeletal muscle. *American Journal of Physiology – Heart and Circulatory Physiology*, **276**, H1951–H1960.
- Reggiani, C., Potma, E.J., Bottinelli, R., Canepari, M., Pelligrino, M.A. and Stienen, G.J. (1997). Chemo-mechanical energy transduction in relation to myosin isoform composition in skeletal muscle fibres of the rat. *Journal of Physiology*, **502**, 449-460.
- Rossiter, H.B., Howe, F.A. and Ward, S.A. (2005). Intramuscular phosphate and pulmonary \dot{V}_{O_2} kinetics during exercise: Implications for control of skeletal muscle oxygen consumption. In *Oxygen Uptake Kinetics in Sport, Exercise and Medicine* (edited by A.M. Jones and D.C. Poole), pp 154-184. Routledge, London and New York.
- Rossiter, H.B., Ward, S.A., Doyle, V.L., Howe, F.A., Griffiths, J.R. and Whipp, B.J. (1999). Inferences from pulmonary O_2 uptake with respect to intramuscular [PCr] kinetics during moderate exercise in humans. *Journal of Physiology*, **518**, 921-932.
- Rossiter, H.B., Ward, S.A., Howe, F.A., Kowalchuk, J.M., Griffiths, J.R. and Whipp, B.J. (2002a). Dynamics of intramuscular ^{31}P -MRS Pi peak splitting and the slow component of PCr and O_2 uptake during exercise. *Journal of Applied Physiology*, **93**, 2059-2069.

- Rossiter, H.B., Ward, S.A., Howe, F.A., Wood, D.M., Kowalchuk, J.M., Griffiths, J.R. and Whipp, B.J. (2003). Effects of dichloroacetate on \dot{V}_{O_2} and intramuscular 31P metabolite kinetics during high-intensity exercise in humans. *Journal of Applied Physiology*, **95**, 1105-1115.
- Rossiter, H.B., Ward, S.A., Kowalchuk, J.M., Howe, F.A., Griffiths, J.R. and Whipp, B.J. (2001). Effects of prior exercise on oxygen uptake and phosphocreatine kinetics during high-intensity knee-extension exercise in humans. *Journal of Physiology*, **537**, 291-303.
- Rossiter, H.B., Ward, S.A., Kowalchuk, J.M., Howe, F.A., Griffiths, J.R. and Whipp, B.J. (2002b). Dynamic asymmetry of phosphocreatine concentration and O_2 uptake between the on- and off-transients of moderate- and high-intensity exercise in humans. *Journal of Physiology*, **541**, 991-1002.
- Roston, W.L., Whipp, B.J., Davis, J.A., Cunningham, D.A., Effros, R.M. and Wasserman, K. (1987). Oxygen uptake kinetics and lactate concentration during exercise in humans. *The American Review of Respiratory Disease*, **135**, 1080-1084.
- Rowell, L.B. and O'Leary, D.S. (1990). Reflex control of the circulation during exercise: chemoreflexes and mechanoreflexes. *Journal of Applied Physiology*, **69**, 407-418.
- Sabapathy, S., Schneider, D.A. and Morris, N.R. (2005). The \dot{V}_{O_2} slow component: Relationship between plasma ammonia and EMG activity. *Medicine and Science in Sports and Exercise*, **37**, 1502-1509.
- Saks, V.A., Kaambre, T., Sikk, P., Eimre, M., Orlova, E., Paju, K., Piirsoo, A., Appaix, F., Kay, L., Regitz-Zagrosek, V., Fleck, E. and Seppet, E. (2001). Intramuscular energetic units in red muscle cells. *Biochemistry Journal*, **356**, 643-657.
- Sargeant, A.J. (1999). Neuromuscular determinants of human performance. In *Physiological Determinants of Exercise Tolerance in Humans* (edited by B.J. Whipp and A.J. Sargeant), pp 13-28. The Physiological Society, Portland Press, London.
- Sargeant, A.J. (2007). Structural and functional determinants of human muscle power. *Experimental Physiology*, **92**, 323-331.
- Sargeant, A.J. and de Haan, A. (2006). Human muscle fatigue: the significance of muscle fibre type variability studied using a micro-dissection approach. *Journal of Physiology (Supplement 10)*, **57**, 5-16.
- Saunders, M.J., Evans, E.M., Arngrimsson, S.A., Allison, J.D. and Cureton, K.J. (2003). Endurance training reduces end-exercise \dot{V}_{O_2} and muscle use during submaximal cycling. *Medicine and Science in Sports and Exercise*, **35**, 257-262.

- Saunders, M.J., Evans, E.M., Arngrimsson, S.A., Allison, J.D., Warren, G.L. and Cureton, K.J. (2000). Muscle activation and the slow component rise in oxygen uptake during cycling. *Medicine and Science in Sports and Exercise*, **32**, 2040-2045.
- Scheele, C.W. (1912). The discovery of oxygen. The Alembic Club, Edinburgh.
- Scheuermann, B.W., Hoelting, B.D., Noble, M.L. and Barstow, T.J. (2001). The slow component of O₂ uptake is not accompanied by changes in muscle EMG during repeated bouts of heavy exercise in humans. *Journal of Physiology*, **531**, 245-256.
- Seki, K. and Narusawa, M. (1996). Firing rate modulation of human motor units in different muscles during isometric contraction with various forces. *Brain Research*, **719**, 1-7.
- Shen, W., Xu, X., Ochoa, M., Zhao, G., Wolin, M.S. and Hintze, T.H. (1994). Role of nitric oxide in the regulation of oxygen consumption in conscious dogs. *Circulation Research*, **75**, 1086-1095.
- Shinohara, M. and Moritani, T. (1992). Increase in neuromuscular activity and oxygen uptake during heavy exercise. *Annals of Physiological Anthropology*, **11**, 257-262.
- Smith, C.G. and Jones, A.M. (2001). The relationship between critical velocity, maximal lactate steady-state velocity and lactate turnpoint velocity in runners. *European Journal of Applied Physiology*, **85**, 19-26.
- Söderlund, K. and Hultman, E. (1991) ATP and phosphocreatine changes in single human muscle fibers after intense electrical stimulation. *American Journal of Physiology – Endocrinology and Metabolism*, **261**, E737-E741.
- Sprigge, J.S. (2002). Sir Humphry Davy; his researches in respiratory physiology and his debt to Antoine Lavoisier. *Anaesthesia*, **57**, 357-364.
- Staron, R.S. (1997). Human skeletal muscle fibre types: delineation, development, and distribution. *Canadian Journal of Applied Physiology*, **22**, 307-327.
- Stirling, J.R. and Zakyntinaki, M. (2009). Counterpoint: The kinetics of oxygen uptake during muscular exercise do not manifest time-delayed phases. *Journal of Applied Physiology*, **107**, 1665-1667.
- Taylor, D.J., Bore, P.J., Styles, P., Gadian, D.G. and Radda, G.K. (1983). Bioenergetics of intact human muscle. A ³¹P nuclear magnetic resonance study. *Molecular Biology and Medicine*, **1**, 77-94.

- Timmons, J.A., Gustafsson, T., Sundberg, C.J., Jansson, E. and Greenhaff, P.L. (1998). Muscle acetyl group availability is a major determinant of oxygen deficit in humans during submaximal exercise. *American Journal of Physiology – Endocrinology and Metabolism*, **274**, E377-E380.
- Tordi, N., Perrey, S., Harvey, A. and Hughson, R.L. (2003). Oxygen uptake kinetics during two bouts of heavy cycling separated by fatiguing sprint exercise in humans. *Journal of Applied Physiology*, **94**, 533-541.
- Tschakovsky, M.E. and Hughson, R.L. (1999). Interaction of factors determining oxygen uptake at the onset of exercise. *Journal of Applied Physiology*, **86**, 1101-1113.
- Vanhatalo, A., Doust, J.H. and Burnley, M. (2007). Determination of critical power using a 3-min all-out cycling test. *Medicine & Science in Sports & Exercise*, **39**, 548-555.
- Vanhatalo, A., Doust, J.H. & Burnley, M. (2008). A 3-min all-out cycling test is sensitive to a change in critical power. *Medicine & Science in Sports & Exercise*, **40**, 1693-1699.
- Vercruyssen, F., Missenard, O. and Brisswalter, J. (2009). Relationship between oxygen uptake slow component and surface EMG during heavy exercise in humans: Influence of pedal rate. *Journal of Electromyography and Kinesiology*, **19**, 676-684.
- Versteeg, P.G.A., Sampurno, S.B., Sipkema, P. and Elzinga, G. (1981). Control of cardiac output in exercising dogs using different types of workload. *Cardiovascular Research*, **15**, 151-158.
- Vøllestad, N.K. and Blom, P.C. (1985). Effect of varying exercise intensity on glycogen depletion in human muscle fibres. *Acta Physiologica Scandinavica*, **125**, 395-405.
- Vøllestad, N.K., Vaage, O. and Hermansen, L. (1984). Muscle glycogen depletion patterns in type I and subgroups of type II fibres during prolonged severe exercise in man. *Acta Physiologica Scandinavica*, **122**, 433-441.
- Walsh, B., Tonkonogi, M., Soderlund, K., Hultman, E., Saks, V. and Sahlin, K. (2001). The role of phosphoryl creatine and creatine in the regulation of mitochondrial respiration in human skeletal muscle. *Journal of Physiology*, **537**, 971-978.
- Wasserman, K., Van Kessel, A.L. and Burton, G.G. (1967). Interaction of physiological mechanisms during exercise. *Journal of Applied Physiology*, **22**, 71-85.
- Welch, H.G., Bonde-Petersen, F., Graham, T., Klausen, K. and Secher, N. (1977). Effects of hyperoxia on leg blood flow and metabolism during exercise. *Journal of Applied Physiology*, **42**, 385-390.

- Wendt, I.R. and Gibbs, C.L. (1973). Energy production of rat extensor digitorum longus muscle. *American Journal of Physiology*, **224**, 1081-1086.
- Whipp, B.J. (1971). Rate constant for the kinetics of oxygen uptake during light exercise. *Journal of Applied Physiology*, **30**, 261-263.
- Whipp, B.J. (1994). The slow component of O₂ uptake kinetics during heavy exercise. *Medicine and Science in Sports and Exercise*, **26**, 1319-1326.
- Whipp, B.J. (2009). Point: The kinetics of oxygen uptake during muscular exercise do manifest time-delayed phases. *Journal of Applied Physiology*, **107**, 1663-1665.
- Whipp, B.J., Davis, J.A., Torres, F. and Wasserman, K. (1981). A test to determine parameters of aerobic function during exercise. *J Appl Physiol*, **50**, 217-221.
- Whipp, B.J. and Mahler, M. (1980). Dynamics of gas exchange during exercise. In *Pulmonary Gas Exchange, Vol. II.* (edited by J.B. West), pp 33-96. Academic Press, New York.
- Whipp, B.J. and Rossiter, H.B. (2005). The kinetics of oxygen uptake: Physiological inferences from the parameters. In *Oxygen Uptake Kinetics in Sport, Exercise and Medicine* (edited by A.M. Jones and D.C. Poole), pp 62-94. Routledge, London and New York.
- Whipp, B.J., Ward, S.A., Lamarra, N., Davis, J.A. and Wasserman, K. (1982). Parameters of ventilatory and gas exchange dynamics during exercise. *Journal of Applied Physiology*, **52**, 1506-1513.
- Whipp, B.J., Ward, S.A. and Rossiter, H.B. (2005). Pulmonary O₂ uptake during exercise: Conflating muscular and cardiovascular responses. *Medicine and Science in Sports and Exercise*, **37**, 1574-1585.
- Whipp, B.J. and Wasserman, K. (1972). Oxygen uptake kinetics for various intensities of constant-load work. *Journal of Applied Physiology*, **33**, 351-356.
- Wilkerson, D.P., Berger, N.J. and Jones, A.M. (2006). Influence of hyperoxia on pulmonary oxygen uptake kinetics following the onset of exercise in humans. *Respiratory Physiology and Neurobiology*, **153**, 92-106.
- Wilkerson, D.P., Campbell, I.T. and Jones, A.M. (2004a). Influence of nitric oxide synthase inhibition on pulmonary O₂ uptake kinetics during supra-maximal exercise in humans. *Journal of Physiology*, **561**, 623-635.
- Wilkerson, D.P. and Jones, A.M. (2006). Influence of initial metabolic rate on pulmonary O₂ uptake on-kinetics during severe intensity exercise. *Respiratory Physiology and Neurobiology*, **152**, 204-219.

- Wilkerson, D.P. and Jones, A.M. (2007). Effects of baseline metabolic rate on pulmonary O₂ uptake on-kinetics during heavy-intensity exercise in humans. *Respiratory Physiology and Neurobiology*, **156**, 203-211.
- Wilkerson, D.P., Koppo, K., Barstow, T.J. and Jones, A.M. (2004b). Effect of prior multiple-sprint exercise on pulmonary O₂ uptake kinetics following the onset of perimaximal exercise. *Journal of Applied Physiology*, **97**, 1227-1236.
- Wilkerson, D.P., Koppo, K., Barstow, T.J. and Jones, A.M. (2004c). Effect of work rate on the functional 'gain' of Phase II pulmonary O₂ uptake response to exercise. *Respiratory Physiology and Neurobiology*, **142**, 211-223.
- Wilkerson, D.P., Rittweger, J., Berger, N.J., Naish, P.F. and Jones, A.M. (2005). Influence of recombinant human erythropoietin treatment on pulmonary O₂ uptake kinetics during exercise in humans. *Journal of Physiology*, **568**, 639-652.
- Wilson, D.F. (1994). Factors affecting the rate and energetics of mitochondrial oxidative phosphorylation. *Medicine and Science in Sports and Exercise*, **26**, 37-43.
- Woledge, R.C. (1998). Possible effects of fatigue on muscle efficiency. *Acta Physiologica Scandinavica*, **162**, 267-273.
- Yamamoto, Y., Hughson, R.L. and Peterson, J.C. (1991). Autonomic control of heart rate during exercise studied by heart rate variability spectral analysis. *Journal of Applied Physiology*, **71**, 1136-1142.
- Zoladz, J.A., Gladden, L.B., Hogan, M.C., Nieckarz, Z. and Grassi, B. (2008). Progressive recruitment of muscle fibers is not necessary for the slow component of \dot{V}_{O_2} kinetics. *Journal of Applied Physiology*, **105**, 575-580.
- Zuntz, N. (1897). Uber den stoffverbrauch des hundes bei muskellarbeit. *Pflugers Archives of Gestational Physiology*, **68**, 191-211.

