

Modelling Metabolism Based Performance of an Urban Water System using WaterMet²

Kourosh Behzadian^{a,*}, Zoran Kapelan^a

^a Centre for Water Systems, College of Engineering, Mathematics and Physical Sciences,
University of Exeter, Exeter, EX4 4QF, UK

Abstract

This paper presents a new quantitative model called ‘WaterMet²’ for the *metabolism* based assessment of the integrated urban water system (UWS) performance. WaterMet² quantifies a number of UWS flows/fluxes (e.g. water and energy) which can be used to derive sustainability-based performance metrics. The generic WaterMet² model overcomes the drawbacks of the existing UWS models and strives to bridge the gaps related to the nexus of water, energy and other environmental impacts in an integrated UWS. The main features of WaterMet² are: (1) conceptual simulation model of UWS comprised of water supply, stormwater and wastewater subsystems with possible centralised and decentralised water reuse; (2) UWS represented by an arbitrary number of key UWS components for each type in four spatial scales (System, Subcatchment, Local and Indoor areas) in a distributed modelling type approach; (3) quantifying the metabolism-based performance of UWS including the caused and avoided environmental impact categories (GHG emissions, acidification and eutrophication potentials) and resource recovery in UWS. WaterMet² is tested, validated and demonstrated by evaluating the long-term performance of the UWS of a northern European city for three states including business as usual and two intervention strategies: addition of new water resources and large scale localised water recycling. The results obtained demonstrate the effectiveness of WaterMet² in evaluating the sustainability related UWS performance, the suitability of using WaterMet² at the strategic level UWS planning and the importance of using an integrated assessment approach covering the full urban water cycle.

Keywords: Urban water system; WaterMet²; metabolism; performance; environmental impact categories;

1. Introduction

Increasing urban water demands due to population growth is becoming a concern for many water companies (Nair *et al.*, 2014). This is already a major challenge in arid and semi-arid regions where climate change intensifies water scarcity through severe droughts given limited water resources available (Field *et al.*, 2014). On the other hand, climate change and urbanisation are the primary causes of increased urban

* Corresponding author. Tel.: +44 (0)1392 724075; fax: +44 (0)1392 217965.
E-mail address: k.behzadian-moghadam@exeter.ac.uk (K. Behzadian), z.kapelan@exeter.ac.uk (Z. Kapelan).

29 flood in many humid regions (Savic *et al.*, 2013). All this in addition to the overall demand for good water
30 quality in urban areas in the future (UNESCO 2012) imposes considerable stress on water companies to
31 achieve technically and economically acceptable levels of service in the urban water system (UWS). Given
32 ageing infrastructure, retrofitting of UWS is high on the agenda which needs intensive energy demands and
33 subsequently cause a lot of environmental impacts. While achieving the satisfactory levels of services for
34 UWS may be possible through enormous capital investment, meeting certain levels of sustainability criteria
35 must be ensured (Behzadian *et al.*, 2014a). Such a strategy for new interventions in the UWS should
36 consider not only the environmental impacts of the existing UWS operations but also those impacts due to
37 the introduction of new interventions in the future.

38 This aim can be realised within an integrated framework of UWS in which the impact of the interactions
39 between components can be measured concurrently on the whole systems. This approach can form a
40 conceptually based model in UWS with the ability of quantifying metabolism fluxes (Venkatesh and
41 Brattebø, 2011). Such a model is expected to identify the sustainability performance of UWS by using
42 suitable indicators given the growing need for a holistic and sustainable management approach. Modelling
43 the urban water cycle has been of interest for many decades (Rozos *et al.*, 2010). A surge in interest is seen
44 after the mid-1990s and, thereafter, the scope has been widened and the number and types of aspects
45 included in the models have further increased. Several tools have been developed in the recent decades to
46 analyse the sustainability and cost effectiveness of the UWS. Different dimensions of the sustainability
47 framework in water systems, i.e. economic, environmental, social, asset and governance (Alegre *et al.*,
48 2012), have been addressed by these tools. Recently developed tools are *Aquacycle* as a water balance
49 model (Mitchell *et al.*, 2001), *UWOT* as a sustainable water management tool for selection of combinations
50 of water-saving technologies (Makropoulos *et al.*, 2008), *UVQ* as a further modified *Aquacycle* to include
51 contaminant and energy flow (Mitchell and Diaper 2006; Mitchell and Diaper, 2010) and *CWB* as city
52 water balance model (Mackay and Last, 2010), a dynamic model developed by Fagan *et al.* (2010) and
53 *DMM* as a dynamic metabolism model (Venkatesh *et al.*, 2014) to name but a few. A number of
54 commercial integrated water cycle management tools have also been developed in recent years by eWater
55 organisation in Australia such as *MUSIC* as an effective urban stormwater model for assessment of water
56 sensitive urban design, *Urban Developer* as decision-support tool for integrated urban water management
57 and *eWater Source* as a flexible enterprise modelling platform for urban water supply management (eWater
58 2014). The agent based approach has also been used by some models to represent autonomous social
59 behaviours of stakeholders in the sustainability domain of water management (e.g. Valkering *et al.*, 2009).
60 Water, energy and environmental impact categories in UWS are linked through multiple interactive
61 pathways. Essentially, the depth and intensity of those linkages can vary enormously in different UWSs
62 among countries and regions with specific system components (Field *et al.*, 2014). A desirable UWS model
63 should be able to quantify these impacts within a comprehensive framework. Despite a plethora of studies

64 related to the assessment of alternative water management options, a comprehensive literature review by
65 Nair *et al.* (2014) revealed that there is a major gap related to lack of a holistic framework to capture the
66 dynamics of multiple water-energy-greenhouse gas (GHG) linkages in the UWS modelling. A
67 comprehensive assessment of sustainability performance in the UWS is a major challenge for filling this
68 gap. In fact, the sustainability performance are related to measuring not only the footprint of the UWS (i.e.
69 the environmental consequences of feeding volumes of inputs and the focus on the outputs), but also its
70 metabolism, i.e., the environmental consequences of how those inputs are transformed into outputs (Beck *et*
71 *al.*, 2012). The assessment of UWS metabolism from a sustainability-related standpoint is of paramount
72 importance owing to the fact that the understanding of accumulation processes in the urban metabolism is
73 essential for the sustainable development of cities (Kennedy *et al.*, 2007). More specifically, urban
74 metabolism concept, originally developed by Wolman (1965), deals with the quantification of the overall
75 fluxes of energy, water, materials, nutrients and wastes into and out of an urban region. Recent studies from
76 some metropolitan regions demonstrate an increasing per-capita metabolism with respect to all fluxes,
77 which is recognised as an issue threatening sustainable urban development (Kennedy *et al.*, 2007). The
78 literature review manifested the major contribution of urban water-related fluxes to all components of urban
79 metabolism (Kennedy *et al.*, 2011).

80 Despite substantial recent advances in development of urban water management tools, none of them was
81 considered as a truly holistic approach in which the impacts of urban water services in a system component
82 can be evaluated on the overall system performance and external environment (Nair *et al.*, 2014). More
83 specifically, most of the developed conceptual frameworks either consider the modelling between water
84 demand point (starting with potable water from the point where it is delivered) and wastewater systems
85 (Mackay and Last, 2010; Makropoulos *et al.*, 2008; Mitchell and Diaper, 2010; Mitchell *et al.*, 2001) or
86 focus only on water supply systems between water resource and water demand points (Rozos and
87 Makropoulos, 2013). These models have mainly focused on quantification of water flows while other
88 sustainability fluxes such as indirect (embodied) energy fluxes and GHG emissions resulted across the full
89 urban water cycle have been overlooked, or at least not in a systematic and holistic framework. The concept
90 of UWS metabolism was recently introduced by Venkatesh *et al.* (2014) using an annually based dynamic
91 metabolism model (*DMM*). However, no water or any other flow is simulated within the individually
92 separated system components in the *DMM* and the environmental impacts are quantified by multiplying
93 annual water production for each of the system components by a suitable conversion factor.

94 This paper aims to extend the metabolism-based modelling concept outlined here for deriving an
95 integrated, conceptual simulation model based on specific UWS system representation involving all of its
96 principal components and subsystems (i.e. water supply, water demand, sewer and drainage subsystems).
97 This integrated model is called WaterMet² (where 'Met' stands for both metabolism and metropolitan hence
98 ²). This model aims to quantify resource flows in the UWS and consequent environmental impact

99 categories. All this, in turn, will enable undertaking a sustainability assessment of not only the existing
100 UWS but also the UWS modified by some strategic type interventions over a pre-defined long-term
101 planning horizon. In the next section, WaterMet² methodology is described in which the main features and
102 modelling approach are explained in further details. Then, the application of the developed model to the
103 case study is explained and the obtained results are discussed. Finally, the conclusions are drawn and some
104 future work recommendations are made.

105 **2. Methodology**

106 *2.1. General WaterMet² modelling concept*

107 WaterMet² is a conceptual, simulation-type, mass-balance-based model which quantifies metabolism
108 related performance of the integrated UWS with focus on sustainability-related issues. Metabolism in the
109 UWS refers to all kinds of flows and fluxes (e.g. water, energy, materials and so on) required to fulfil the
110 business-as-usual UWS functions (Behzadian *et al.*, 2014b). The integrated modelling implies the
111 simulation of the key processes and components in urban water services as a complex and interrelated
112 system. The main functionality and complexity of WaterMet² for calculating water-related flows is similar
113 to the previously developed tools such as *UVQ* (Mitchell and Diaper, 2010), *UOWT* (Makropoulos *et al.*,
114 2008) and *CWB* (Mackay and Last, 2010). However, once the water-related flows are quantified for each
115 component by simulating the integrated UWS for each time step in WaterMet², other fluxes (Fig. 1) are
116 quantified based on impact coefficients presented by Venkatesh *et al.* (2014). This capability of WaterMet²
117 (i.e. quantifying other metabolism based fluxes, especially the environmental impact categories within the
118 simulation of the integrated UWS) makes it distinct from other counterpart models. The principal water
119 flow routes, storages, sources and sinks modelled in WaterMet² are also illustrated in Fig. 2. A daily mass
120 balance based approach is used for modelling water flows and other fluxes outlined below. The water
121 sources and sinks are the water boundaries. The water storages (e.g. service reservoirs) and flow routes (e.g.
122 trunk mains) stand for any physical assets with the capability of storing and conveying water within the
123 urban area, respectively (see Table 1 for description of their functionality). Also note that despite the fact
124 that life cycle assessment comprises two phases of infrastructure and operation (Fagan *et al.*, 2010),
125 WaterMet² only deals with the functions in the operation (i.e. use) phase of the UWS due to insignificant
126 environmental impacts of infrastructure activities such as construction, installation and demolition (Lundin
127 and Morrison, 2002; Lundie *et al.*, 2004).

128 *2.2. Spatial UWS representation*

129 An UWS comprised of three major subsystems (i.e. water supply, stormwater and wastewater) is
130 represented using four spatial scales in WaterMet² to simulate the principal flows and processes (Fig. 2): (1)

131 System area; (2) Subcatchment area; (3) Local area; (4) Indoor area. The main typical components of the
 132 UWS infrastructure listed in Table 1 (e.g. distribution mains and sewer networks) are defined only in the
 133 System area scale. Water flow between these components comprising the three subsystems is also modelled
 134 at System scale in WaterMet² (see Figs. 2 and 3). Other scales outlined below are used to define input data
 135 required for modelling further details of urban water cycle beyond the UWS infrastructure.

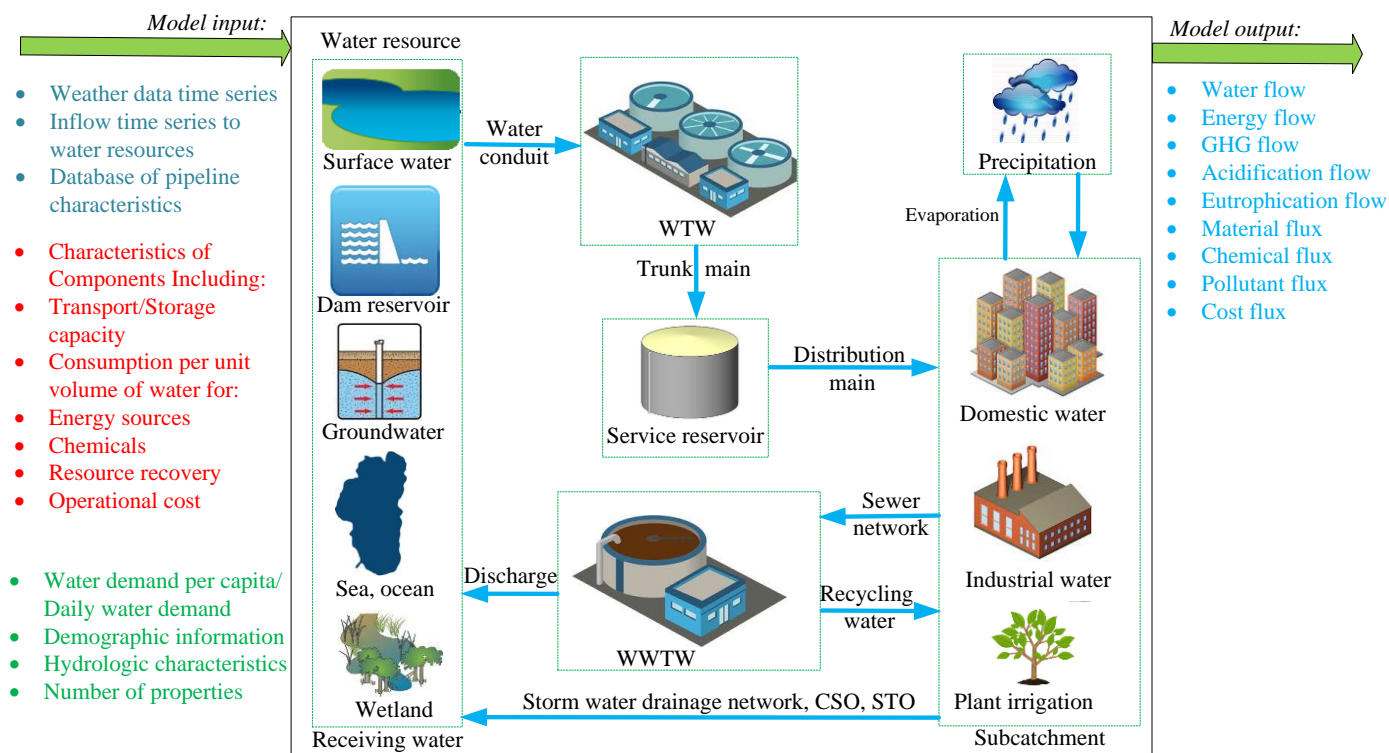

136

137

138

Fig. 1. Main components, processes, inputs and outputs of an urban water cycle used for modelling in WaterMet²

139 The System area spatially can be split up into a number of Subcatchments, which make the use of a
 140 distributed model for the UWS. This split is essentially carried out based on the urban drainage system
 141 considerations (i.e. topology and gravity in stormwater/wastewater collection systems). Subcatchments
 142 serve as 'collection points' in both simplified water supply and separate/combined sewer subsystems. Two
 143 main physical components particularly defined on this level are Subcatchment RWH and GWR tanks
 144 (Table 1). The Subcatchment area in WaterMet² is used to represent a group of neighbouring Local areas.
 145 The Local area shown in Fig. 2 is defined as a group of similar typical households/properties (Indoor scale)
 146 with a surrounding area. A Local area can contain any number of indoor areas (i.e. properties) but they all
 147 must be of the same type, i.e. with identical per capita water demand. The surrounding area is divided into
 148 pervious surfaces, impervious surfaces and water bodies (e.g. lake and river). The main tasks of the Local
 149 area are to handle water demands, rainfall-runoff modelling and on-site water treatment options. In addition
 150 to the per capita water demand specified at Indoor areas, other types of water demand (e.g. irrigation,
 151 industrial/commercial usage) can be defined at this scale based on the average daily consumption per Local
 152 area. WaterMet² uses the rainfall-runoff modelling approach inspired by the Rational Method (Maidment,

153 1992). Two water recycling schemes including Local rainwater harvesting (RWH) and grey water recycling
 154 (GWR) can be defined at this scale. In addition, the sum of wastewater/stormwater collected from different
 155 inside local areas in a Subcatchment is delivered to sewerage and represented as wastewater/stormwater of
 156 the relevant Subcatchment.

157

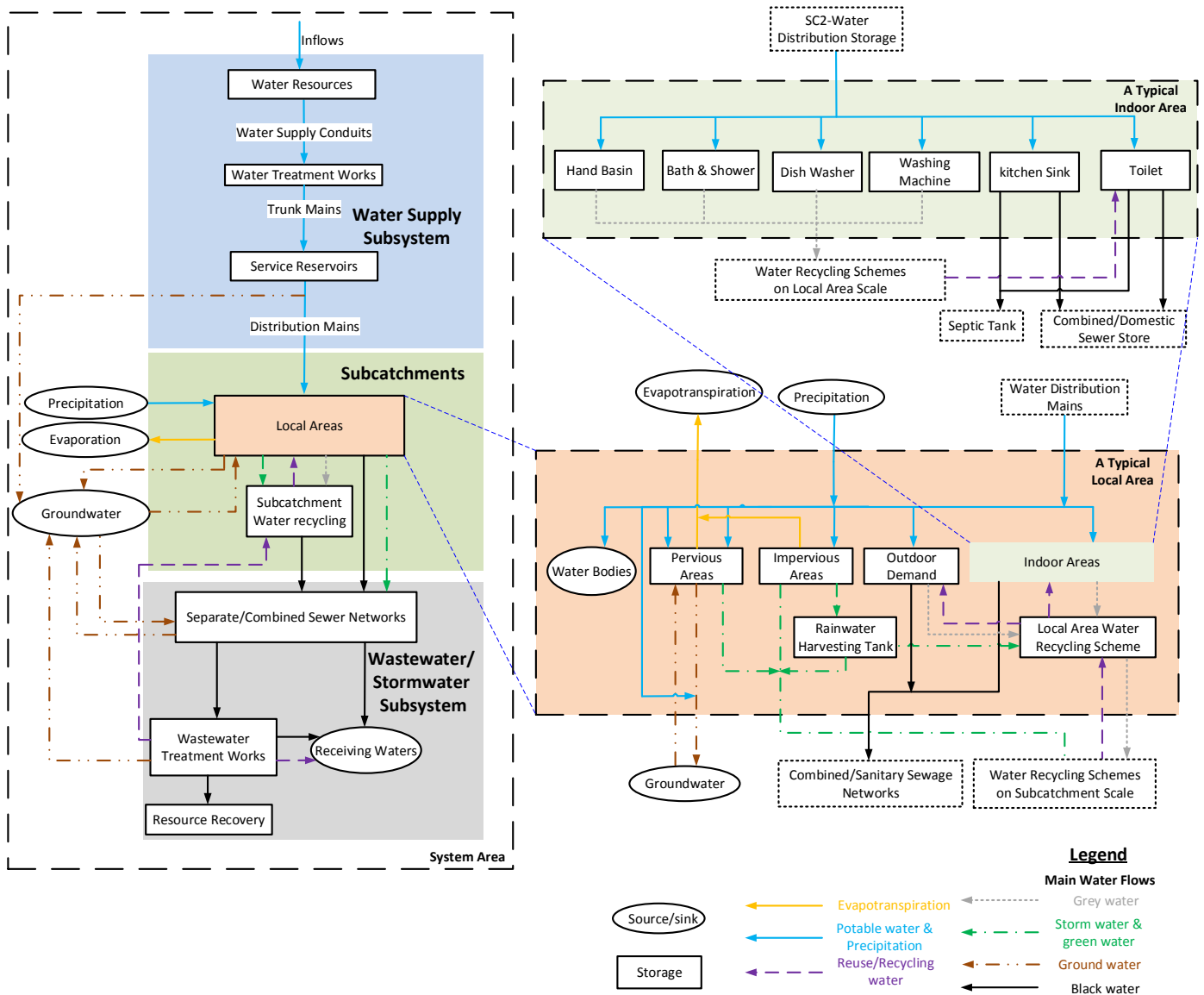

158

159

160

Fig. 2. Principal flow routes, storages and sources/sinks in WaterMet² and its spatial representation.

161

162

163

164

165

166

The Indoor area, as the smallest spatial scale in WaterMet², represents a single property, specifically a household, without any surroundings (e.g. gardens or public open outdoor spaces). Not only residential areas, but any other type of property (e.g. residential, industrial, commercial, public, etc.) can also be represented at this scale. Indoor water demand profiles are defined at this scale based either on the daily average water demand per capita or on detailed information of the water consumption for residential appliances and fittings (Mackay and Last, 2010). For the latter case, the Indoor scale provides the

possibility of defining six types of appliances and fittings as (1) hand basin, (2) bath and shower, (3) dishwasher, (4) washing machine, (5) kitchen sink and (6) toilet.

Table 1 Description and spatial levels of various components and processes modelled in WaterMet²

Component	Description	Spatial Level In WaterMet ²			
		System area	Subcatchment area	Local area	Indoor area
Water supply conduits (SC)	Conveyance of raw water from water resources to WTWs	✓			
Trunk mains (TM)	Conveyance of potable water from WTWs to service reservoirs	✓			
Distribution mains (DM)	Distribution of potable water from service reservoirs among water consumption points	✓			
Combined/separate sewer networks (SN)	Collection of sanitary sewage/ stormwater runoff and conveyance to WWTWs/receiving waters	✓			
WTWs, WWTWs	Treatment of raw water and wastewater	✓			
Service reservoirs (SR)	Potable water storage prior to distributing among the costumers	✓			
Water resources (WR)	Raw water storage	✓			
Grey water recycling tank	Collection and treatment of grey water from water consumption points for water reuse		✓	✓	
Rainwater harvesting tank	Collection and treatment of rainwater from impervious areas for water reuse		✓	✓	
Rainfall-runoff modelling	Conversion of precipitation to surface runoff based on hydrologic specifications			✓	
Water consumption points	Indoor and outdoor water usages			✓	✓

2.3. Temporal UWS representation

As the aim is to support strategic planning, WaterMet² adopts a daily simulation time step to track down all the modelled flows/fluxes (Mackay and Last, 2010; Mitchell and Diaper, 2010). Simulation of smaller time step (e.g. sub-daily) has been proposed by some models (Makropoulos *et al.*, 2008; Fagan *et al.*, 2010) but it requires excessive computational effort while the impact on the water supply reliability has been insignificant (Paton *et al.*, 2014). On the other hand, considering a bigger time step (e.g. monthly) may result in the inaccuracy of the results for the components with a small tank capacity. For instance, RWH tanks with a capacity which is typically of much smaller than water resource capacities can better capture highly fluctuated variations of daily rainfalls. The UWS performance is then simulated typically for a long-term period of time according to the defined planning horizon. Consequently, time series-based input data in WaterMet² (i.e. weather data and inflow to water resources) need to be provided on a daily basis for the time period being analysed.

184 2.4. Principal WaterMet² flows/fluxes

185 WaterMet² within the UWS components tracks down nine principal flows/fluxes including water,
186 energy, GHG, acidification, eutrophication, material, chemical, pollutant and cost which are outlined
187 below. The flows can be aggregated temporally and spatially within the entire UWS to derive the basic
188 performance metrics shown in Table 2.

189 Water flow: WaterMet² recognises various types of water streams (i.e. potable water, green water,
190 greywater, reuse/recycling water, black water/wastewater and groundwater) which are described in
191 appendix I (Makropoulos *et al.*, 2008). The main streams of water flow shown in Fig. 2 are simulated first
192 at different components as a basis for calculating other dependent flows in WaterMet². Clean (potable)
193 water originated from water resources is the only water flow used in water supply and is terminated at
194 water consumption points. Precipitation on both impervious and pervious areas generates stormwater which
195 can be converted to either green water if collected by RWH tanks or wastewater if discharged into sewer
196 networks. If GWR scheme is employed, grey water flow is collected from all assigned water consumption
197 points except toilet and kitchen sink. Recycling (reuse) water flow is then denoted as treated grey/green
198 water by either centralised (i.e. WWTWs) or decentralised (e.g. GWR tanks) schemes. Otherwise, black
199 water is discharged into septic tanks/sewerage and eventually treated in WWTWs. Daily evapotranspiration
200 based on the “preferred” method (Maidment, 1992) is used in WaterMet² to estimate the evaporated flow
201 which is then subtracted from the height of rainfall and snowmelt before the amount of generated runoff is
202 calculated.

203 Energy flux: WaterMet² analyses different sources of energy resulted from resources either consumed
204 (e.g. transmission and treatment) or recovered in the UWS components which are listed in Table 3. The
205 consumed energy resulted from resources consumed is either direct (i.e. fossil fuel and electricity) or
206 indirect (i.e. embodied energy in materials and chemicals). The recovered energy is obtained from
207 substituted fuels, wastewater treatment by-products in WWTWs and generated electricity from either
208 biogas combustion in WWTWs or micro-turbines in water distribution networks. While analysing energy
209 within the UWS components, the energy associated with household water end-users (e.g. water heating for
210 appliances and fittings) is not taken into account in calculation of energy flow in WaterMet².

211 GHG flux: This indicator is considered in WaterMet² due to its dominant factor in climate change and
212 significant effect on other environmental impact categories (Change 2007). Both caused and avoided GHG
213 emissions are calculated in WaterMet² according to Global Warming Potentials with a 100-year time
214 horizon (GWP 100) presented in IPCC (2006). Table 4 gives a list of GHGs (i.e. carbon dioxide (CO₂),
215 methane (CH₄) and nitrous oxide (N₂O) gases) emitted from different UWS components. These modelled
216 emissions are divided into three groups: (1) CO₂ gas emitted (caused GHG) either directly (e.g. fossil fuel
217 combustion) and indirectly (e.g. embodied bodies in materials and chemicals) in all UWS components; (2)

218 CO₂ gas avoided from the resource recovery in some UWS components (e.g. saving embodied energy of
 219 urea production obtained from recovering urea in WWTWs) and (3) emitted CH₄ and N₂O gas resulted
 220 from treatment processes in WWTWs (Metcalf and Eddy 2003). GHG emissions expressed in kg CO₂
 221 equivalent (CO₂-eq) are equal to 1 for CO₂, 25 for CH₄ and 298 for N₂O (Change 2007).
 222
 223

Table 2 Basic metrics derived from flows/fluxes quantified by WaterMet² and the relevant UWS components

Flow/flux	Metric	UWS components ¹	Sources
Water	Water demand (total, potable, delivered, undelivered, delivered rainwater, delivered recycling water, domestic, industrial, irrigation, frost tapping, unregistered public use)	SC, UWS	Mitchell <i>et al.</i> , 2001; Makropoulos <i>et al.</i> , 2008; Mackay and Last, 2010; Behzadian <i>et al.</i> , 2014c
	Inflow (clean water, stormwater, grey water, wastewater, treated/untreated wastewater)	WR, WSC, WTW, TM, SR, DM, SN, WWTW, SRWH, SGWR, LRWH, LGWR, RW	
	leakage	WR, WSC, DM, UWS	
	Outflow (delivered, undelivered, treated) volume, loss, overflow	WR, WSC, WTW, TM, SR, DM, SRWH, SGWR, LRWH, LGWR WR, WTW, SR, WWTW, SN, SRWH, SGWR, LRWH, LGWR	
	STO, CSO, excess stormwater, excess wastewater	SN, UWS	
Energy	Total, electricity, fossil fuel, embodied	All components, UWS	Mitchell and Diaper, 2010; Venkatesh, and Brattebø, 2012
GHG	Total, CO ₂ -based (total, electricity, fossil fuel, embodied), caused, avoided	All components, UWS	Change, 2007; Venkatesh <i>et al.</i> , 2014
	CH ₄ -based, N ₂ O-based	WWTW, UWS	
Acidification	Total, SO ₂ -based (total, electricity, fossil fuel, embodied), caused, avoided	All components, UWS	Tukker and Jansen 2006; Venkatesh <i>et al.</i> , 2014
	NH ₃ -based, NO ₂ -based,	WWTW, UWS	
Eutrophication	Total, PO ₄ -based (total, electricity, fossil fuel, embodied), caused, avoided	All components, UWS	Tukker and Jansen, 2006; Venkatesh <i>et al.</i> , 2014
	NH ₃ -based, NO ₃ -based, COD to water, Phosphorous with effluent	SC, SN, WWTW, RW, UWS	
Material	Mass, length	DM, SN, UWS	Venkatesh, 2012
Chemical	Mass	WTW, SR, WWTW, UWS	Mitchell and Diaper, 2010;
Pollutant	Contaminant load (inflow, outflow), generated sludge	SN, WWTW, SRWH, SGWR, LRWH, LGWR, RW, UWS	Mitchell and Diaper, 2010; Behzadian and Kapelan, 2013
	Contaminant load (total, treated WWTW outflow, untreated WWTW outflow, untreated STO)	SN, WWTW, RW, UWS	
Cost	Operational	All components, UWS	Behzadian and Kapelan, 2013

¹ Please see appendix I for the notations used in this Table.

224
225

226 Acidification/eutrophication flux: Acidification and eutrophication (also known as nitrification)
 227 potentials are considered in WaterMet² because they are the most major impact categories in urban water
 228 cycle services compared to other commonly used environmental impact categories (Venkatesh and Brattebø
 229 2012). Three major acidifying gas emissions in water systems are sulphur dioxide (SO₂), ammonia (NH₃)
 230 and nitrogen dioxide (NO₂) (Tukker and Jansen 2006) which are calculated in WaterMet² as caused and
 231 avoided acidification flux. Eutrophication flux is calculated by WaterMet² as emissions to both atmosphere
 232 and water in the forms of ammonia gas, nitrate to water, COD to water and phosphorous with effluent as
 233 listed in Table 4 in the UWS components. Acidification and eutrophication fluxes are finally converted and
 234 expressed in kg of SO₂-eq and PO₄-eq, respectively. Characterisation factor for each kg of the above gases
 235 to these equivalent units were extracted from the *DMM* (Venkatesh *et al.*, 2014) and equal to 2.45 for NH₃
 236 and 0.56 for NO₂ in acidification and 3.8 for ammonia, 4.4 for nitrate, and 1 for COD in eutrophication.

237
 238 **Table 3** Consumed and recovered resources modelled by WaterMet² in the relevant components

	Source type	Instances supported by WaterMet ²	WaterMet ² UWS components ¹
Resource consumed	Electricity	Electricity from grid	All components
	Fossil fuel	Coal, diesel, fuel oil, gasoline, LPG, natural gas and wood	All components
	Material	Polyvinyl chloride (PVC), polyethylene (PE), mild steel, ductile iron, grey cast iron, concrete, epoxy resin, polyurethane (PUR), copper, polypropylene (PP)	WSC, TM, DM
	Chemical	Alum, carbon dioxide, calcium hydroxide, PAX, sodium hypochlorite, chlorine, iron (ferric) chloride, iron (ferric) sulphate, nitric acid, methanol, ethanol, sodium hydroxide, potassium permanganate, ozone, silica sand/micro-sand	SR, WTW, WWTW
Resource recovered	Substituted fuel	Heat, transport fuel	WWTW
	By-product	Ammonium nitrate, urea, single superphosphate, biogas	WWTW
	Electricity generated	Electricity generated from biogas combustion Electricity generated from micro-turbine	WWTW WSC, TM, DM

239 ¹ Please see appendix I for the notations used in the Table

240
 241 Material flux: WaterMet² tracks down only those pipeline materials which are used in the operation (i.e.
 242 rehabilitation), not in the construction of either the existing infrastructure or any new development. Thus,
 243 WaterMet² quantifies the impacts of the material flux on other fluxes/flows (environmental impacts and
 244 cost) according to the approach suggested by Venkatesh (2012) using a number of key features of pipeline
 245 (i.e. length, material, diameter and age). The environmental impacts in the material flux basically originate
 246 from both direct (e.g. fossil fuel used for rehabilitation) and indirect (e.g. embodied energy) causes

247 (Behzadian *et al.*, 2014b). These impacts can be due to either interventions (e.g. rehabilitation of existing
 248 pipes) or simply long-term ageing (i.e. 'doing nothing') of the UWS infrastructure.

249 Chemical flux: WaterMet² quantifies the environmental impacts of a number of chemicals (listed in
 250 Table 3) which are used for treatment purposes in some UWS components (WTWs, WWTWs and service
 251 reservoirs). The impacts in those components mainly stem from the embodied energy of chemicals. The
 252 consumption of ethanol and methanol in WWTWs for wastewater treatment processes can directly emit
 253 CH₄ gas and thus cause GHG emissions (Table 4).

254 **Table 4** Caused and avoided environmental impacts modelled by WaterMet².

GHG emissions	Caused and avoided CO ₂ equivalent from resources consumed and recovered in Table 3
	Caused CO ₂ gas emissions from using methanol and ethanol in WWTW
	Caused CH ₄ gas emissions from incomplete biogas combustion in WWTW
	Caused fugitive CH ₄ gas emissions from sludge end-users (landfill and fertiliser) in WWTW
	Caused fugitive N ₂ O gas emissions from sludge end-users (landfill and fertiliser) in WWTW
	Caused N ₂ O gas emissions during wastewater treatment in WWTW
Acidification	Caused and avoided SO ₂ equivalent from resources consumed and recovered in Table 3
	Caused fugitive NH ₃ gas emissions from sludge end-users (landfill and fertiliser) in WWTW
	Caused NH ₃ gas emissions from incomplete biogas combustion in WWTW
	Caused NO ₂ gas emissions from incomplete biogas combustion in WWTW
	Caused SO ₂ gas emissions from biogas combustion in WWTW
Eutrophication	Caused and avoided PO ₄ equivalent from resources consumed and recovered in Table 3
	Caused fugitive NH ₃ gas emissions from sludge end-users (landfill and fertiliser) in WWTW
	Caused phosphorous content of effluent in Table 2
	Caused carbon content (COD) of effluent in Table 2
	Caused nitrogen (nitrate) content of effluent in Table 2

255
 256 Pollutant flux: Water quality modelling in WaterMet² is confined to stormwater and wastewater
 257 subsystems (Makropoulos *et al.*, 2008). While a simplified water quantity modelling assumes a daily mass
 258 balance of the water flows without any travel time of water quality routing, sequential daily water quality
 259 modelling allows tracking of any contaminant loads. Hence, a daily flux of user-defined pollutants is used
 260 in WaterMet² and expressed as load of contaminants (kg/day). The modelling is based on the source-sink
 261 concept and complete mixing assumptions with no dispersion, diffusion, decay or growth for pollutants
 262 (Mitchell and Diaper, 2010). Hence, a user-defined pollutant load is tracked down wherever generated (i.e.
 263 wastewater or runoff) or removed (i.e. treatment) once reaching a sink (i.e. receiving waters).

264 Cost flow: WaterMet² directly calculates operational and maintenance (O&M) costs as either fixed (e.g.
 265 labour and maintenance) or variable (e.g. electricity) within the UWS components. The user-defined annual
 266 fixed costs is converted into the equivalent daily values for calculation of cost flow. Variable operating
 267 costs are defined based a unit volume of water consumed and calculated accordingly for each component
 268 after simulating the daily water flow. To derive the financial metrics especially for comparing different

269 intervention strategies added at different periods of time, WaterMet² can discount the cost flow to any
 270 specific times based a pre-defined interest rate.

271 **2.5. Modelling of principal UWS components in WaterMet²**

272 Potable water supply and collection of wastewater and stormwater are handled in WaterMet² through a
 273 simplified but integrated approach of a distributed model comprised of the three subsystems shown in Fig.
 274 3. The water supply in WaterMet² comprises three types of ‘storage’ components (i.e. water resources,
 275 WTWs and service reservoirs) and three types of ‘flow route’ elements including water supply conduits
 276 (SC), trunk mains (TM) and distribution mains (DM). Subcatchments serve as water consumption points for
 277 water supply and wastewater/stormwater collecting points for wastewater/stormwater subsystems. Other
 278 key components modelled in the wastewater /stormwater subsystems are separate/combined sewer
 279 networks (SN) as flow route, WWTWs as storage, receiving waters as sink. Wastewater and runoff
 280 generated in Local areas are aggregated to Subcatchment ‘points’ where they are delivered to flow routes in
 281 the relevant Subcatchment sewer networks.

282

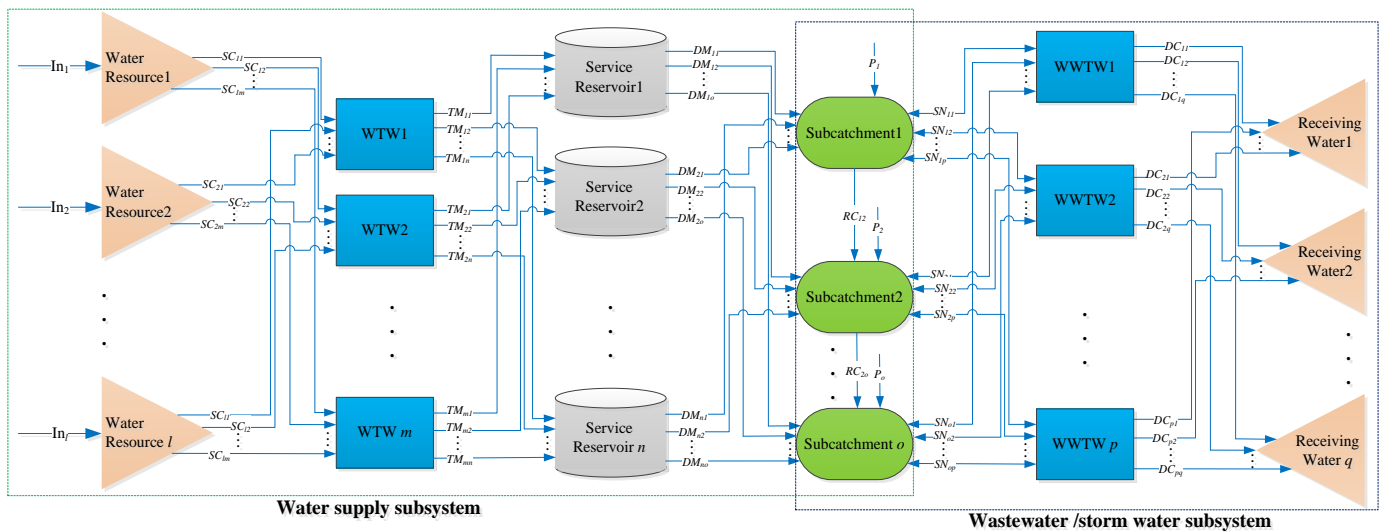

283

284

Fig. 3. Schematic representations of the main ‘storage’ and ‘flow route’ components modelled in WaterMet²

285

286 Simulation of the water supply subsystem in WaterMet² follows a two-step approach of a typical water
 287 supply system (Loucks *et al.*, 2005). The first step deals with the calculation of daily water demand in the
 288 modelled components starting from the most downstream points (i.e. Local areas/Subcatchments)
 289 aggregated up to the most upstream points (i.e. water resources). The calculated water demands are added
 290 by leakages of conveyance elements (Mitchell and Diaper 2010). For instance, the daily volume of water
 291 demand for water resource *i* and day *t* (RD_{it}) is calculated in Eq. (1) by adding the leakage percentage
 292 pertaining to conduit SC_{ij} (CL_{ij}) to the water demand of that conduit:

$$RD_{it} = \sum_{j=1}^m CF_{ij} \times WD_{jt} (1 + CL_{ij}/100) \quad (1)$$

where WD_{jt} =water demand of WTW j ; CF_{ij} = pre-specified fraction of water demand in resource i from WTW j by conduit SC_{ij} ; m =number of WTWs. Once the water demand of water resources is determined, the second step starts off with water withdrawal and conveyance to downstream elements sequentially in which capacity control of storage components (i.e. both minimum and maximum) are the only governing equations. The released/abstracted water is finally distributed among Subcatchments and consequently water consumers. Mass balance relationship expressed in Eq. (2) is applied to calculate the water volume of a storage component in consecutive days:

$$S_{i,t+1} = S_{i,t} + I_{i,t} - D_{i,t} \quad (2)$$

where $S_{i,t}$ and $S_{i,t+1}$ =volume of component i for day $t+1$ and t , respectively; $I_{i,t}$ =inflow to component i for day t and $D_{i,t}$ =output for component i for day t . After water consumption, a percentage of consumed water (typically over 90% for domestic and 85-95% for non-domestic (Metcalf and Eddy, 2003)) is converted to sanitary sewage (grey water or black water) and the rest is assumed to be lost. The stormwater runoff and sanitary sewage in the local areas of each Subcatchment are aggregated at the Subcatchment outlet point where they are collected by sewer flow routes in the conceptual sewer subsystem (Fig. 3). The wastewater are then delivered to WWTWs based on the pre-specified fraction for each sewer network flow route (SN_{ij}). Finally, the treated wastewater flow is either discharged into receiving water bodies based on a pre-specified fraction for each discharge route (DR_{ij}) or recycled to Subcatchments for water reuse. Once the daily water flow rate is calculated for each component based on the methodology outlined above, other flows/fluxes dependent to water flow (e.g. energy and GHG emissions) are calculated by multiplying the amount of the water conveyed/treated by a constant flux consumed per unit volume of water, which is specified as input data of WaterMet².

2.6. Data requirement in WaterMet²

A WaterMet² model is constructed based on an arbitrary number of UWS components for each type (Fig. 3). The key functional characteristics of each component are required as input data, e.g. storage and transport capacity, energy and cost per unit volume of water (Behzadian *et al.*, 2014c). Water demand profiles as well as their temporal variations over the planning horizon need to be defined to consider seasonal and annual fluctuations. The former is defined using a consumption pattern in a year and the latter is defined based on a time-series of annual population growth in Local areas. The WaterMet² spatial scales (e.g. number of Subcatchments /Local areas) can provide more flexibility for defining the analysed system. More specifically, these scales can be used to represent a relatively large (or small) spatial area depending on the size and type of the urban area being analysed and also on the level of spatial resolution required and

the available data in different scales. For instance, if there is a lack of available data for defining a variety of Subcatchments in a System area, one can consider the System area with a limited number of Subcatchments bearing in mind that the reduced level of details modelled will have an impact on the accuracy of the calculated flows and associated variables.

3. Case Study

3.1. Urban water system description

The case study used here is a real-life urban water system of a northern European city. The application of the WaterMet² model is demonstrated here on the challenges of a long-term planning for this UWS. The city is likely to face challenges in the future due mainly to population growth. Therefore, it is assumed that the future water demand will increase as a consequence of the highest foreseen rate of population growth in the city, i.e. it is assumed that the city population will increase from approximately 610,000 inhabitants in 2011 to the estimated 1,150,000 inhabitants by 2040. This is likely to impose significant strains on the UWS performance. The existing UWS, as schematically shown in Fig. 4, is fed by two main surface water resources (WR1 and WR2) connected to corresponding WTWs (WTW1 and WTW2) and service reservoirs (SR1 and SR2). These two sources provide fresh water for the city with 90% of water being supplied from WTW1 and 10% from WTW2. The existing distribution networks are connected to the two respective upstream service reservoirs by means of two distribution mains (DM1 and DM2) proportional to the capacity of the existing water supply. Both of the surface water resources, on which the city relies, are of limited capacity (120 and 13.8 million cubic metres (MCM)). The corresponding average annual inflows for WR1 and WR2 are 287 and 12 MCM/year, respectively. The leakage from the Subcatchment pipelines is currently 22% of total water demand. The existing sewer network represents a mix of 37% combined sewers, 30% sanitary sewers and 33% storm drains. Two WWTWs, collecting 63% (WWTW1) and 37% (WWTW2) of the wastewater flows, and sewer network overflows (i.e. CSOs) discharge the treated and untreated wastewater /stormwater into the downstream sea (RW1) as the only receiving water body. The main characteristics of the key UWS components (input data) are presented in Table 5.

The UWS model is represented here as an aggregated model using a single WaterMet² Subcatchment with a single Local area used to define the water consumption. The water demand of the single Local area is split into domestic, industrial (commercial), garden watering, frost tapping and unregistered public use with the characteristics presented in Table 6. The frost tapping water demand is the water required to flow through the main pipelines in the UWS over the freezing time in the city (i.e. from November 1 until March 31). The unregistered public use water demand is applied for sum of the authorised and unauthorised consumptions which are not accounted for billing customers. The domestic (indoor) water demand per capita in the city is further split into six types of appliances and fittings given in Table 6.

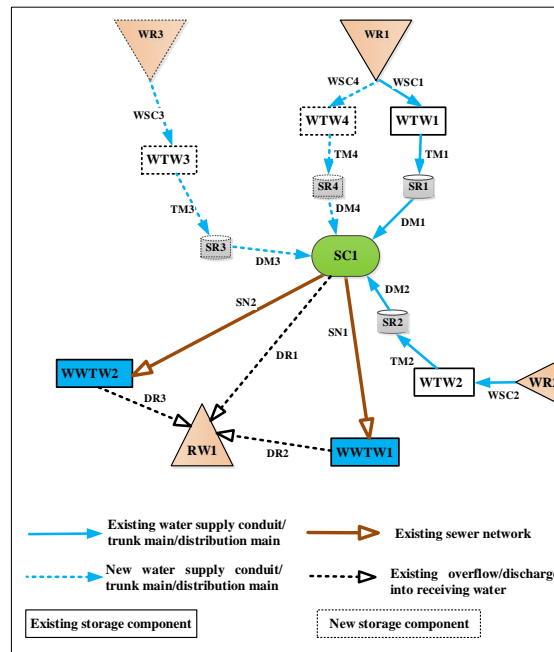

Fig. 4. Schematic diagram of the analysed UWS components

Table 5 Key characteristics of the UWS components

Component	Capacity (ML/day)	Electricity (kWh/m ³)	Fossil fuel (×10 ⁻³ L/m ³)	Fixed annual cost (Million €)	Avg. chemical cost (€/m ³)
WTW1	370	0.343	2.40	12.06	0.017
WTW2	43.2	0.343	2.40	1.34	0.017
Distribution main	413.2	0.44	3.98	13.94	-
Sewer networks	2200* ML	0.018	0.59	10.92	-
WWTW1	770	0.462	0.064	6.88	0.027
WWTW2	320	0.462	0.064	4.04	0.027

* Transmission capacity of sewer networks can be defined as either daily transmission capacity in ML/day or storage type transmission capacity with a storage capacity in Million Litre (ML). For the latter, daily transmission release (Q) is defined as a function of available volume (V) as $Q=a \times V^b$ where a and b are the parameters which are adjusted in the model calibration. Here, storage type transmission capacity is employed with calibrated parameters of $a=0.2$ and $b=1.0$

Table 6 Input parameters of the UWS water demands

Parameter description	Value	Appliances and fittings of	% of indoor water
		indoor area	demand
Number of households in year 2011	320,000	Dish washer	3.2
Average occupancy per household	2.35	Hand basin	12
Indoor water demand	180 L/day/capita	Kitchen sink	12.8
Industrial water demand	54.8 ML/day	Washing machine	16
Garden watering demand	63.5 ML/day	Shower	25
Frost tapping water demand	35 ML/day	Toilet	30

370 3.2. WaterMet² model building and calibration

371 The WaterMet² model used in the case study presented here was built by a single person over a period of 12
372 months once the relevant data was provided by the water company. After model building, the model was
373 then calibrated by using the historical daily measurements for both water and wastewater production. Here,
374 a manual, trial and error approach was employed to calibrate both water supply and stormwater/wastewater
375 subsystems sequentially. Water supply subsystem was first calibrated and validated by using the available
376 data (i.e. two years of recorded daily water production at the WTWs split into two periods using 2011 for
377 calibration and 2012 for validation). The calibration parameters for water supply part include: (1) monthly
378 coefficients of water demand profiles; (2) percentage contribution of daily temperature in daily variation of
379 water demand profiles. The stormwater/ wastewater subsystem was subsequently calibrated for two years
380 (2010-2011) of recorded daily wastewater inflows to the WWTWs, again split into two one-year periods for
381 calibration and validation. The relevant calibration parameters are hydrologic parameters of the
382 Subcatchment (i.e. perviousness, imperviousness and rainfall-runoff coefficients) and the principal
383 hydraulic features of the WWTWs and sewer networks (i.e. storage capacity). Fig. 5 shows a graphical
384 comparison of the model performance for the validation period in both subsystems plotting the simulated
385 versus observed values. Although both graphs show a fair amount of scatter around the 1:1 slope line, the
386 simulated results in both parts of the integrated model are reasonably close to the observed values.
387 Furthermore, Fig. 6 shows the performance of the stormwater/ wastewater part of the WaterMet² model
388 during the calibration and verification periods based on a comparison between observed and simulated
389 values. As it can be seen from this figure, the simulated values match the observed values reasonably close
390 for both hydrographs.

391

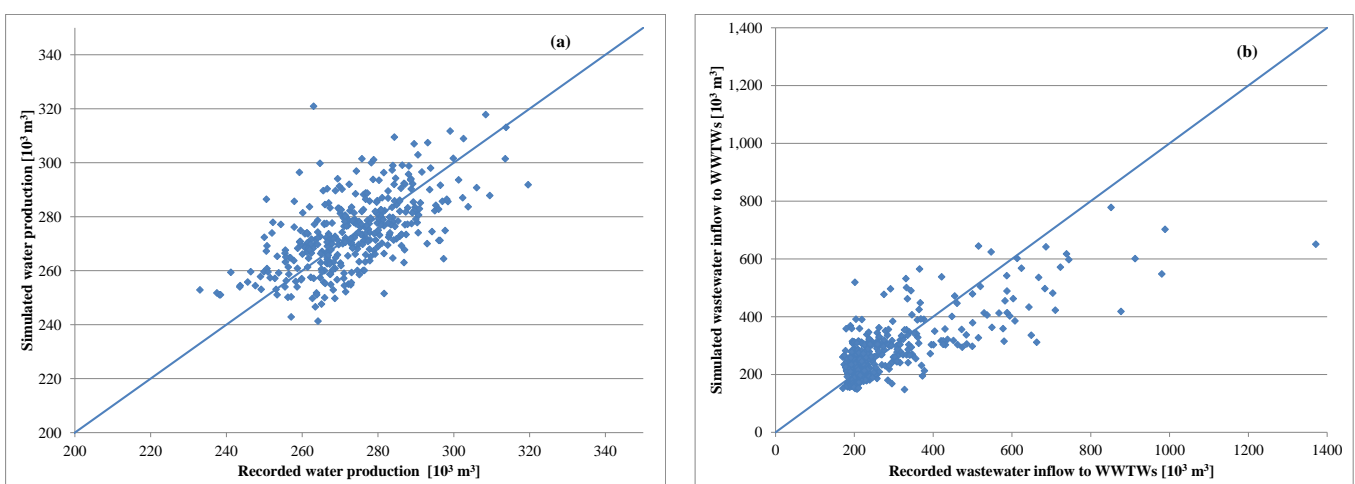

392 **Fig. 5.** Daily simulated result in WaterMet² versus recorded values for validation period in

393 (a) water production (b) wastewater inflow to WWTWs

394

395

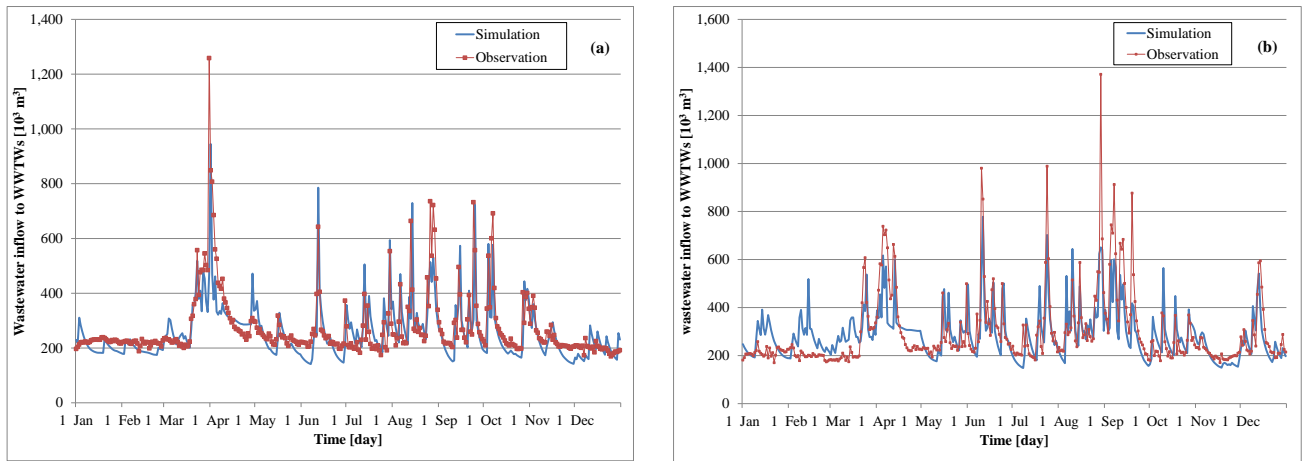

Fig. 6. Daily simulated versus recorded wastewater inflow to WWTWs for the periods of (a) calibration (2010) and (b) validation (2011)

Further evaluation of the model performance was undertaken by measuring three quantitative statistics recommended by Moriasi *et al.* (2007): (1) *the Nash-Sutcliffe efficiency (NSE)* with an optimal value of 1.0 and an acceptable range between 0.0 and 1.0; (2) *RMSE-observations standard deviation ratio (RSR)* and (3) *Percent bias (PBIAS)*, both with the optimal value of 0.0. Results of the statistics of the simulated performance (Table 7) indicates a reasonably good prediction accuracy of the wastewater subsystem when compared to the recommended values of hydrologic flows (i.e. $NSE \geq 0.5$, $RSR \leq 0.7$ and $PBIAS < 25\%$) by Moriasi *et al.* (2007). In addition, the accuracy achieved with the wastewater part of the model is better than the water supply part of the model. This can be attributed to the fact that daily water demands are highly variable over a year, not necessarily corresponding with temperature and calendar monthly variations defined by the WaterMet² model but other impacts such as human behaviours (e.g. tourism and holidays). Having said this, this is not uncommon and similar accuracy for the water demand based calibration has been reported in previous conceptual models such as *Aquacycle* (Mitchell *et al.*, 2001) and *CWB* (Mackay and Last, 2010). The model accuracy can be improved either by increasing the amount of measured data used in calibration and/or through automated (e.g. optimised) calibration.

Table 7 Simulation performance of the WaterMet² model

	Water supply subsystem		Stormwater/wastewater subsystem	
	Calibration	Validation	Calibration	Validation
NSE	0.25	0.22	0.51	0.56
RSR	0.86	0.89	0.70	0.67
PBIAS (%)	-0.50	-0.30	6.02	2.45

416 3.3. Performance assessment using WaterMet²

417 To demonstrate the performance capability of the WaterMet² model, the metabolism related performance
418 of the UWS is evaluated first assuming business as usual (BAU), i.e. effectively ‘do nothing’ in the UWS
419 over the planning horizon 2011-2040. The BAU assumes no (capital type) interventions will be
420 implemented in the UWS over the planning horizon under the assumed highest rate of population growth
421 scenario. Therefore, deterioration of the UWS performance such as increased unmet water demand is likely
422 to happen in the BAU. This performance is then compared to the performance of the UWS modified by two
423 different interventions which make the following intervention strategies.

424 Intervention strategy 1 (S1): the first intervention assumes the “addition of water resources” in year 2020
425 comprised of a new water resource WR3 (capacity of 13,000 MCM), the two associated WTWs (WTW3
426 and WTW4) and two corresponding service reservoirs (SR3 and SR4) shown in Fig. 4. Intervention
427 strategy 2 (S2): the second intervention is based on large scale “water recycling” starting in year 2015 and
428 is comprised of adding a single mix of both RWH and GWR schemes at the Local area scale. It is assumed
429 that the RWH scheme collects runoff from roofs, roads and pavements and supplies water only for toilet
430 flushing, garden watering and industrial usages. Each household RWH scheme is assumed to have 3 m³ of
431 tank capacity with an annual operational expense being €72/year (Ward *et al.*, 2012). The electricity
432 required for the operation of the RWH scheme is estimated to be 0.54 kWh/m³ (Ward *et al.*, 2012;
433 Behzadian *et al.*, 2013). A single RWH scheme located in the Local area with an adoption rate of 50% of
434 households assumes to represent many small domestic RWH units across the city. The GWR scheme
435 collects grey water (i.e. from the hand basin, dish washer, shower, washing machine and frost tapping) and
436 recycles the treated grey water for the provision of toilet flushing, irrigation and industrial uses. The
437 electricity consumption for treatment of grey water is assumed to be 1.84 kWh/m³ (Memon *et al.*, 2005). A
438 single representative GWR scheme for 50% of household adoption is assumed to have a total volume of
439 39,000 m³ with an operational cost of €1.50 million/year.

440 In general, the performance of the UWS should be evaluated against the agreed-upon criteria derived
441 from the different dimensions of the sustainability framework in water systems including social,
442 environment, economic, governance and assets (Alegre *et al.*, 2012; Morley *et al.*, 2014). For illustrative
443 purposes, the two intervention strategies are compared here with respect to the following sustainability
444 criteria quantified by WaterMet²: O&M cost, percentage of water demand delivered and the three
445 categories of environmental impacts. Note that setting up the case study (e.g. intervention options and
446 metrics) and analysing the results took further 6 months of a single person.

447 **4. Results and discussion**

448 The integrated UWS modelled by WaterMet² is first simulated in the BAU for a period of 30 years
 449 starting from 2011 with a daily time step. Due to increasing water demand over the planning horizon, the
 450 UWS in the BAU encounters unmet water demand starting from 2013 (Fig. 7). The water undelivered is
 451 rather small initially but as the population size increases the water shortage increases eventually up to 27%
 452 toward the end of the planning horizon. Following this, the two aforementioned intervention strategies were
 453 applied and the modified UWS was simulated using the WaterMet² model. Comparing monthly percentage
 454 of water demand delivered in both intervention strategies indicates that strategy 1 can successfully cope
 455 with the increased water demand although a trivial percentage of unmet water demand (3%) occurs during
 456 the end years of the planning horizon. However, the delivered water demand obtained in the case of the
 457 second strategy, although significantly improved compared to the BAU, is less favourite than the first
 458 strategy due to unmet water demand up to 14%. The impact assessment of the two strategies is further
 459 carried out using the other WaterMet² metrics in more details by different components and time scales. The
 460 purpose of this distinction is to demonstrate the assessment of the impact of the intervention strategies on
 461 different environmental impact categories.

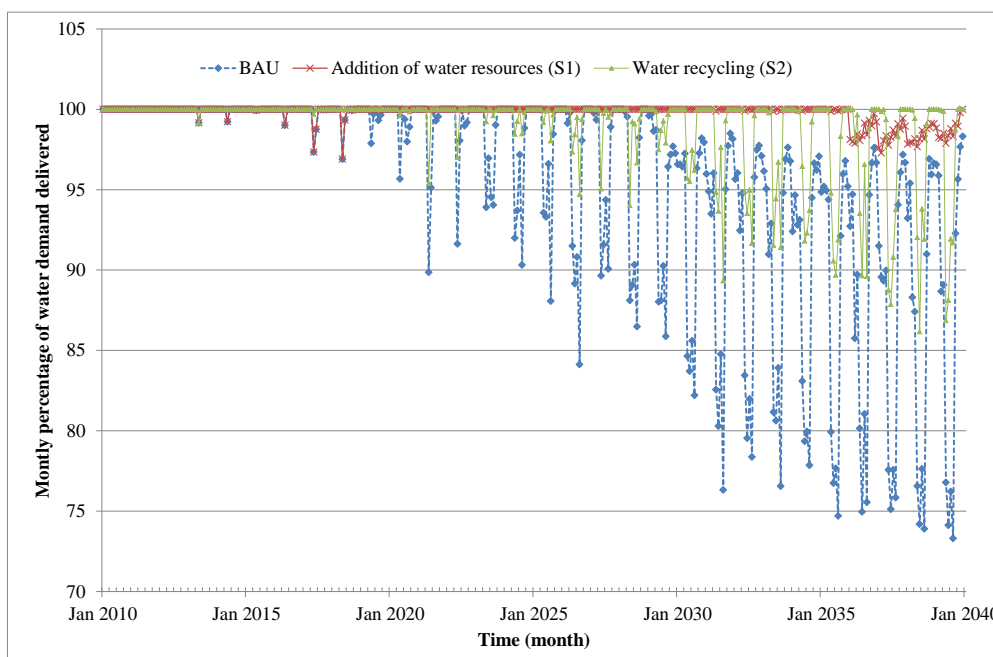

462 **Fig. 7.** Monthly variations of percentage of delivered water demand over the planning horizon for the analysed strategies
 463
 464

465 Comparing the GHG emissions resulted from the BAU and other two intervention strategies (Table 8)
 466 shows that CO₂ is the major factor in emitting GHG (~50%) for all strategies due mainly to the high
 467 consumption of electricity and embodied energy within the components especially WWTWs. Almost over
 468 one third of all emitted GHG originates from N₂O gas in WWTWs as a result of emissions from treatment
 469 processes. While strategy 1 increases 10% the share of GHG emissions in water supply subsystem (from 49

470 to 54×10^3 ton CO₂-eq as sum of GHG emissions of WR, WTW and DM in Table 8), it has no effect on the
471 GHG emissions in wastewater/stormwater subsystems. The increased impact in water supply subsystem is
472 expected as this intervention strategy aims to improve the water/supply balance and thus provide more
473 fresh water in the water supply which consequently demands more energy. In spite of improving water
474 supply subsystem by strategy 1, the increased water supplied in this strategy ends up in the increased
475 wastewater/combined sewer subsystem as Dry Weather Flow (DWF). However this additional wastewater
476 would result in an insensible impact on wastewater/stormwater subsystem (i.e. WWTWs and sewer
477 networks) probably due to its partial contribution in wastewater subsystem compared to stormwater flow.

478 On the other hand, strategy 2 is able to reduce the GHG emissions by approximately 4 and 7 percent in
479 water supply and wastewater/stormwater subsystems, respectively. Overall, the GHG emissions in strategy
480 1 will increase by almost 2% but can decline in strategy 2 by approximately 7% (Fig. 8(a)). The resulting
481 acidification potentials only refers to SO₂ emissions mainly due to energy consumption in the UWS in
482 which WWTWs are accounted for the greatest acidification producer (~90% of the total SO₂) as shown in
483 Fig. 8(b). Furthermore, strategy 1 has a negligible impact on increasing acidification of the UWS (~1%)
484 whilst strategy 2 will be able to alleviate it by approximately 10%. All this concludes that WWTWs are the
485 main driver of all sources of GHG emissions (over 77%) and acidification potential (over 88%) in the UWS
486 (Table 8). Therefore, any intervention strategies (e.g. novel technologies) improving the WWTW activities
487 (e.g. biogas recovery efficiency) may play an important role to significantly alleviate the UWS
488 environmental impacts (Zakkour *et al.*, 2002). This corresponds with the previous researches which mainly
489 focused on the reduction in GHG emitted from WWTWs to attain the UWS sustainability (Mouri and Oki,
490 2010; Nair *et al.*, 2014).

491 The major sources of eutrophication in the UWS as seen in Table 8 originate from COD to water (~60%)
492 and NO₃ to water (~40%). These impacts are mainly owing to overflows of the sewer networks into
493 receiving water bodies compared to treated/untreated discharge of WWTWs. Other sources of
494 eutrophication which result in PO₄ emissions are almost negligible compared to the total eutrophication
495 obtained. The contribution of the sewer networks and WWTWs to eutrophication are 55% and 45% of the
496 total amount in the BAU, respectively. Strategy 1 has almost no change to the total eutrophication amount
497 but strategy 2 is able to reduce it by over 20% (see also Fig. 8(c)). This can be attributed to the fact that
498 strategy 2, owing largely to RWH and GWR tanks, can reduce the discharge of contaminants into receiving
499 water bodies. More specifically, the determining factor for reducing eutrophication in this strategy is the
500 31% reduction in COD discharges from sewer networks, resulted mainly from runoff washing off the
501 contaminant over the urban surfaces. In addition, both recycling schemes directly deteriorate the
502 environmental impact categories due to electricity consumption. However, the major sources of the adverse
503 environmental impacts (e.g. CO₂, N₂O, NH₃, NO₃ and COD) in this strategy (S2) have decreased more
504 compared to those in strategy 1 for all components. This can be attributed to the fact that the recycling

schemes simultaneously reduce both potable water demand in water supply subsystem and wastewater/stormwater discharged into sewerage and thus indirectly influence the associated environmental impact categories. Consequently, the indirect impacts of this strategy overcome the direct ones.

Table 8 Simulated performance of the WaterMet² model

Environmental impact categories	Emissions	Component	BAU		Addition of water resources (S1)		Water recycling (S2)	
			value ¹	percentage [%]	value ¹	percentage [%]	value ¹	percentage [%]
GHG emissions	CO ₂	WR	0	0	2	1	0	0
		WTW	31	14	33	14	25	12
		DM	18	8	19	8	15	7
		SC	0	0	0	0	7	3
		SN	1	1	1	1	1	1
		WWTW	65	28	65	28	59	27
		Total	115	50	120	51	107	50
	CH ₄	WWTW	31	14	31	13	28	13
	N ₂ O	WWTW	82	36	82	35	78	37
	Total	UWS	229	100	233	100	213	100
Acidification	SO ₂	WR	0	0	3	0	0	0
		WTW	72	8	76	8	58	7
		DM	33	3	35	4	26	3
		SC	0	0	0	0	13	1
		SN	2	0	2	0	2	0
		WWTW	851	89	851	88	771	89
		Total	958	100	967	100	870	100
	NH ₃	WWTW	0	0	0	0	0	0
	NO ₂	WWTW	0	0	0	0	0	0
	Total	UWS	958	100	967	100	870	100
Eutrophication	PO ₄	WR	0	0	1	0	0	0
		WTW	31	0	33	0	25	0
		DM	9	0	10	0	7	0
		SC	0	0	0	0	4	0
		SN	1	0	1	0	0	0
		WWTW	-26	0	-26	0	-24	0
		Total	15	0	19	0	14	0
	NH ₃	WWTW	0	0	0	0	0	0
	NO ₃	SN	1,962	10	1,962	10	1,337	9
		WWTW	5,254	28	5,254	28	4,999	33
		Total	7,216	38	7,216	38	6,336	42
	COD	SN	8,475	45	8,475	45	5,850	39
		WWTW	3,227	17	3,227	17	2,898	19
		Total	11,701	62	11,701	61	8,748	58
	Phosphorus	SN	62	0	62	0	41	0
		WWTW	38	0	38	0	34	0
Total		100	1	100	1	76	0	
Total	UWS	19,015	100	19,036	100	15,173	100	

¹ Unit of the quantity is 10³ Ton CO₂-eq per capita for GHG emissions, Ton SO₂-eq per capita for acidification and Ton PO₄-eq per capita for eutrophication. The negative values also imply that avoided environmental impacts is greater than caused ones

Moreover, comparison of the overall O&M costs of the entire UWS (Fig. 8(d)) shows that both strategies would result in a relatively equal growth for O&M costs with an insignificant greater amount for strategy 2. More specifically, the variations of the O&M cost in different UWS components of strategy 1 are almost unchanged except for O&M cost increase in WTWs due to supplying additional raw for treatment. These

517 variations in strategy 2 are also unchanged except for a considerable increase for Subcatchment due to
 518 additional costs incurred for water recycling schemes.
 519

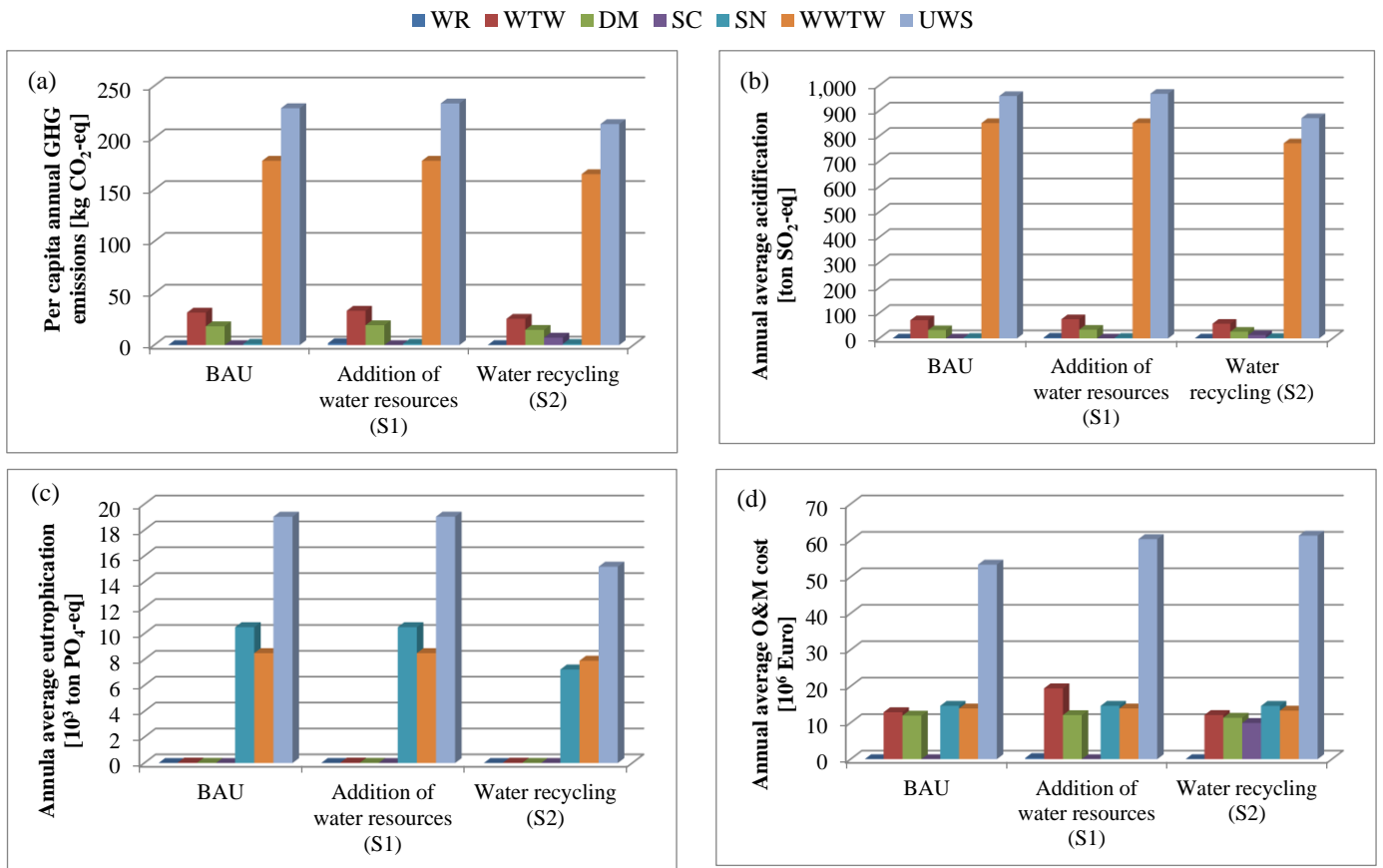

520 **Fig. 8.** Comparison of the UWS components for different strategies with respect to (a) per capita annual GHG emissions (b)
 521 annual average acidification (c) annual average eutrophication (d) annual average O&M cost
 522

523 Further analysis of the environmental impact categories can be carried out by comparing the annual
 524 variations of caused and avoided GHG emissions for the suggested strategies with the BAU (Fig. 9). It is
 525 evident that caused GHG emissions in all states are greater than avoided GHG emissions by one order of
 526 magnitude. Hence, the effect of avoided GHG emissions is almost negligible for decreasing the total caused
 527 GHG emissions in the UWS. After adding a new water resource in year 2020 (strategy 1), the caused GHG
 528 emissions have slightly increased although the avoided GHG emissions are unchanged compared to the
 529 BAU. However, strategy 2 will significantly mitigate the caused GHG emissions while reducing the
 530 avoided GHG emissions at the same rate. Due to the different orders of magnitude between the avoided and
 531 caused GHG emissions, consequently the net GHG emissions in strategy 2 will reduce significantly. The
 532 decline of the avoided GHG emissions can be attributed to the reduced wastewater /stormwater being
 533 conveyed to the WWTWs which are the main factor for the avoided GHG emissions (i.e. by-products of
 534 wastewater treatment).

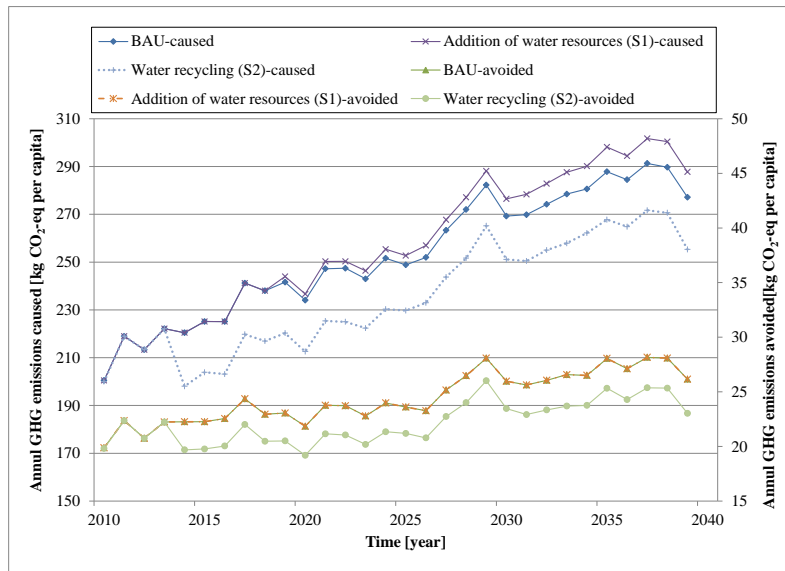
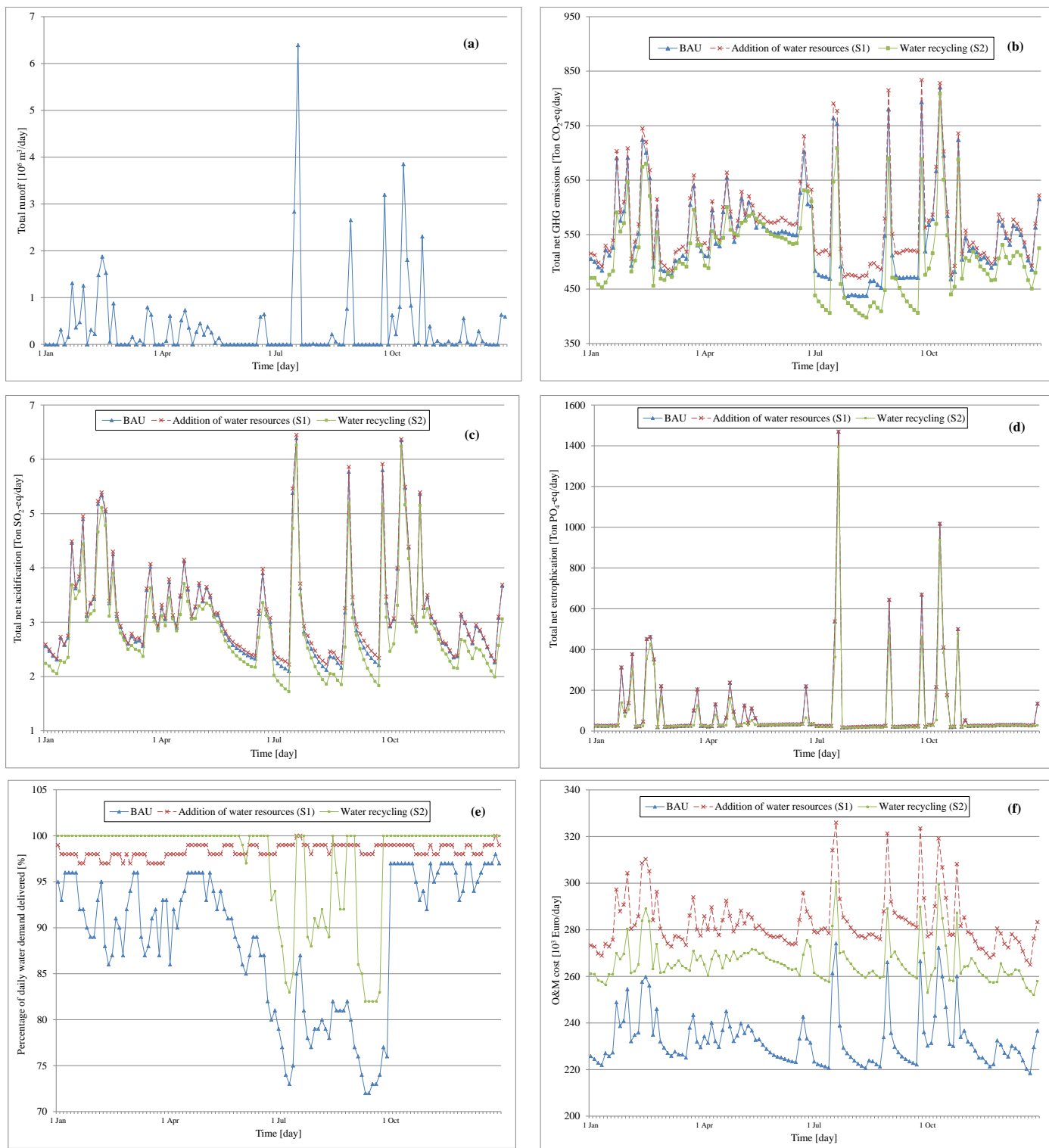

Fig. 9. Annual variations of caused and avoided GHG emissions for different strategies

In addition to overall and monthly variations of the metrics in the UWS components, daily analysis of the metrics can uncover some further details of the interaction caused by the intervention strategies. Hence, Fig. 10 shows a snapshot of daily variations for the abovementioned metrics during four months (i.e. January, April, July and October) of year 2038 when the delivered water demand and runoff flow are highly variable. As it can be seen, the variations of some metrics (i.e. GHG emissions, acidification, eutrophication and O&M cost) are mainly affected by runoff variations and directly proportional to runoff. These proportionate fluctuations are particularly evident for the variations of eutrophication which are especially a direct reflection of high daily runoff (compare Fig. 10(a) with 10(d)). This can be due to the contaminants washing off the urban surfaces and discharging into the receiving water bodies. This also confirms the above observation for the total eutrophication of the UWS. Consequently, strategy 1 has no effect on the eutrophication variations while strategy 2 can attenuate the peak values well when there are high daily runoff volumes due to saving of runoff in the storage recycling tanks. The eutrophication improvement for days with no rain is almost trivial compared to the rainy days. However, the impact of either of the two strategies on GHG emissions and acidifications are in opposition. More specifically, while strategy 2 improves daily GHG emissions and acidification, these metrics deteriorate in strategy 1. Furthermore, the rate of variations of these metrics over this period is independent from the daily runoff variations. This rate especially for strategy 1 is more affected by the percentage of water demand delivered according to Fig. 10(e). More specifically, for those days in which the percentage of water demand delivered in the BAU is low, strategy 1 provides more fresh water resulting in more energy consumption. Therefore, GHG emissions and acidification will increase considerably compared to other days. Moreover, increase in the O&M costs in both strategies compared to the BAU is completely independent from either water demand delivered or total daily runoff. The rate of this increase in strategy 1 is greater than strategy 2 mainly due to greater consumption of energy and chemicals. Also, it should be noted from Fig. 10(e) that

561 unmet water demand in the BAU can be almost compensated steadily over the entire period only by
 562 strategy 1 due to greater water supply.

563



564 **Fig. 10.** Daily variations of the metrics for different strategies for (a) runoff (b) net GHG emissions (c) net acidification (d) net
 565 eutrophication, (e) water demand delivered, and (f) O&M cost.

566

567 Finally note that a more comprehensive decision support framework and tool can be further developed by
568 linking the WaterMet² model to some decision support type methods (e.g. some Multi-Criteria Decision
569 Analysis). For instance, a typical decision support framework can be used to simulate and analyse a variety
570 of potential and complex intervention strategies by using WaterMet² and then rank them based on a number
571 of performance criteria supported by either WaterMet² or other tools. As a result, a limited number of high
572 ranked strategies can then be selected to be taken further to the next, detailed level of planning involving
573 physically based simulation models. Hence, this process will assist stakeholders (e.g. water companies) in
574 providing additional and detailed information and subsequently making more informed decisions.

575 **5. Conclusions**

576 The proposed methodology and associated software tool (WaterMet²) was developed and presented here
577 as a conceptual, mass balance based simulation model quantifying energy and other fluxes derived from the
578 underlying water flows for a long-term planning horizon of an integrated UWS. The new methodology
579 enables quantifying complex water-energy issues and associated impacts at different spatial and functional
580 scales by linking together various urban water system (UWS) components and elements at 4 different
581 spatial scales which, in turn, often results in complex water-energy feedback type loops being built and
582 evaluated. Furthermore, the main advantage of WaterMet² compared with the counterpart tools is in the
583 assessment of the metabolism based performance of the UWS. This enables WaterMet² to concurrently
584 quantify sustainability based metrics especially avoided and caused environmental impact categories (e.g.
585 GHG emissions, acidification and eutrophication potentials) of the UWS in addition to various water flows
586 and other business-as-usual impact categories (e.g. energy and cost). The WaterMet² methodology was
587 demonstrated for strategic-level planning of the UWS of a northern European city. An aggregated model of
588 the UWS was developed although the full capability of the model was not ideally demonstrated in this case
589 study, due to the lack of detailed data required.

590 As demonstrated in a real-life case study shown, the required conceptual model can be relatively easily
591 built and calibrated and then used for the long-term evaluation of different UWS configurations and
592 associated system loads, both existing and modified (i.e. following some interventions). Based on the
593 results obtained it can be concluded that the model can be used to effectively and efficiently quantify the
594 UWS performance across the full urban water cycle. The model is particularly useful when the purpose is
595 to measure impact of different configurations of the UWS on the long-term sustainability performance. For
596 instance, applying the water recycling schemes would result in the overall improvement of the
597 environmental impact categories although having a directly negative environmental impacts due to
598 electricity consumption. Also, the WWTWs are accounted for the major sources of GHG emissions and
599 acidification potential while causes of eutrophication potentials are shared mainly between WWTWs and
600 sewer networks. This is likely the main cause that 'water recycling' strategy outperforms 'addition of water

resources' strategy with respect to environmental impact categories as the former strategy can impact on both sides of the UWS (i.e. water supply and wastewater/stormwater).

It should also be noted that one of the purposes for developing WaterMet² was to apply it to the cities where no physically based models exist or building such models is difficult (e.g. due to lack of access to the detailed required input data). This issue could be particularly a great concern for the case studies in developing countries in which the challenges may be quite different in terms of performance indicators (e.g. focus only on conventional indicators). In these cases, WaterMet² can still be applied to overcome these shortages and address those performance indicators of interest.

6. Acknowledgements

The WaterMet² software tool was developed as part of the 'TRansition to Urban water Services of Tomorrow' (TRUST) project. The authors wish to acknowledge the European Commission for funding TRUST project in the 7th Framework Programme under Grant Agreement No. 265122. The authors also wish to thank Dr Mark Morley (Exeter University) for proofreading the paper and also thank the TRUST project partners in NTNU, Oslo VAV, SINTEFF and NTUA for their collaboration in WP33. The authors wish to thank the three anonymous reviewers for making constructive comments which substantially improved the quality of the paper.

7. References

- Alegre, H., Cabrera Jr, E., Hein, A., Brattebø, H.. Framework for Sustainability Assessment of UWCS and development of a self-assessment tool, Project Deliverable D31.1: TRUST report; 2012.
- Beck, M.B., Davis, C., Kenway, S.J., Porro, J., Matsui, S., Crawford, G., Hilger, H., Zhang, H. Sustainability in the Water Sector. Global Trends & Challenges in Water Science, Research and Management A compendium of hot topics and features from IWA Specialist Groups; 2012; 79-82.
- Behzadian K., Z. Kapelan, Oslo Case Study Report, TRansition to Urban water Services of Tomorrow (TRUST) project report; 2013
- Behzadian K., Z. Kapelan, G. Venkatesh, H. Brattebø, S. Sægrov, E. Rozos, C. Makropoulos, R. Ugarelli, J. Milina, and L. Hem. "Urban water system metabolism assessment using WaterMet² model", 12th International Conference on Computing and Control for the Water Industry, CCWI2013, Perugia, Italy, 2013.
- Behzadian K., Kapelan Z. Morley M. "Resilience-based performance assessment of water-recycling schemes in urban water systems", Water Distribution System Analysis, WDSA2014, Procedia Eng., Elsevier; 2014a; 89: 719-726.
- Behzadian K., Kapelan, Z., Venkatesh, G., Brattebø, H., and Sægrov, S.. "WaterMet²: a tool for integrated analysis of sustainability-based performance of urban water systems", Drink. Water Eng. Sci.; 2014b; 7, 63-72.
- Behzadian K., Z. Kapelan, G. Venkatesh, H. Brattebø, S. Sægrov, E. Rozos, C. Makropoulos,. "Quantitative UWS Performance Model: Watermet²", TRansition to Urban water Services of Tomorrow (TRUST) project report, 2014c.
- Change, Intergovernmental Panel on Climate. Climate change 2007: The physical science basis. Agenda 6.07: 333; 2007.
- Fagan JE, Reuter MA, Langford KJ. Dynamic performance metrics to assess sustainability and cost effectiveness of integrated urban water systems. Resour. Conserv. Recycl.; 2010, 54:719–36.
- Field, C. B., Barros, V. R., Mach, K., & Mastrandrea, M. Climate change 2014: impacts, adaptation, and vulnerability. Contribution of Working Group II to the Fifth Assessment Report of the Intergovernmental Panel on Climate Change; 2014.
- eWater, software products for integrated water cycle management: eWater Source, MUSIC by eWater and Urban Developer, Available at: <http://www.ewater.com.au/products/> 2014.
- IPCC. In: Eggleston, H.S., Buendia, L., Miwa, K., Ngara, T., Tanabe, K. (Eds.), 2006 IPCC Guidelines for National Greenhouse Gas Inventories. Institute for Global Environmental Strategies, Tokyo, Japan. Prepared by the National Greenhouse Gas Inventories Programme; 2006.

- 646 Kennedy, C., Cuddihy, J., Engel-Yan, J. The Changing Metabolism of Cities. *J. of Ind. Ecol.* 2007; 11(2) 43-59.
- 647 Kennedy, C., S. Pincetl, and P. Bunje. "The study of urban metabolism and its applications to urban planning and design." *Environmental pollution* 159.8, 2011; 1965-1973.
- 648 Loucks, D.P., Van Beek, E., Stedinger, J.R., Dijkman, J.P., Villars, M.T. *Water resour. syst. planin. and manag.: an introduction to methods, models and applications.* UNESCO; 2005.
- 649 Lundie S, Peters GM, Beavis P. Life cycle assessment for sustainable metropolitan water systems planning. *Environ. Sci. Technol.* 2004; 38(13):3465-73.
- 650 Lundin M, Morrison GM. A life cycle based procedure for development of environmental sustainability indicators for urban water systems. *Urban Water* 2002; 4(2):145-52.
- 651 Mackay, R., Last, E. SWITCH city water balance: a scoping model for integrated urban water management. *Reviews in Environ. Sci. and Bio/Technol.* 2010; 9(4) 291-296.
- 652 Maidment, D.R. *Handbook of hydrology.* McGraw-Hill Inc., New York; 1992.
- 653 Makropoulos, C.K., Natsis, K., Liu, S., Mittas, K., Butler, D. Decision support for sustainable option selection in integrated urban water management. *Environ. Model. & Softw.* 2008; 23(12) 1448-1460.
- 654 Memon, F.A., Butler, D., Han, W., Liu, S., Makropoulos, C., Avery, L.M., Pidou, M. Economic assessment tool for greywater recycling systems. *Proc. of the ICE-Eng. Sustain.* 2005; 158(3) 155-161.
- 655 Metcalf and Eddy, "Wastewater Engineering Treatment and Reuse", Fourth edition, McGraw Hill publisher, 2003; pages 155-163.
- 656 Mitchell, V.G., Diaper, C. Simulating the urban water and contaminant cycle. *Environ. Model. & Softw.* 2006; 21(1) 129-134.
- 657 Mitchell, V.G., Diaper, C. UVQ User Manual: (urban water balance and contaminant balance analysis tool), Version 1.2, CMIT Report No. 2005-282. CSIRO; 2010.
- 658 Mitchell, V.G., Mein, R.G., McMahon, T.A. Modelling the urban water cycle. *Environ. Model. & Softw.* 2001; 16(7) 615-629.
- 659 Morley M., K. Behzadian, Z. Kapelan, R. Ugarelli, Decision Support System for Metabolism-based Transition to Urban Water Systems of Tomorrow, IWA, IWA World Water Congress & Exhibition, Lisbon Portugal; 2014.
- 660 Moriasi, D.N., Arnold, J.G., Liew, M.W.V., Bingner, R.L., Harmel, R.D., Veith, T.L. Model evaluation guidelines for systematic quantification of accuracy in watershed simulations. *Transactions of the ASABE* 2007; 50(3) 885-900.
- 661 Mouri G, Oki T. Modeling the catchment-scale environmental impacts of wastewater treatment in an urban sewage system for CO₂ emission assessment. *Water Sci. Technol.* 2010; 62(4):972-83.
- 662 Nair, S., George, B., Malano, H. M., Arora, M., & Nawarathna, B. Water-energy-greenhouse gas nexus of urban water systems: Review of concepts, state-of-art and methods. *Resour., Conserv. and Recycl.* 2014; 89: 1-10.
- 663 Paton, F. L., G. C. Dandy, and H. R. Maier. Integrated framework for assessing urban water supply security of systems with non-traditional sources under climate change. *Environ. Model. & Softw.* 2014; 60, 302-319.
- 664 Rozos, E., Makropoulos, C. Source to tap urban water cycle modelling. *Environmental Modelling & Software* 2013; 41 139-150.
- 665 Rozos, E., Makropoulos, C., Butler, D. Design Robustness of Local Water-Recycling Schemes. *J. Water Resour. Plan. Manage.* 2010; 136(5) 531-538.
- 666 Savic, D., Bicik, J., Morley, M.S., Duncan, A., Kapelan, Z., Djordjević, S., Keedwell, E.C. Intelligent Urban Water Infrastructure Management. *J. of the Indian Inst. of Sci.* 2013; 93(2) 319-336.
- 667 Tukker, Arnold, and Bart Jansen, Environmental impacts of products: A detailed review of studies. *J. of Ind. Ecol.* 2006; 10.3: 159-182.
- 668 UNESCO. *Managing water under uncertainty and risk.* UN World Water Development Report Volume 1; 2012,
- 669 Valkering, Pieter, David Tabara, Patrik Wallman, and Astrid Offermans. "Modelling cultural and behavioural change in water management: an integrated, agent based, gaming approach." *Integ. Assess. J.*, 2009; 9(1) 19-46.
- 670 Venkatesh, G., Cost-benefit analysis – leakage reduction by rehabilitating old water pipelines: Case study of Oslo (Norway). *Urban Water Journal* 2012; 9(4) 277-286.
- 671 Venkatesh, G., Brattebø, H., Energy consumption, costs and environmental impacts for urban water cycle services: Case study of Oslo (Norway). *Energy* 2011; 36(2) 792-800.
- 672 Venkatesh, G., Sveinung Sægrov, and Helge Brattebø. Dynamic metabolism modelling of urban water services–Demonstrating effectiveness as a decision-support tool for Oslo, Norway. *Water res.* 2014; 61, 19-33.
- 673 Ward, S., Butler, D., Memon, F.A. Benchmarking energy consumption and CO₂ emissions from rainwater-harvesting systems: an improved method by proxy. *Water and Environ. J.* 2012; 26(2) 184-190.
- 674 Wolman, A. The Metabolism of Cities. *Sci Am* 1965; 213 179-190.
- 675 Zakkour PD, Gochin RJ, Lester JN. Evaluating sustainable energy strategies for a water utility. *Environ. Technol.* 2002; 23(7): 823-38.

704 **8. Appendix I: Notation**

705 Glossary of terms used in this paper is as follows:

Black water (wastewater): resulted from those water consumptions (e.g. toilet and kitchen sink) which need a centralised treatment and are discharged into sewer systems.

Green water: treated rainwater which can be used for non-potable demands.

Grey water: dilute wastewater mainly originating from domestic consumptions (i.e. hand basin, washing machine, shower, dish washer) which can be used for non-potable consumptions with specific level of treatment. If not recycled, grey water will be added to the black water stream.

Groundwater: part of precipitation which is infiltrated into the ground through pervious areas.

Storm water: part of precipitation which is converted to runoff and can be discharged into sewer system.

Potable water: high quality water which meets drinking water standards.

Reuse/recycling water: treated greywater or green water which can be used for water demands.

706

707 The following list of acronyms is used in this paper:

CSO: combined sewer overflow

DM: distribution main

DR: discharge route

GHG: greenhouse gas

GWR: greywater recycling

SC: subcatchment

(S/L)GWR: (subcatchment/local area) grey water recycling

SN: sewer network

SR: service reservoir

STO: storm tank overflow

(S/L)RWH: (subcatchment/local area) rainwater harvesting

TM: trunk main

RW: receiving water

RWH: rainwater harvesting

WR: water resource

WSC: water supply conduit

WTW: Water treatment works

WWTW: wastewater treatment works

UWS: urban water system

708

709