

Supplementary material relating to Warrington et al. (2019), Maternal and fetal genetic effects on birth weight and their relevance to cardio-metabolic risk factors. *Nature Genetics*, 51(5):804-814. Doi: 10.1038/s41588-019-0403-1. Epub 2019 May 1.

## Contents

### Supplementary Figures

Figure	Title	Page
Supplementary Figure 1	Flow diagram of the study design for the genome-wide association analysis of own birth weight.	4
Supplementary Figure 2	Flow diagram of the study design for the genome-wide association analysis of offspring birth weight.	5
Supplementary Figure 3	Miami plot and quantile-quantile (QQ) plots of the trans-ethnic meta-analysis of own birth weight (top panel) and offspring birth weight (bottom panel).	6
Supplementary Figure 4	Flow diagram describing the genome-wide significant SNPs and loci identified in both the GWAS of own and offspring birth weight.	7
Supplementary Figure 5	209 SNPs associated with birth weight ( $P < 6.6 \times 10^{-9}$ ) in the GWAS meta-analysis of own birth weight (a) or offspring birth weight (b) as a function of minor allele frequency.	8
Supplementary Figure 6	Path diagram of the structural equation model (SEM) used to estimate the maternal and fetal effect on birth weight.	9
Supplementary Figure 7	Structural equation model (SEM)-adjusted fetal and maternal effects estimated from the SEM for the 209 genome-wide significant SNPs that were identified in either the GWAS meta-analysis of own birth weight (146 independent SNPs; left panel) or offspring birth weight (72 independent SNPs; right panel).	10
Supplementary Figure 8	Comparison of structural equation model (SEM)-adjusted fetal and maternal effect sizes, estimated from the SEM, for the 209 genome-wide significant SNPs that were identified in either the meta-analysis of own or offspring birth weight.	11-17
Supplementary Figure 9	Comparison of the effect estimates (left panel) and standard errors (right panel) for the fetal effect (top panel) and maternal effect (bottom panel) from the full SEM (y-axis) and the weighted linear model (WLM; x-axis) for all 197 autosomal genome-wide significant SNPs that converged in the SEM.	18
Supplementary Figure 10	Global enrichment estimates across tissues sampled from the GTEx project.	19
Supplementary Figure 11	Summary of previously reported loci for fasting glucose and their effect on birth weight.	20
Supplementary Figure 12	Summary of previously reported loci for type two diabetes (T2D) and their effect on birth weight.	21
Supplementary Figure 13	Summary of previously reported loci for insulin secretion and their effect on birth weight.	22
Supplementary Figure 14	Summary of previously reported loci for insulin sensitivity and their effect on birth weight.	23

Supplementary Figure 15	Summary of previously reported loci for systolic blood pressure (SBP) and their effect on birth weight.	24
Supplementary Figure 16	Summary of previously reported loci for diastolic blood pressure (DBP) and their effect on birth weight.	25
Supplementary Figure 17	Possible explanations for the negative genetic correlation between birth weight and later life SBP.	26-27
Supplementary Figure 18	Flow diagram outlining the analysis pipeline to estimate the weighted linear model (WLM)-adjusted fetal and maternal effects on birth weight for each SNP in the genome.	28
Supplementary Figure 19	Boxplots of the bias in the maternal (top panel) or fetal (bottom panel) causal effect estimates from simulations with a negative correlation between the maternal and fetal genetic effects on the outcome.	65

### Supplementary Tables

Table	Title	Page
Supplementary Table 1	Description of studies contributing to trans-ancestry GWAS meta-analysis of own birth weight: ancestry group and country of origin, sample size, data collection methods, and birth weight summaries and exclusions.	29-32
Supplementary Table 2	Description of studies contributing to trans-ancestry GWAS meta-analysis of own birth weight: genotyping, quality control, pre-phasing, imputation, and association analysis.	33-36
Supplementary Table 3	Description of studies contributing to trans-ancestry GWAS meta-analysis of offspring birth weight: ancestry group and country of origin, sample size, data collection methods, and birth weight summaries and exclusions.	37-38
Supplementary Table 4	Description of studies contributing to trans-ancestry GWAS meta-analysis of offspring birth weight: genotyping, quality control, pre-phasing, imputation, and association analysis.	39-40
Supplementary Table 5	Summary statistics from the genome-wide association meta-analyses of own and offspring birth weight with the results of the 209 genome-wide significant SNPs from 190 signals ( $P < 6.6 \times 10^{-9}$ ) presented in table (a) and the additional 96 SNPs with suggestive significance ( $6.6 \times 10^{-9} < P < 5 \times 10^{-8}$ ) presented in table (b).	See excel file
Supplementary Table 6	Results from the comparison between the structural equation model (SEM) and the conditional linear regression analysis in 18,873 mother/offspring pairs from ALSPAC (N=4,309), EFSOCH (N=630) and MoBa-HARVEST (N=13,934).	See excel file
Supplementary Table 7	Results from LD-SEG <sup>1</sup> using epigenetic signatures defined by the Roadmap Epigenomics project.	See excel file
Supplementary Table 8	Results from gene-set enrichment analysis in MAGENTA <sup>1</sup> for the GWAS of own birth weight.	See excel file
Supplementary Table 9	Results from gene-set enrichment analysis in MAGENTA <sup>1</sup> for the GWAS of offspring birth weight.	See excel file

Supplementary Table 10	Genetic correlation between birth weight and a range of traits and diseases, estimated using LD score regression <sup>1</sup> in LD Hub <sup>2*</sup> .	See excel file
Supplementary Table 11	Summary statistics from genome-wide association study of gestational duration (in weeks; N=43,568), using maternal genotype and linear regression, for each of 209 birth weight associated SNPs (a) or the SNPs known to be associated with gestational duration (b) from Zhang et al. 2017 ( <a href="http://www.nejm.org/doi/full/10.1056/NEJMoa1612665">http://www.nejm.org/doi/full/10.1056/NEJMoa1612665</a> ).	See excel file
Supplementary Table 12	Results from linear regression analyses assessing the association in 13,206 mother-child pairs between seven birth weight-associated SNPs and gestational duration (a), gestational duration adjusted for birth weight (b) or birth weight (c).	See excel file
Supplementary Table 13	Phenotypes reported in NHGRI for our 209 genome-wide significant SNPs, and phenome-wide association study (PheWAS) traits in the UK Biobank with P-value < 5x10 <sup>-8</sup> .	See excel file
Supplementary Table 14	Summary of the studies and effect sizes used to define the genotype-exposure component of the Mendelian Randomization analysis.	See excel file
Supplementary Table 15	Results of Mendelian randomization analyses testing for causal associations between height, glycaemic traits or blood pressure and birth weight.	See excel file
Supplementary Table 16	Association between offspring birth weight and maternal non-transmitted allele score, maternal transmitted (or shared) allele score or paternal transmitted allele score for adult height, glycaemic traits and blood pressure in 4,962 mother-child pairs from the ALSPAC study.	41
Supplementary Table 17	The proportion of the birth weight-adult phenotype covariance that is attributable to genotyped SNPs in UK Biobank estimated using BOLT-REML.	See excel file
Supplementary Table 18	Association between maternal, paternal or offspring allelic scores of birth weight (a) or systolic blood pressure (b) associated SNPs and offspring systolic blood pressure (SBP), without and with adjustment for offspring SNPs, in 3,886 mother-offspring pairs and 1,749 father-offspring pairs from the UK Biobank.	42-43
Supplementary Table 19	Results from the structural equation model excluding EGG cohorts from the meta-analysis of own birth weight that contributed to both the original meta-analyses of own and offspring birth weight.	See excel file

<b>Supplementary Note 1: Supplementary Methods</b>	44-64
<b>Supplementary Note 2: Study limitations</b>	66-67
<b>References</b>	68-69
<b>Supplementary Note 3: Early Growth Genetics (EGG) consortium members, including affiliations</b>	70-76
<b>Supplementary Note 4: Study acknowledgements</b>	77-81
<b>Supplementary Note 5: Study funding statements</b>	82-89
<b>Supplementary Note 6: Author funding statements</b>	90-92



**Supplementary Figures:**

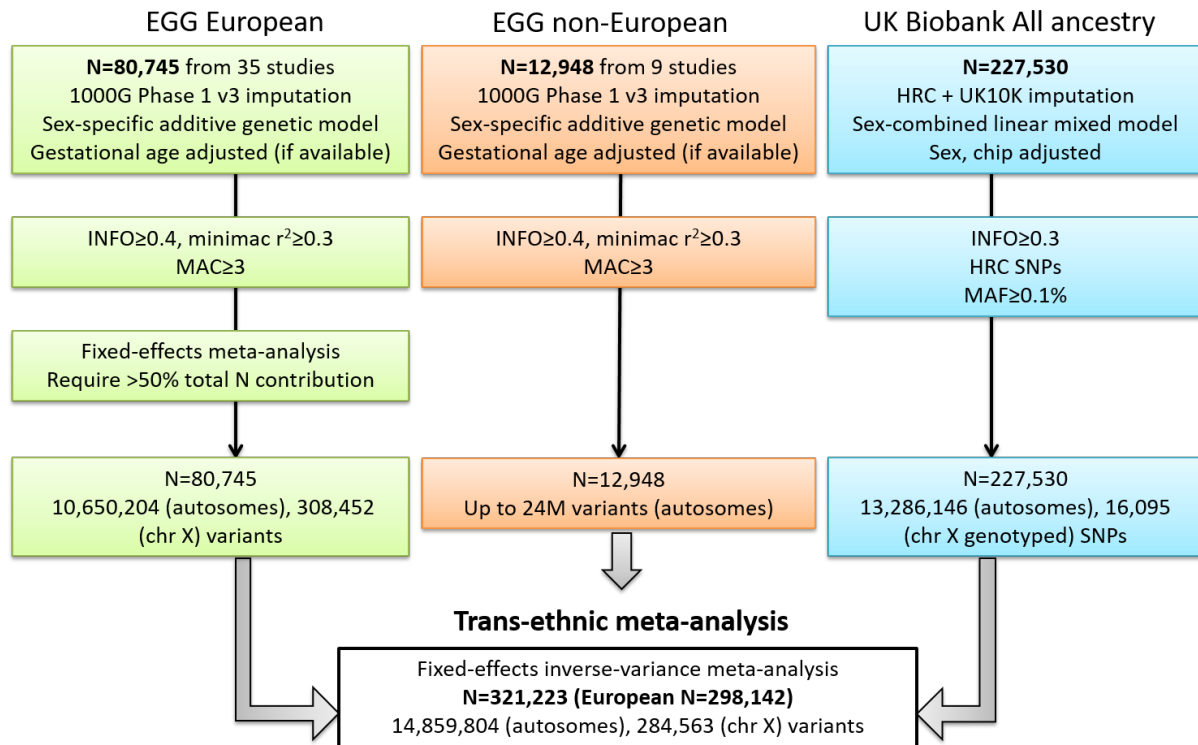

**Supplementary Figure 1**

Flow diagram of the study design for the genome-wide association analysis of own birth weight.

MAC, minor allele count; MAF, minor allele frequency; chr, chromosome.

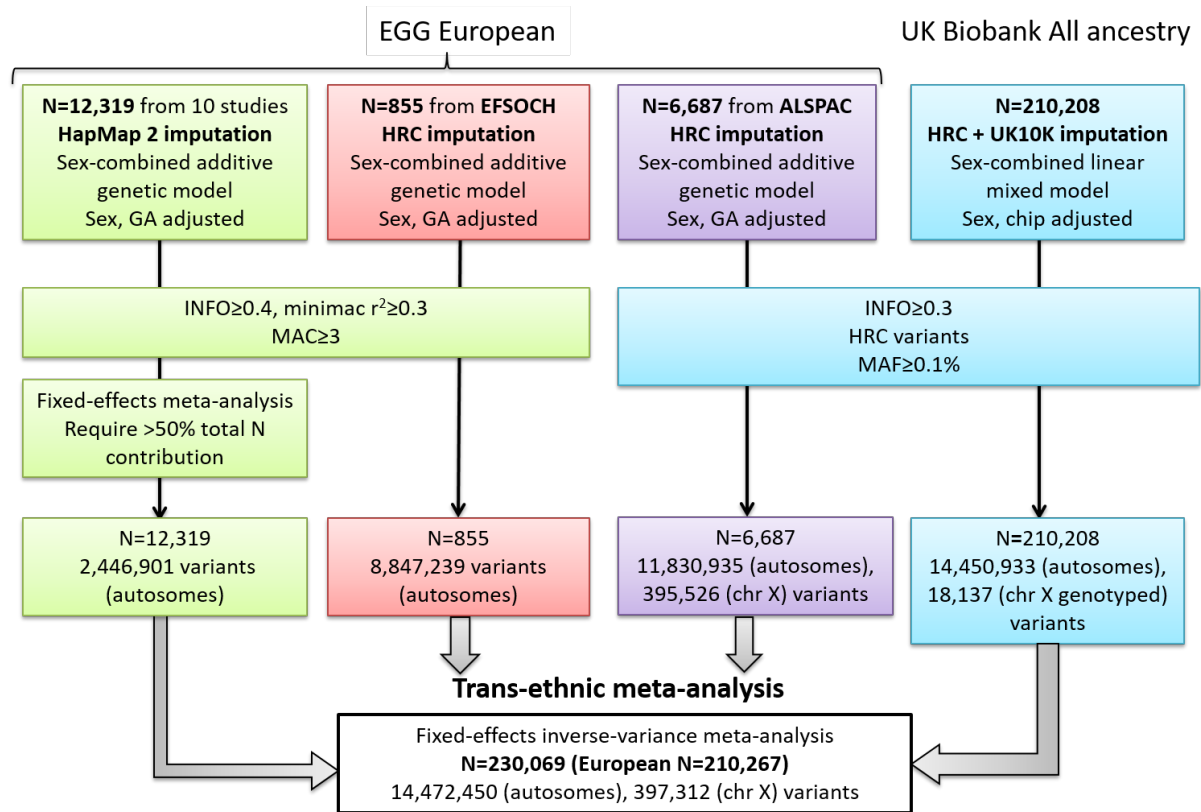

**Supplementary Figure 2**

Flow diagram of the study design for the genome-wide association analysis of offspring birth weight.

GA, gestational age; MAC, minor allele count; MAF, minor allele frequency; chr, chromosome.

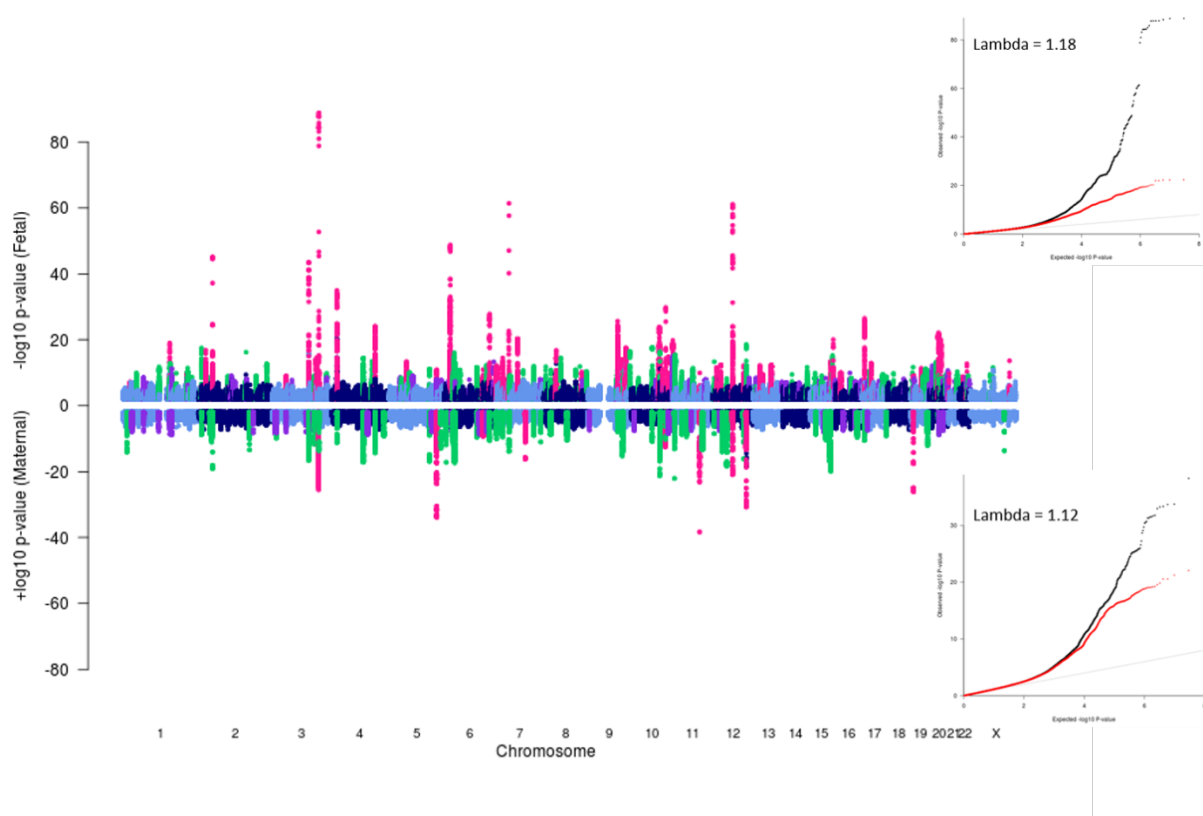

### Supplementary Figure 3

Miami plot and quantile-quantile (QQ) plots of the trans-ethnic meta-analysis of own birth weight (top panel; N=321,223) and offspring birth weight (bottom panel; N=230,069).

The two-sided association P-value (on the  $-\log_{10}$  scale for the results of own birth weight and  $\log_{10}$  scale for the results of offspring birth weight) obtained from the inverse-variance-weighted fixed-effects meta-analysis for each of the SNPs (y-axis) was plotted against the genomic position (NCBI Build 37; x-axis). Association signals that reached genome-wide significance ( $P < 6.6 \times 10^{-9}$ ) are shown in green if they are novel and pink if they have been previously reported. Association signals with  $6.6 \times 10^{-9} < P < 5 \times 10^{-8}$  are shown in purple. In the QQ plots, the black dots represent observed P-values and the grey line represents expected P-values under the null distribution. The red dots represent observed P-values after excluding the previously identified signals (Horikoshi et al. 2016, <https://www.nature.com/articles/nature19806>; Beaumont et al. 2018, <https://academic.oup.com/hmg/article/27/4/742/4788598>).

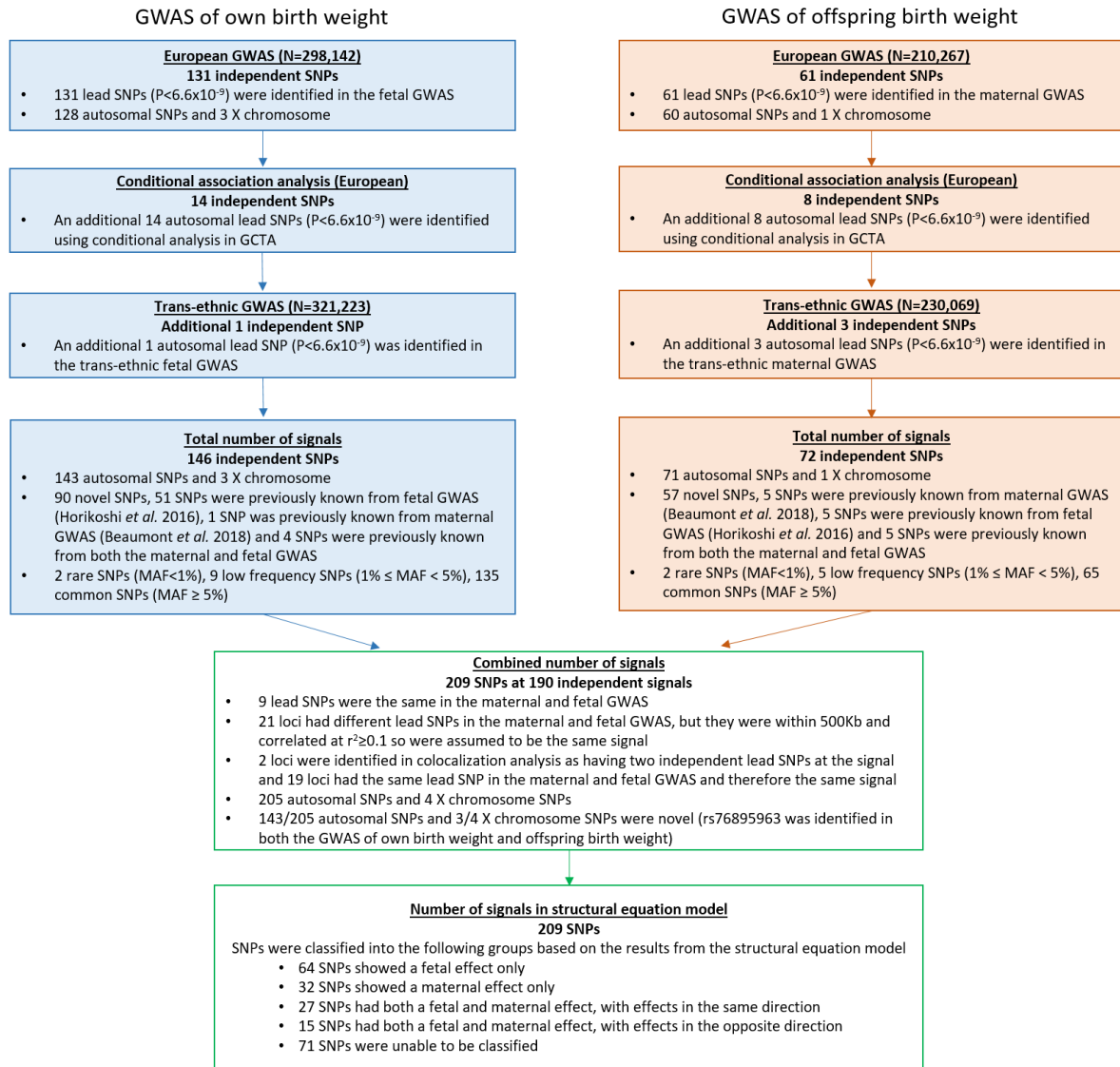

**Supplementary Figure 4**

Flow diagram describing the genome-wide significant SNPs and loci identified in both the GWAS of own and offspring birth weight.



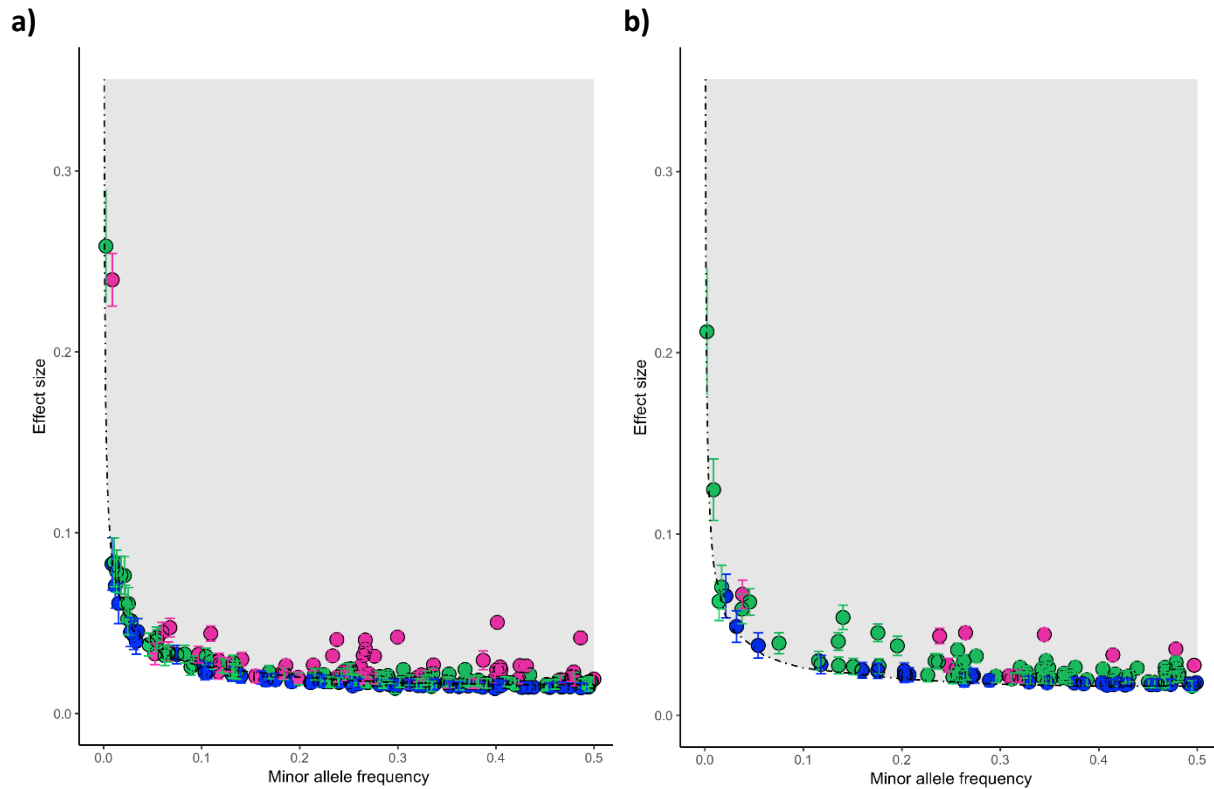

**Supplementary Figure 5**

The effect of the 209 SNPs associated with birth weight ( $P < 6.6 \times 10^{-9}$ ) in the GWAS inverse-variance-weighted fixed-effects meta-analysis of own birth weight (a;  $N=321,223$ ) or offspring birth weight (b;  $N=230,069$ ) as a function of minor allele frequency.

The effect of the 146 independent SNPs from the GWAS of own birth weight (a) and 72 independent SNPs from the GWAS of offspring birth weight (b) (absolute value of  $\beta$  with 95% confidence interval, y-axis) is given as a function of the minor allele frequency (x-axis) for the known (pink) or novel (green) birth weight associated loci from the meta-analyses. The 96 SNPs with  $6.6 \times 10^{-9} < P < 5 \times 10^{-8}$  are presented in blue. Error bars represent the standard error of the effect size. The dashed line indicates 80% power to detect association at genome-wide levels of significance for the sample size in the meta-analysis (assuming a linear regression model was used for the analysis).

a)

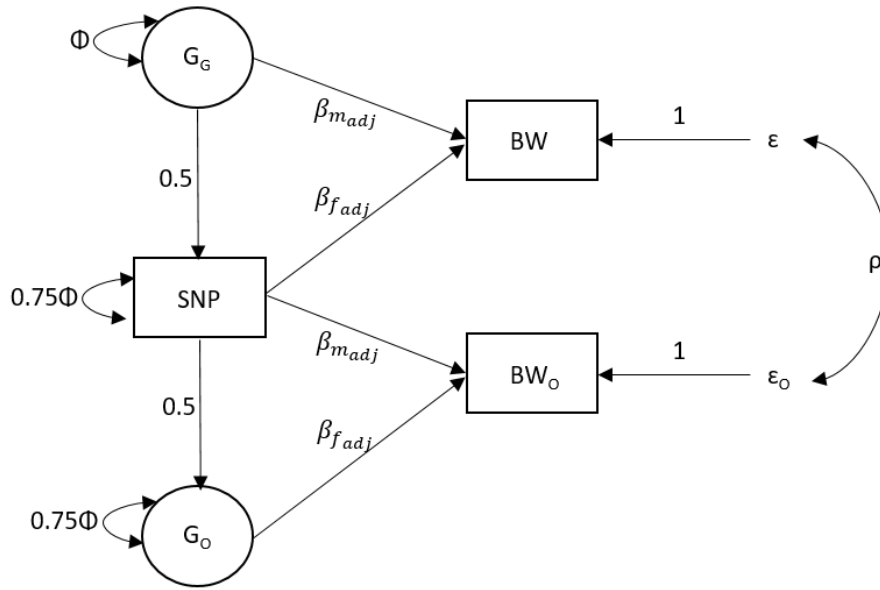

b)

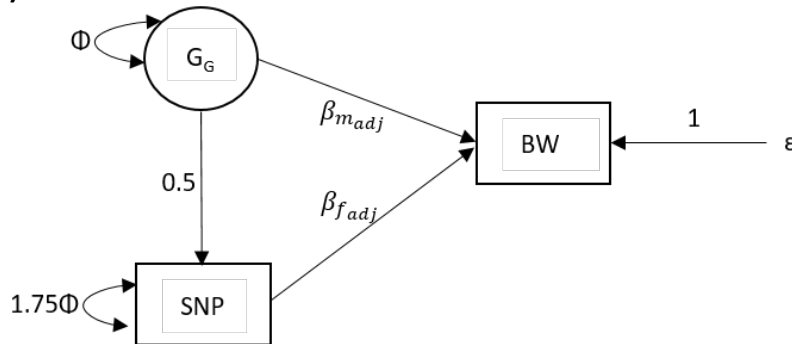

**Supplementary Figure 6**

Path diagram of the structural equation model (SEM) used to estimate the maternal and fetal effect on birth weight.

The observed variables, displayed in boxes in the path diagram, represent the birth weight of the individual (BW), the birth weight of their offspring ( $BW_O$ ) and the genotype of the individual (SNP). The two variables in circles represent the unobserved latent genotypes of the individual's mother ( $G_G$ ) and their offspring ( $G_O$ ). The  $\hat{\beta}_{f\_adj}$  and  $\hat{\beta}_{m\_adj}$  path coefficients refer respectively to the SEM-adjusted fetal and maternal effects on birth weight. The residual error terms for the birth weight of the individual and their offspring are represented by  $\epsilon$  and  $\epsilon_O$  respectively.

**a)** for autosomal SNPs and the X chromosome in females: The total variance of the latent genotypes is set to  $\Phi$ , the variance of the observed SNP (i.e.  $\text{var}(G_G) = \Phi$ ;  $\text{var}(SNP) = 0.5^2\Phi + 0.75\Phi$ ;  $\text{var}(G_O) = 0.5^2\Phi + 0.75\Phi$ ). The covariance between residual genetic and environmental sources of variation is given by  $\rho$ .

**b)** for X chromosome SNPs in males: The total variance of the latent genotype is set to  $\Phi$ , the variance of the observed SNP in females (i.e.  $\text{var}(G_G) = \Phi$ ), whereas the variance of the observed genotype in males is set to  $2\Phi$  (i.e.  $\text{var}(SNP) = 0.5^2\Phi + 1.75\Phi = 2\Phi$ ). Note that male individuals in UKBB do not report the birth weight of their offspring.

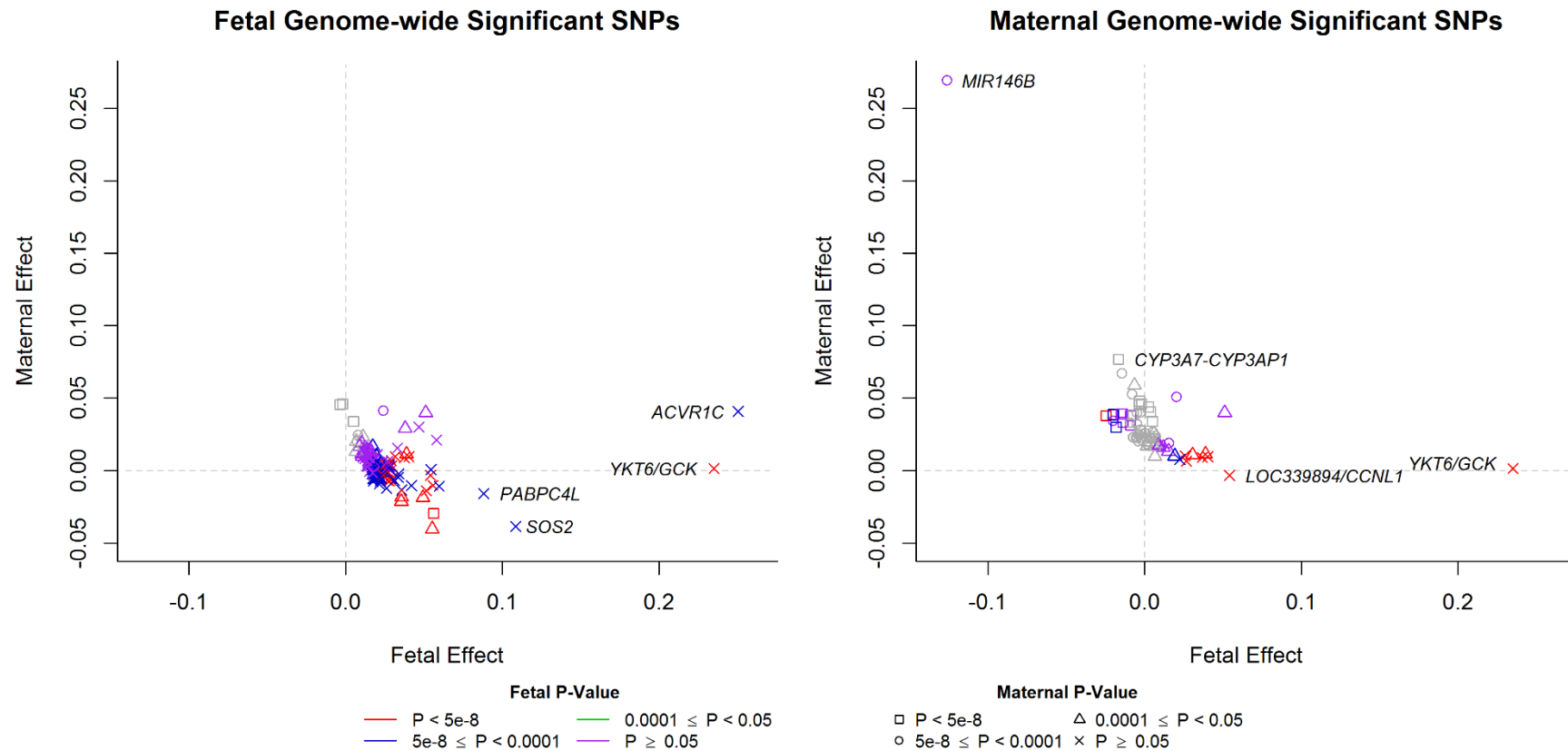

### Supplementary Figure 7

Structural equation model (SEM)-adjusted fetal and maternal effects estimated from the SEM for the 209 genome-wide significant SNPs that were identified in either the GWAS meta-analysis of own birth weight (146 independent SNPs; left panel) or offspring birth weight (72 independent SNPs; right panel).

The SEM included 85,518 individuals from the UK Biobank with both their own and offspring's birth weight, 178,980 and 93,842 individuals from the UK Biobank and the EGG consortium with only their own birth weight or offspring's birth weight respectively. The colour of each point indicates the SEM-adjusted fetal effect on own birth weight association P-value and the shape of each point indicates the SEM-adjusted maternal effect on offspring birth weight association P-value. P-values for the fetal and maternal effect were calculated using a two-sided Wald test. SNPs are aligned to the birth weight increasing allele from the GWAS. SNPs with large estimated SEM-adjusted maternal or fetal effects are labelled with the name of the closest gene.

(a)



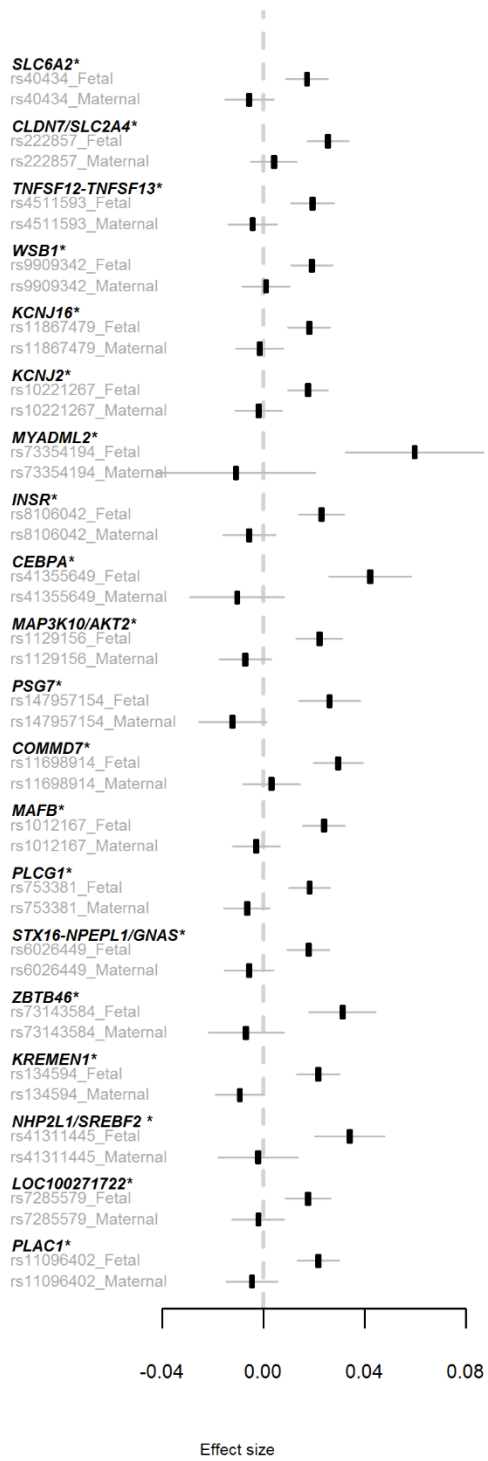

(b)

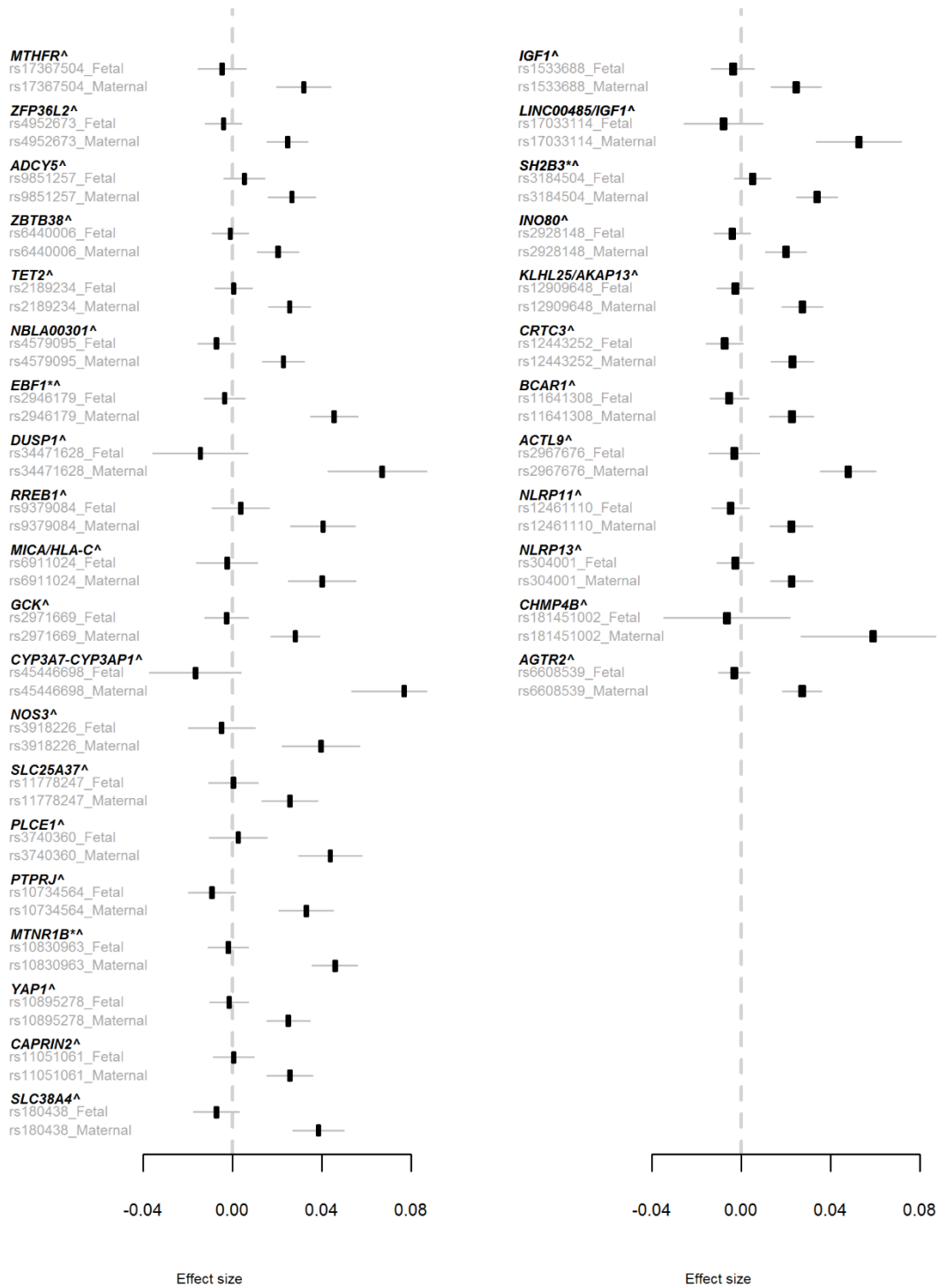

(c)

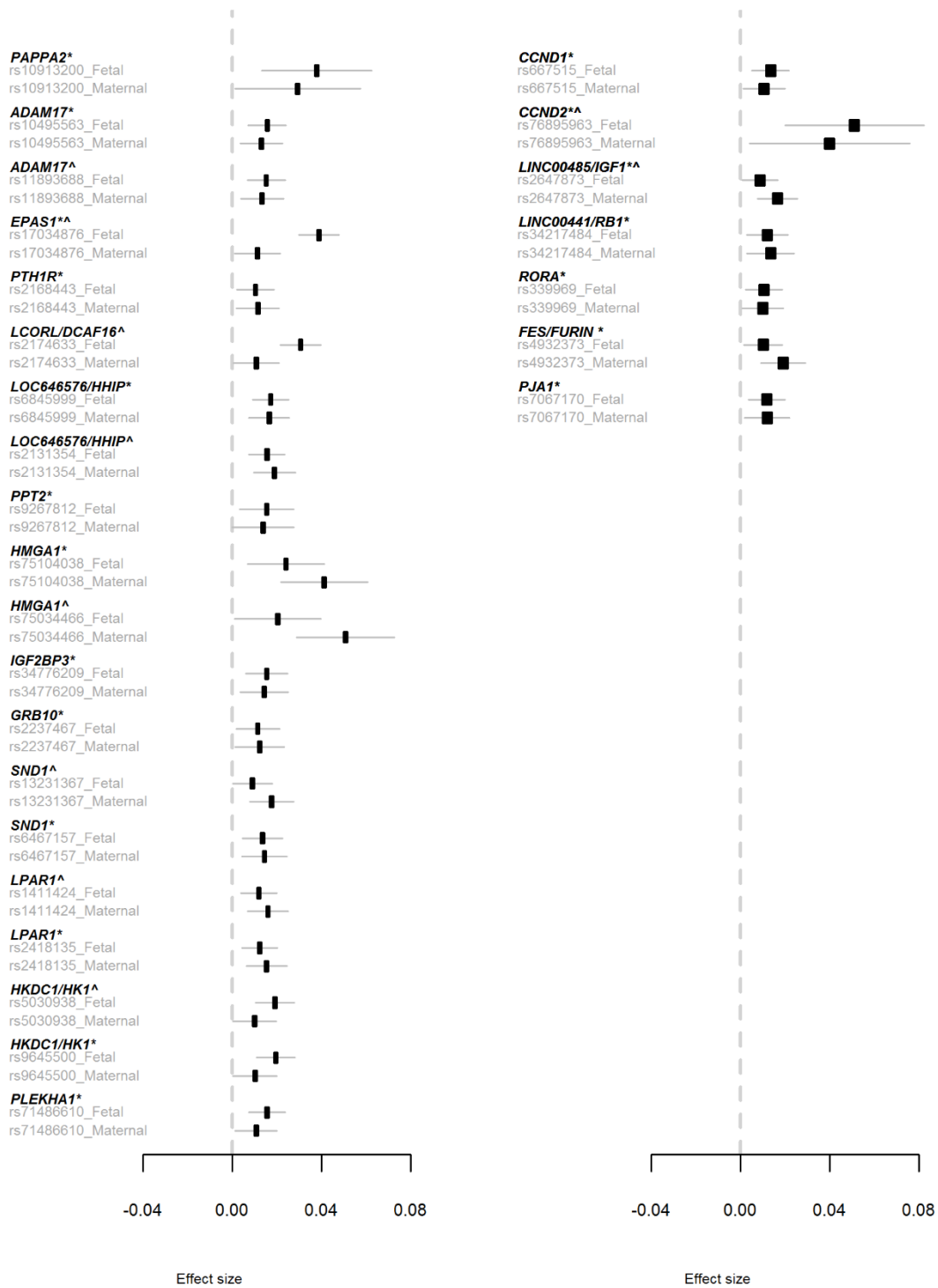

(d)

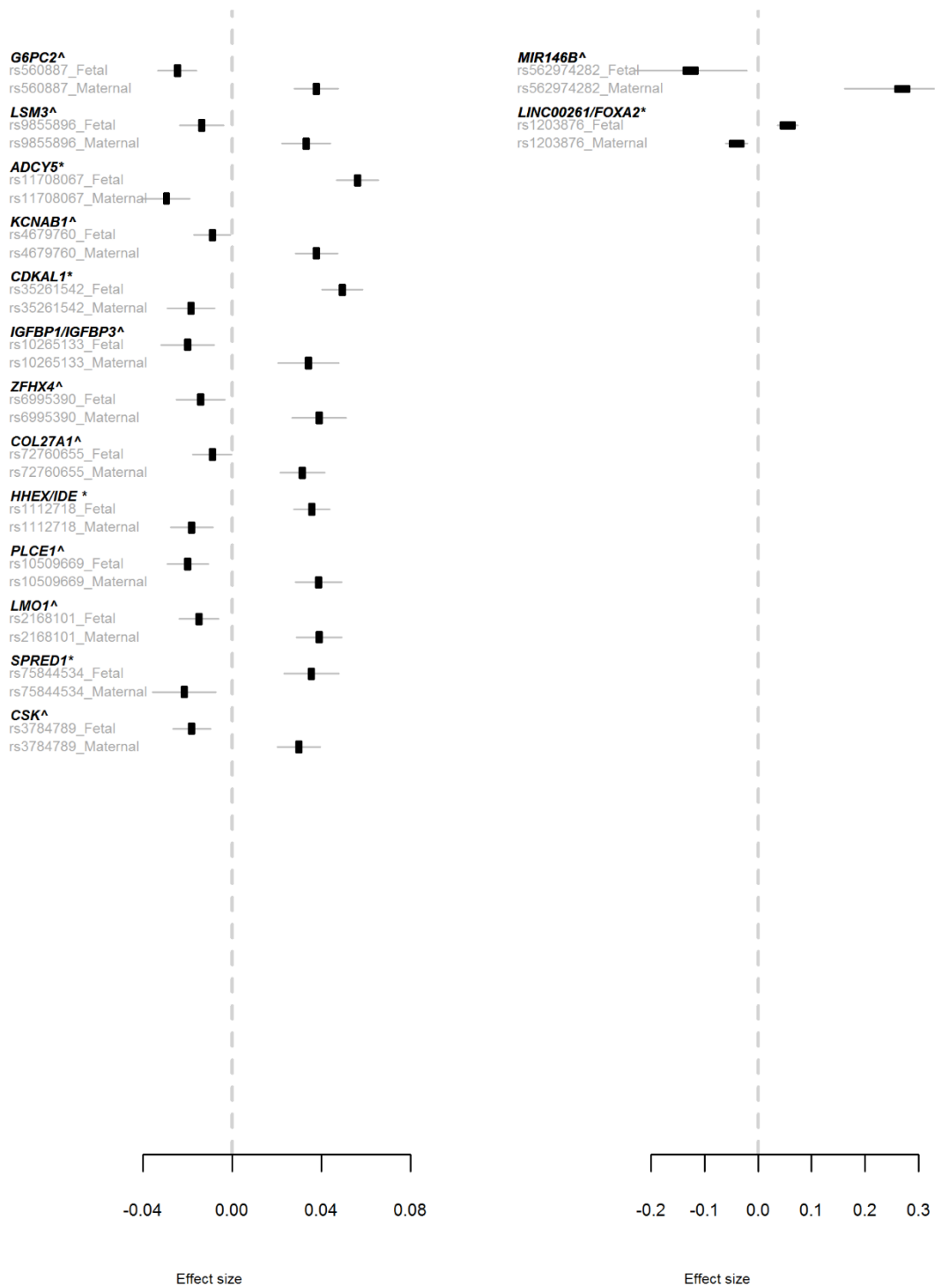



(e)

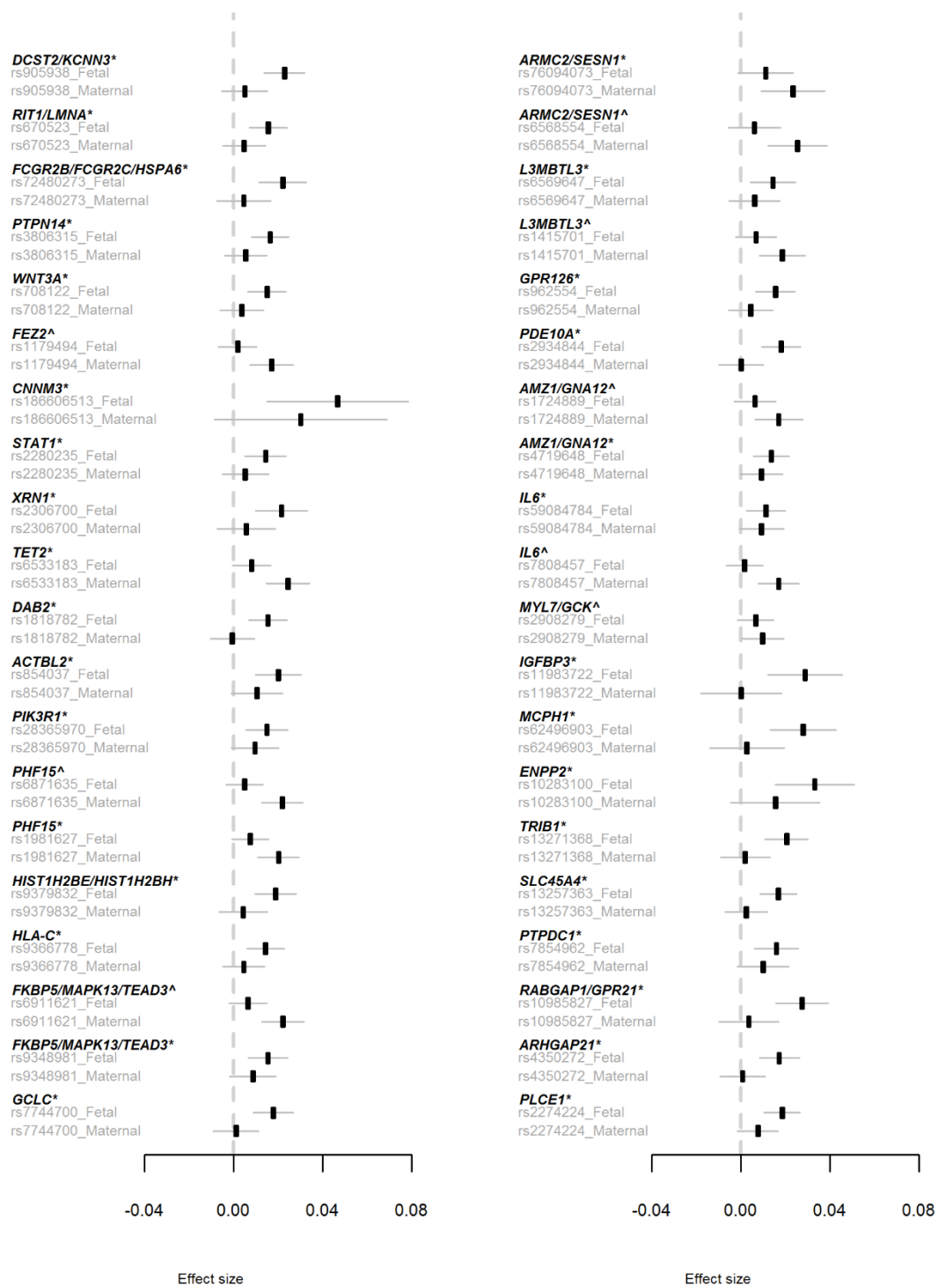

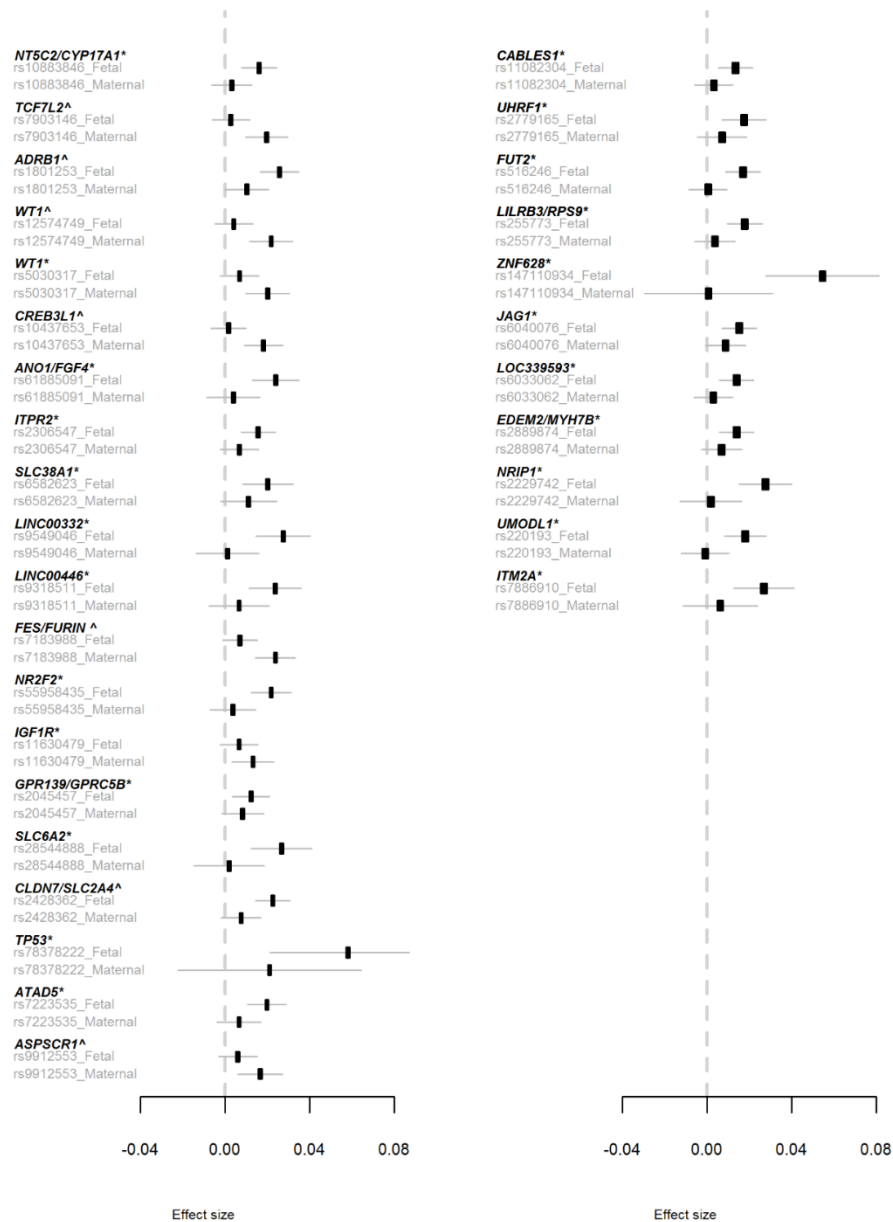

### Supplementary Figure 8

Comparison of structural equation model (SEM)-adjusted fetal and maternal effect sizes for the 209 genome-wide significant SNPs that were identified in the meta-analysis of own or offspring birth weight.

The SEM included 85,518 individuals from the UK Biobank with both their own and offspring's birth weight, 178,980 and 93,842 individuals from the UK Biobank and the EGG consortium with only their own birth weight or offspring's birth weight respectively. The SNPs in panel (a) were categorized, based on the SEM results, as having only a fetal effect (N=64 SNPs), panel (b) have only a maternal effect (N=32 SNPs), panel (c) have both a maternal and fetal effect which are in the same direction (N=27 SNPs), panel (d) have both a maternal and fetal effect in opposite directions (N=15 SNPs) and panel (e) were unclassified (N=71 SNPs). Within each panel, the SNPs were ordered by chromosome and position. Each SNP is aligned to the birth weight increasing allele from the meta-analysis that it was identified in (i.e SNPs from the GWAS of own birth weight are aligned to the allele that increases own birth weight). The effect sizes shown (with 95% CI) are: 'lead SNP rs number'\_Fetal, SEM-adjusted allelic effect on own birth weight; 'lead SNP rs number'\_Maternal, SEM-adjusted allelic effect on offspring birth weight. A \* after the signal name indicates SNPs that were identified in the GWAS of own birth weight, ^ from the GWAS of offspring and \*^ indicates it was identified in both GWAS.

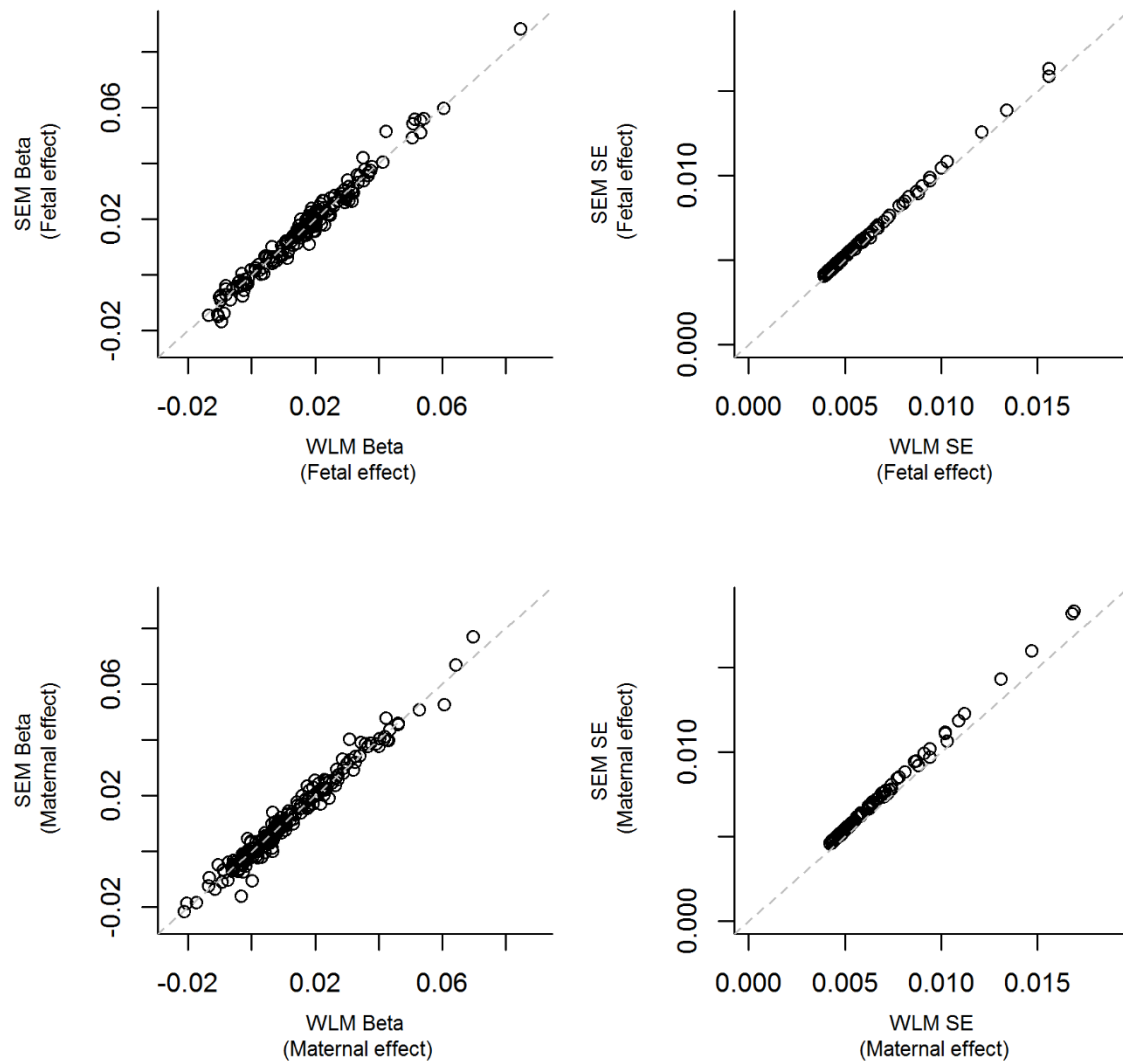

**Supplementary Figure 9**

Comparison of the effect estimates (left panel) and standard errors (right panel) for the fetal effect (top panel) and maternal effect (bottom panel) from the full SEM (y-axis) and the weighted linear model (WLM; x-axis) for all 197 autosomal genome-wide significant SNPs that converged in the SEM.

The SEM included 85,518 individuals from the UK Biobank with both their own and offspring's birth weight, 178,980 and 93,842 individuals from the UK Biobank and the EGG consortium with only their own birth weight or offspring's birth weight respectively. The WLM included 101,541 individuals from the UK Biobank with both their own and offspring's birth weight, 195,815 and 108,707 individuals from the UK Biobank and the EGG consortium with only their own birth weight or offspring's birth weight respectively. All SNPs are aligned to the birth weight increasing allele from the meta-analysis.

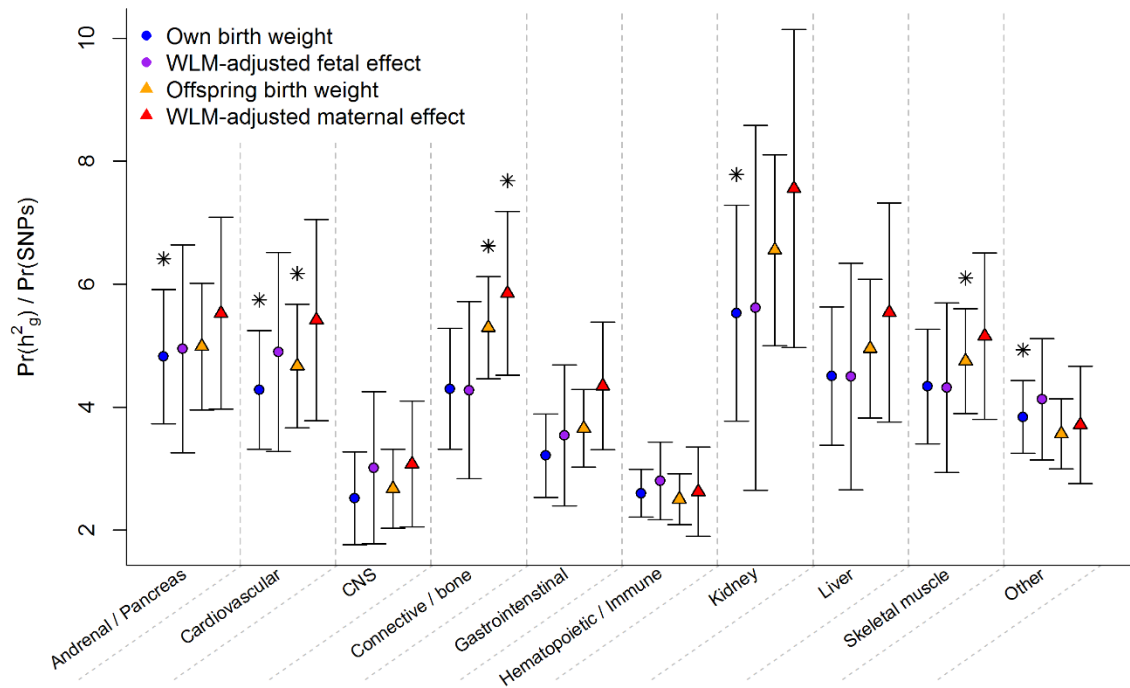

### Supplementary Figure 10

Global enrichment estimates across tissues sampled from the GTEx project.

The enrichment of each cell type group (x-axis) is defined to be the proportion of SNP heritability in the category divided by the proportion of SNPs in that category ( $\text{Pr}(h_g^2) / \text{Pr}(\text{SNP})$ ; y-axis), estimated using LD-SEG (Finucane et al. 2018, <https://www.nature.com/articles/s41588-018-0081-4>). Each point is the estimate of enrichment with corresponding 95% confidence interval (calculated using the jackknife standard errors). An asterisk indicates significance at  $P < 0.05$  after Bonferroni correction for the 40 hypotheses tested using the P-value for the coefficient corresponding to the annotation (P-values for those asterisks are: Adrenal/Pancreas, Own birth weight= $4.4 \times 10^{-4}$ ; Cardiovascular, Own birth weight= $1.9 \times 10^{-4}$ ; Cardiovascular, Offspring birth weight= $1.7 \times 10^{-4}$ ; Connective/Bone, Offspring birth weight= $5.4 \times 10^{-8}$ ; Connective/Bone, WLM-adjusted maternal effect= $6.7 \times 10^{-4}$ ; Kidney, Own birth weight= $1.1 \times 10^{-3}$ ; Skeletal muscle, Offspring birth weight= $8.6 \times 10^{-4}$ ; Other, Own birth weight= $5.9 \times 10^{-6}$ ). The blue points were estimated using the summary statistics from the GWAS of own birth weight ("Own birth weight";  $N=298,142$ ), the purple points using the summary statistics from the GWAS using the weighted linear model (WLM) to estimate the fetal effect on own birth weight ("WLM-adjusted fetal effect";  $N=406,063$  with their own and/or their offspring's birth weight), the orange triangles using the GWAS of offspring birth weight ("Offspring birth weight";  $N=210,267$ ), and the red triangles the WLM for the maternal effect on offspring birth weight ("WLM-adjusted maternal effect";  $N=406,063$  with their own and/or their offspring's birth weight). CNS, central nervous system.

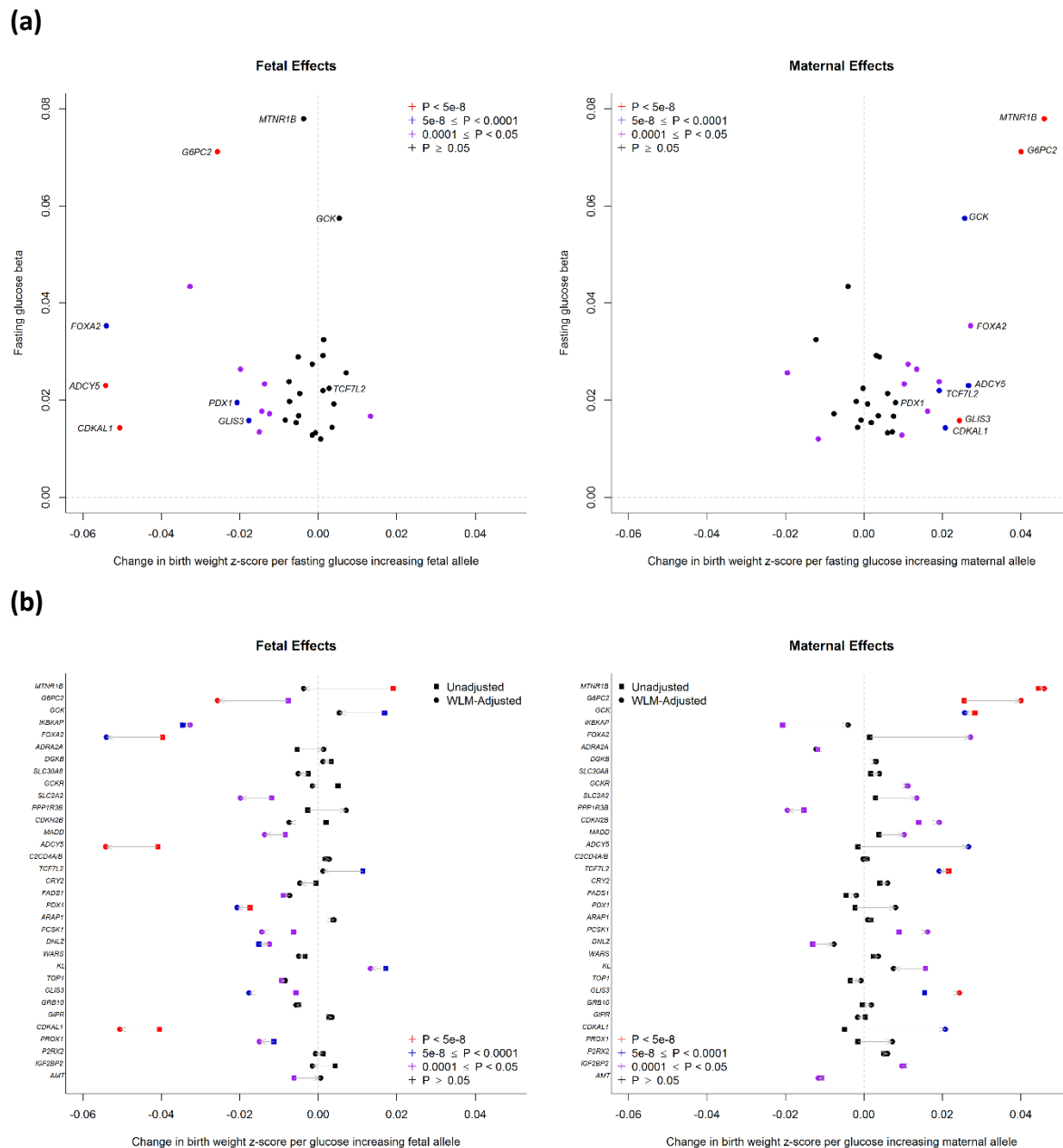

### Supplementary Figure 11

Summary of previously reported loci for fasting glucose and their effect on birth weight.

(a): Effect size (y axis) of the 33 previously reported SNPs for fasting glucose plotted against the effect on birth weight (x axis) from the weighted linear model (WLM)-adjusted fetal effect on own birth weight in the left plot and the WLM-adjusted maternal effect on offspring birth weight in the right plot. The colour of each dot indicates the birth weight association P-value, which were calculated using a two-sided Wald test. (b): effect sizes on birth weight (x-axis) for the 33 known fasting glucose SNPs (y-axis) in the GWAS meta-analysis (squares) for own birth weight (left plot) and offspring birth weight (right plot). The circles in the left plot represent the WLM-adjusted fetal effect on own birth weight, and in the right plot they represent the WLM-adjusted maternal effect on offspring birth weight. The colour of each point indicates the birth weight association P-value, which were calculated using a two-sided Wald test. The arrows indicate the change in the effect estimate after adjustment. Details of the SNPs are provided in Supplementary Table 14.

(a)

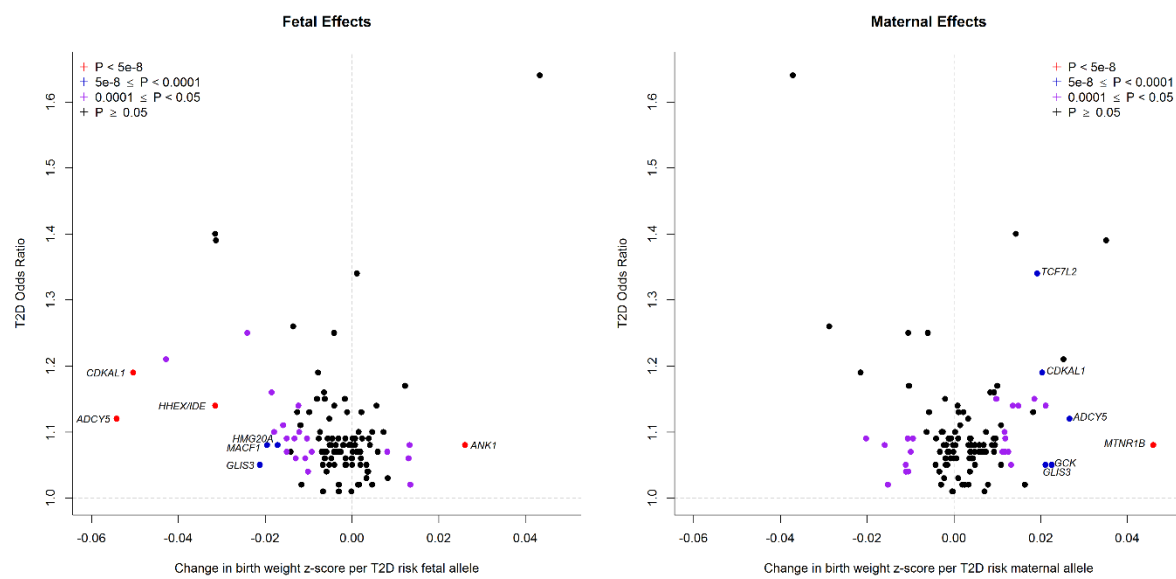

(b)

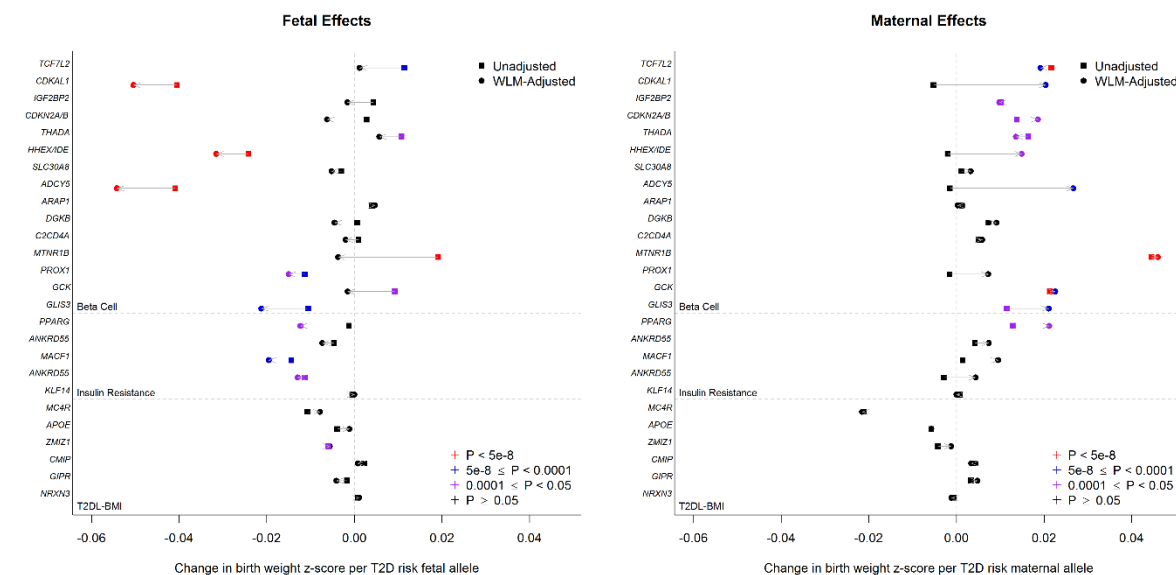

### Supplementary Figure 12

Summary of previously reported loci for type two diabetes (T2D) and their effect on birth weight.

(a): Effect size (y axis) of the 127 previously reported SNPs for T2D (Scott et al. 2017, <http://diabetes.diabetesjournals.org/content/early/2017/05/25/db16-1253>) plotted against the effect on birth weight (x axis) from the weighted linear model (WLM)-adjusted fetal effect on own birth weight in the left plot and the WLM-adjusted maternal effect on offspring birth weight in the right plot. The colour of each dot indicates the birth weight association P-value, which were calculated using a two-sided Wald test. (b): effect sizes on birth weight (x axis) for the subset of 26 known T2D SNPs which have been categorized by their function (y axis; Scott et al. 2017, <http://diabetes.diabetesjournals.org/content/early/2017/05/25/db16-1253>) in the GWAS meta-analysis (squares) for own birth weight (left plot) and offspring birth weight (right plot). The circles in the left plot represent the WLM-adjusted fetal effect on own birth weight, and in the right plot they represent the WLM-adjusted maternal effect on offspring birth weight. The colour of each point indicates the birth weight association P-value, which were calculated using a two-sided Wald test. The arrows indicate the change in the effect estimate after adjustment.

(a)

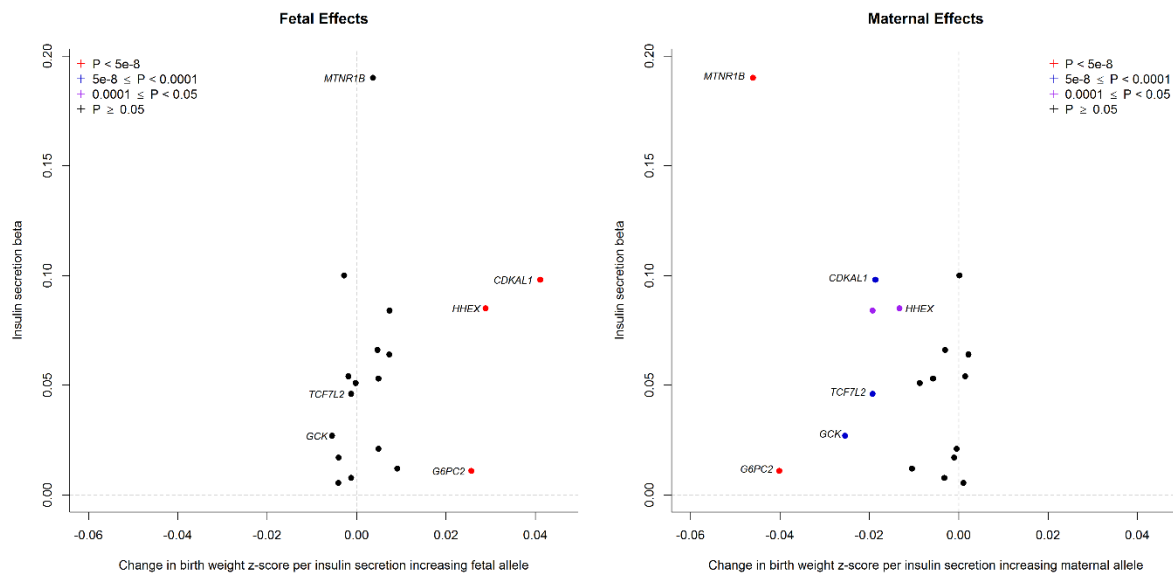

(b)

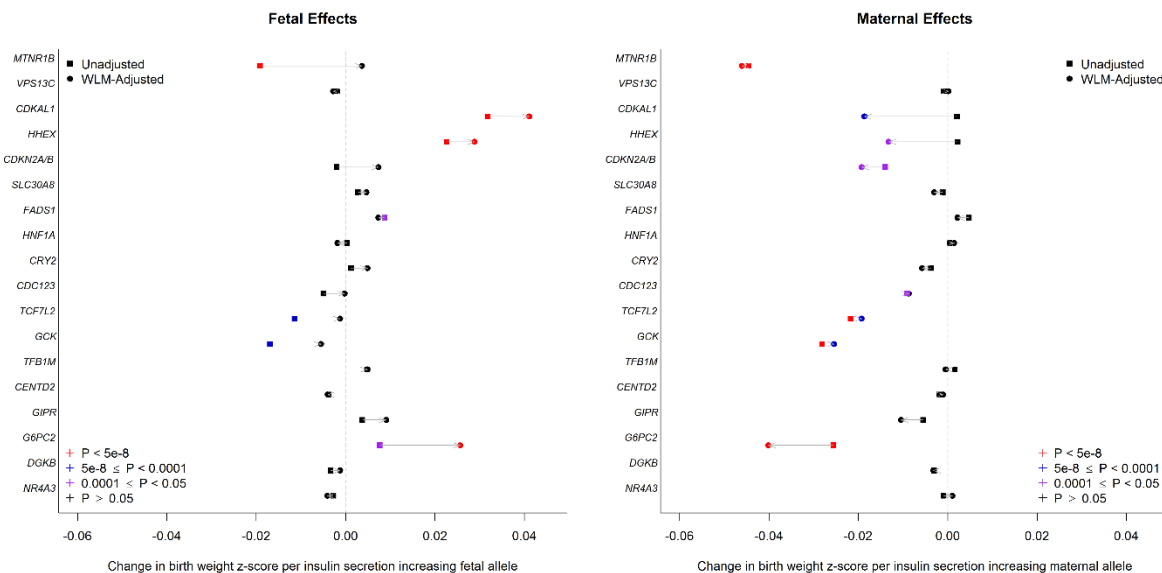

### Supplementary Figure 13

Summary of previously reported loci for insulin secretion and their effect on birth weight.

(a): Effect size (y-axis) of the 18 previously reported SNPs for insulin secretion plotted against the effect on birth weight (x-axis) from the weighted linear model (WLM)-adjusted fetal effect on own birth weight in the left plot and the WLM-adjusted maternal effect on offspring birth weight in the right plot. The colour of each dot indicates the birth weight association P-value, which were calculated using a two-sided Wald test. (b): effect sizes on birth weight (x-axis) for the 18 known insulin secretion SNPs (y-axis) in the GWAS meta-analysis (squares) for own birth weight (left plot) and offspring birth weight (right plot). The circles in the left plot represent the WLM-adjusted fetal effect on own birth weight, and in the right plot they represent the WLM-adjusted maternal effect on offspring birth weight. The colour of each point indicates the birth weight association P-value, which were calculated using a two-sided Wald test. The arrows indicate the change in the effect estimate after adjustment. Details of the SNPs are provided in Supplementary Table 14.

(a)

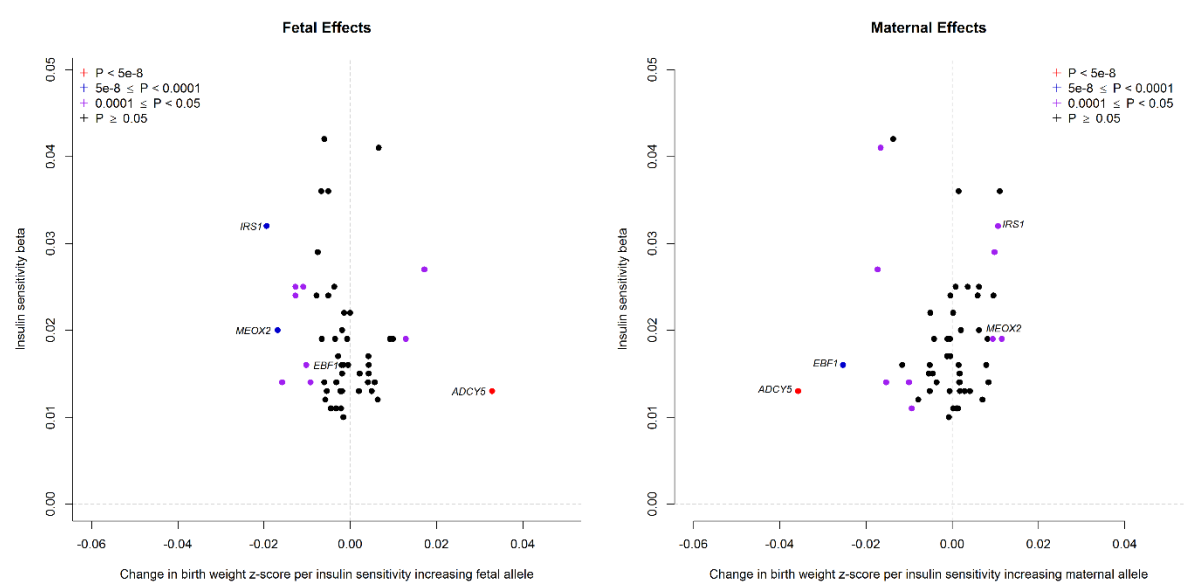

(b)

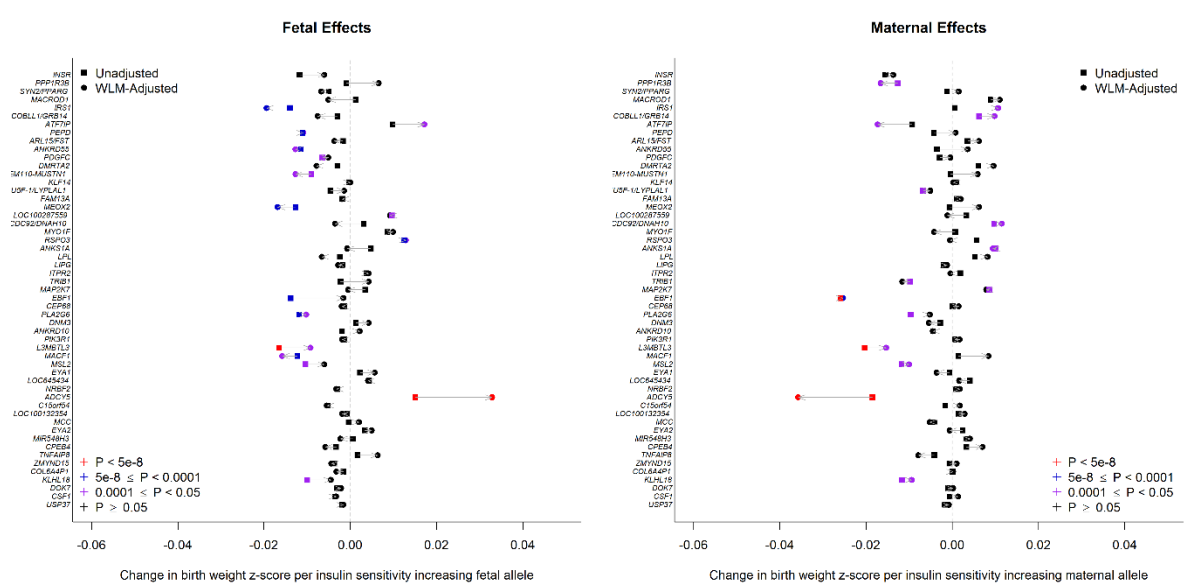

### Supplementary Figure 14

Summary of previously reported loci for insulin sensitivity and their effect on birth weight.

(a): Effect size (y-axis) of the 53 previously reported SNPs for insulin sensitivity plotted against the effect on birth weight (x-axis) from the weighted linear model (WLM)-adjusted fetal effect on own birth weight in the left plot and the WLM-adjusted maternal effect on offspring birth weight in the right plot. The colour of each dot indicates the birth weight association P-value, which were calculated using a two-sided Wald test. (b): effect sizes on birth weight (x-axis) for the 53 known insulin sensitivity SNPs (y-axis) in the GWAS meta-analysis (squares) for own birth weight (left plot) and offspring birth weight (right plot). The circles in the left plot represent the WLM-adjusted fetal effect on own birth weight, and in the right plot they represent the WLM-adjusted maternal effect on offspring birth weight. The colour of each point indicates the birth weight association P-value, which were calculated using a two-sided Wald test. The arrows indicate the change in the effect estimate after adjustment. Details of the SNPs are provided in Supplementary Table 14.



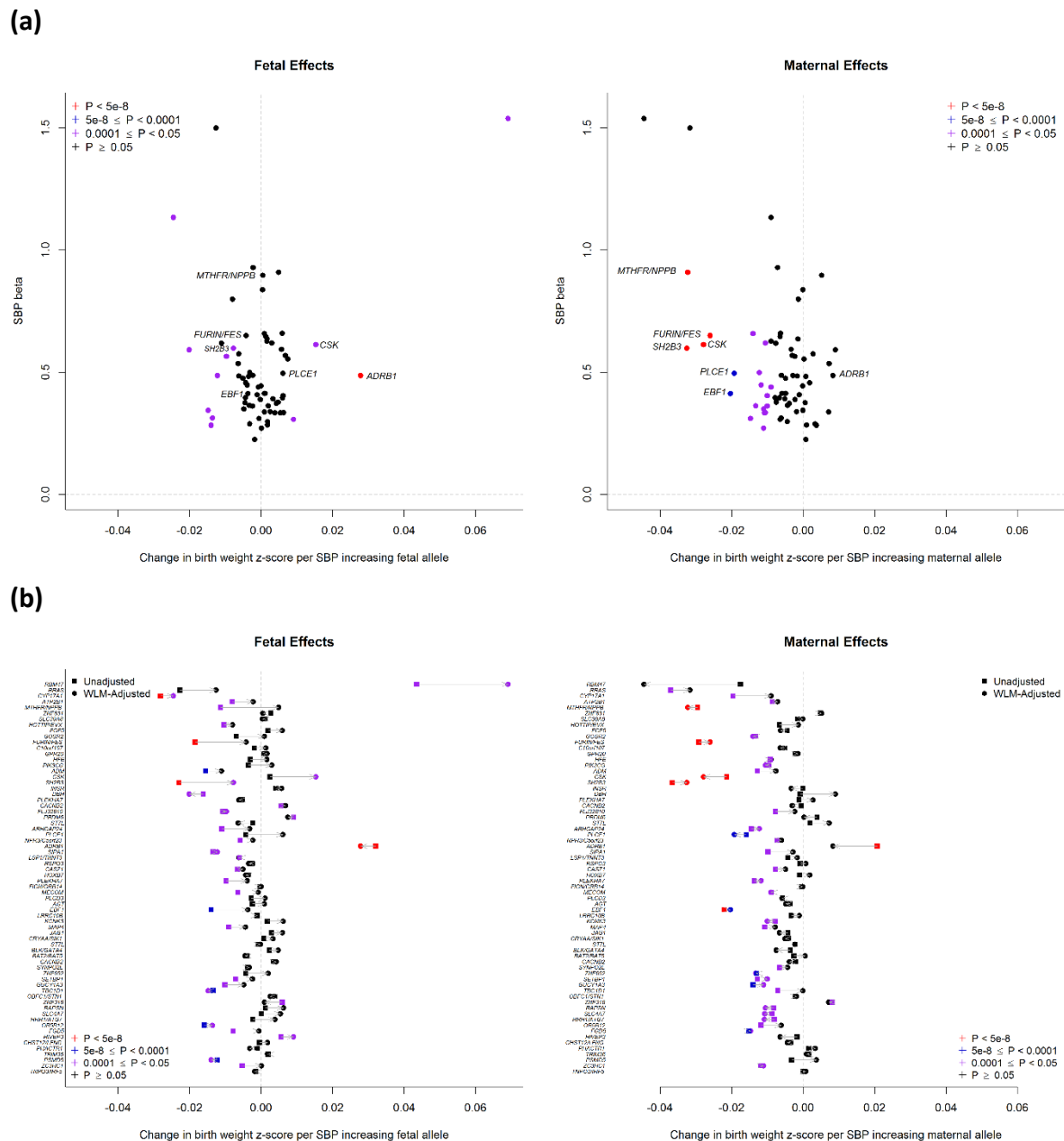

### Supplementary Figure 15

Summary of previously reported loci for systolic blood pressure (SBP) and their effect on birth weight.

(a): Effect size (y-axis) of the 68 previously reported SNPs for SBP plotted against the effect on birth weight (x-axis) from the weighted linear model (WLM)-adjusted fetal effect on own birth weight in the left plot and the WLM-adjusted maternal effect on offspring birth weight in the right plot. The colour of each dot indicates the birth weight association P-value, which were calculated using a two-sided Wald test. (b): effect sizes on birth weight (x-axis) for the 68 known SBP SNPs (y-axis) in the GWAS meta-analysis (squares) for own birth weight (left plot) and offspring birth weight (right plot). The circles in the left plot represent the WLM-adjusted fetal effect on own birth weight, and in the right plot they represent the WLM-adjusted maternal effect on offspring birth weight. The colour of each point indicates the birth weight association P-value, which were calculated using a two-sided Wald test. The arrows indicate the change in the effect estimate after adjustment. Details of the SNPs are provided in Supplementary Table 14.

(a)

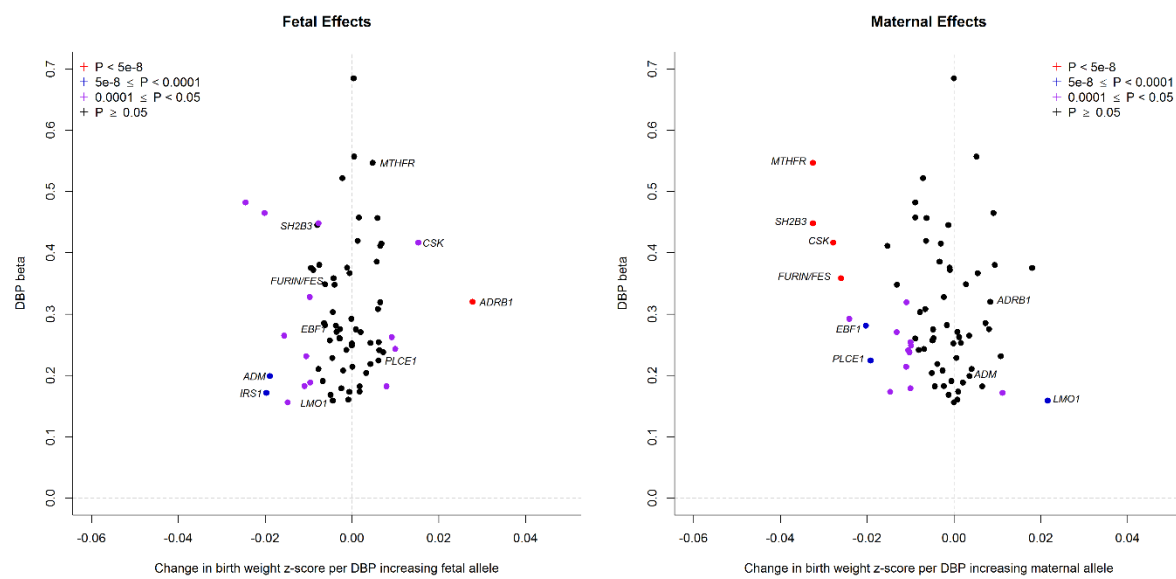

(b)

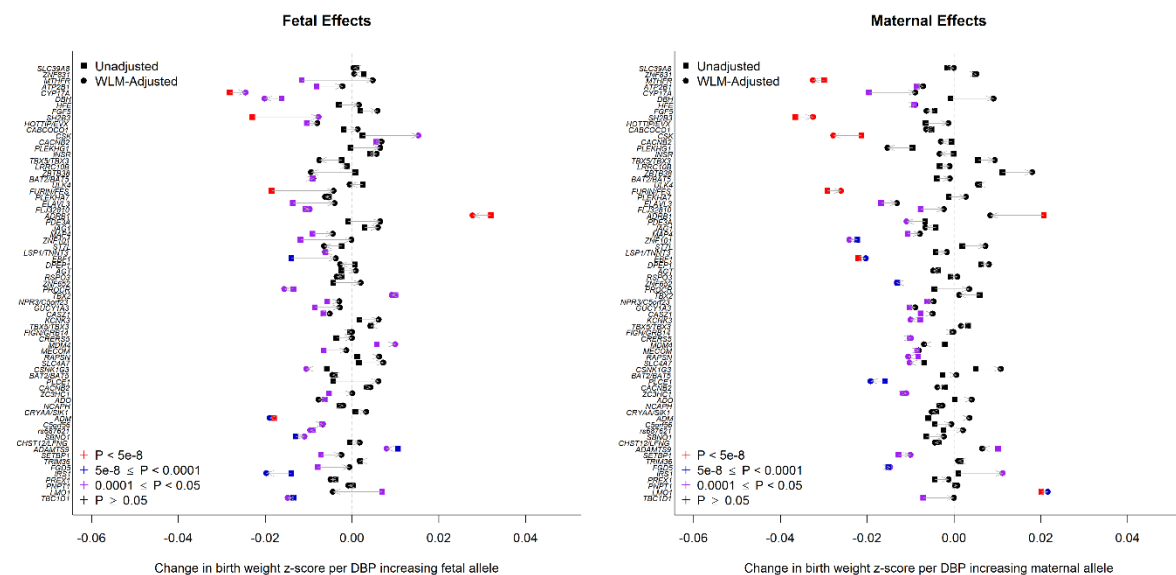

### Supplementary Figure 16

Summary of previously reported loci for diastolic blood pressure (DBP) and their effect on birth weight.

(a): Effect size (y-axis) of the 71 previously reported SNPs for DBP plotted against the effect on birth weight (x-axis) from the weighted linear model (WLM)-adjusted fetal effect on own birth weight in the left plot and the WLM-adjusted maternal effect on offspring birth weight in the right plot. The colour of each dot indicates the birth weight association P-value, which were calculated using a two-sided Wald test. (b): effect sizes on birth weight (x-axis) for the 71 known DBP SNPs (y-axis) in the GWAS meta-analysis (squares) for own birth weight (left plot) and offspring birth weight (right plot). The circles in the left plot represent the WLM-adjusted fetal effect on own birth weight, and in the right plot they represent the WLM-adjusted maternal effect on offspring birth weight. The colour of each point indicates the birth weight association P-value, which were calculated using a two-sided Wald test. The arrows indicate the change in the effect estimate after adjustment. Details of the SNPs are provided in Supplementary Table 14.

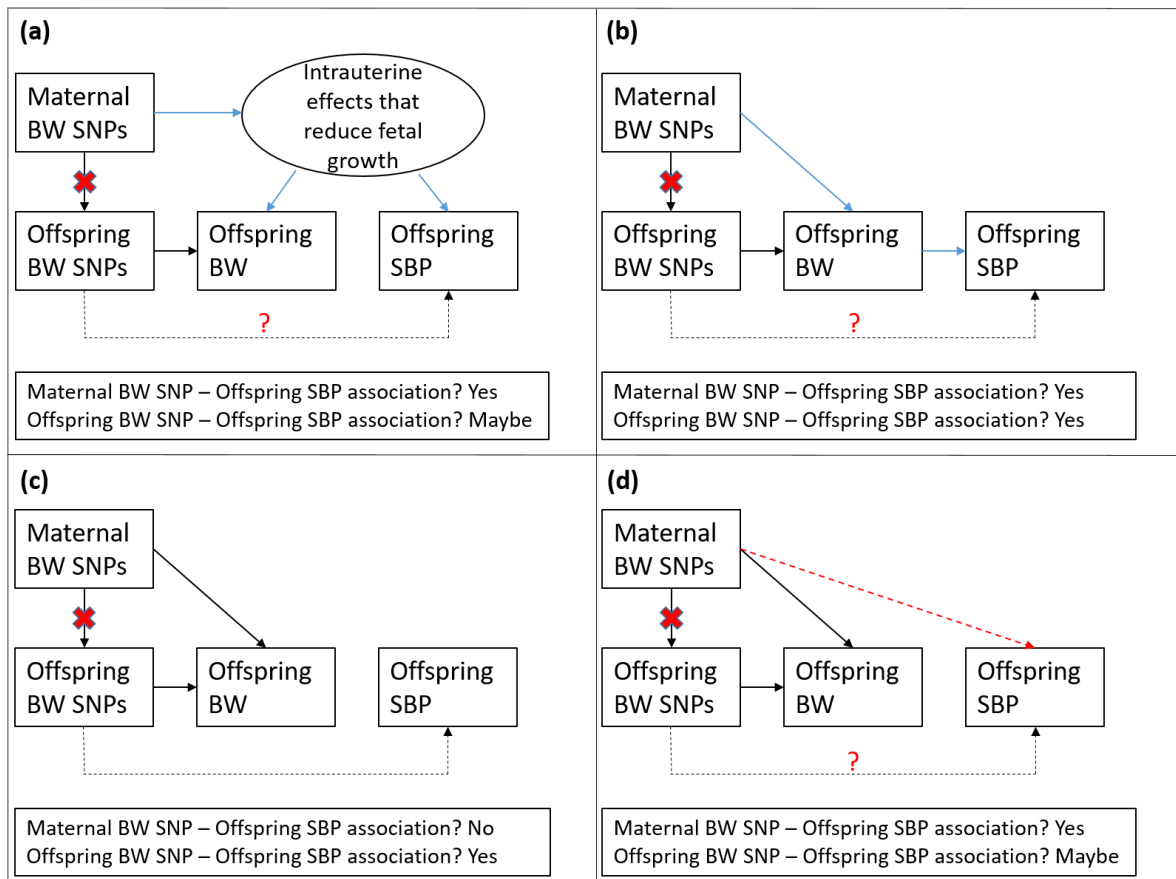

**Supplementary Figure 17**

Possible explanations for the negative genetic correlation between birth weight (BW) and later life systolic blood pressure (SBP).

SNPs may exert indirect maternal and/or direct fetal genetic effects on birth weight. The dashed black path represents the direct fetal effects of inherited birth weight -lowering alleles that also increase offspring SBP. The blue paths represent indirect (intrauterine) effects of maternal SNPs associated with both reduced offspring birth weight and higher offspring SBP. The dashed red path represents possible postnatal effects of maternal SNPs. A red cross indicates a blocked path due to conditioning on offspring/maternal genotype. The existence of SNPs in the mother that exert indirect maternal genetic effects on both offspring birth weight and SBP implies pathways consistent with the Developmental Origins of Health and Disease (DOHaD) hypothesis (blue paths in **panels a and b**). For example, in **panel (a)**, maternal SNPs associated with offspring birth weight produce an adverse intrauterine environment that leads to both reduced fetal growth (and hence birth weight) and to developmental compensations that cause higher offspring SBP in later-life. Under this scenario, SNPs with maternal effects on offspring birth weight will be inversely associated with offspring SBP, whereas SNPs that exert fetal effects on birth weight may not be inversely associated with SBP after conditioning on maternal genotype (depending on whether these fetal genotypes also exert pleiotropic effects on offspring SBP in later life, as indicated by the dashed path with the red question mark).

In **panel (b)**, lower offspring birth weight is causal for higher offspring SBP. Under this scenario, SNPs with maternal effects on offspring birth weight will be inversely associated with offspring SBP, as will SNPs with direct fetal effects on birth weight. We stress that although this model is broadly consistent with the DOHaD hypothesis, birth weight *itself* is generally not considered to be directly causal for future cardio-metabolic risk, but rather a marker of an adverse intrauterine environment, like in **panel (a)**. Nevertheless, it is important to consider this possibility, particularly as naïve analyses making similar assumptions have begun to appear<sup>4-6</sup>. Importantly, under **panels (a) and (b)**, the existence of an inverse association between maternal birth weight -associated SNPs and offspring SBP would provide strong support for the DOHaD hypothesis.

In **panel (c)**, the negative genetic correlation between offspring birth weight and offspring SBP is driven by pleiotropic effects of SNPs inherited by the offspring. This model encompasses the possibility of maternal SBP-associated SNPs directly affecting offspring birth weight. These SBP alleles are then transmitted to the offspring where they increase offspring SBP in later life. Under this scenario, offspring birth weight SNPs may be inversely associated with offspring SBP through genetic pleiotropy, whereas maternal SNPs will not be inversely

associated with offspring SBP after conditioning on offspring genotype. In other words, under this model (which is inconsistent with DOHaD), there is no inverse association between maternal birth weight -associated SNPs and offspring SBP.

Finally, in **panel (d)**, SNPs that exert indirect maternal effects on offspring birth weight also pleiotropically influence offspring SBP through the postnatal environment. Under this model, SNPs with maternal intrauterine effects on offspring birth weight will be associated with offspring SBP, whereas SNPs that exert fetal effects on birth weight may not be associated with offspring SBP after conditioning on maternal genotype (again depending on the existence of pleiotropy in the fetal genome). In general, however, we think this last model is less likely since the primary effect of these variants is likely to be on birth weight through the intrauterine environment. Any postnatal environmental effects of these variants, if they exist, on offspring SBP are likely to be small in comparison to their intrauterine effects. We note that the availability of mature genotyped father-offspring duos allows us to test this assumption, since we would expect that paternal genotypes not to be associated with offspring SBP (after conditioning on offspring genotype) in the absence of postnatal environmental effects.

The scenario in **panel (c)** is the most consistent scenario with the results of the current study. NB We have not included environmental factors in these diagrams because our focus is on explaining the genetic correlation between variables.

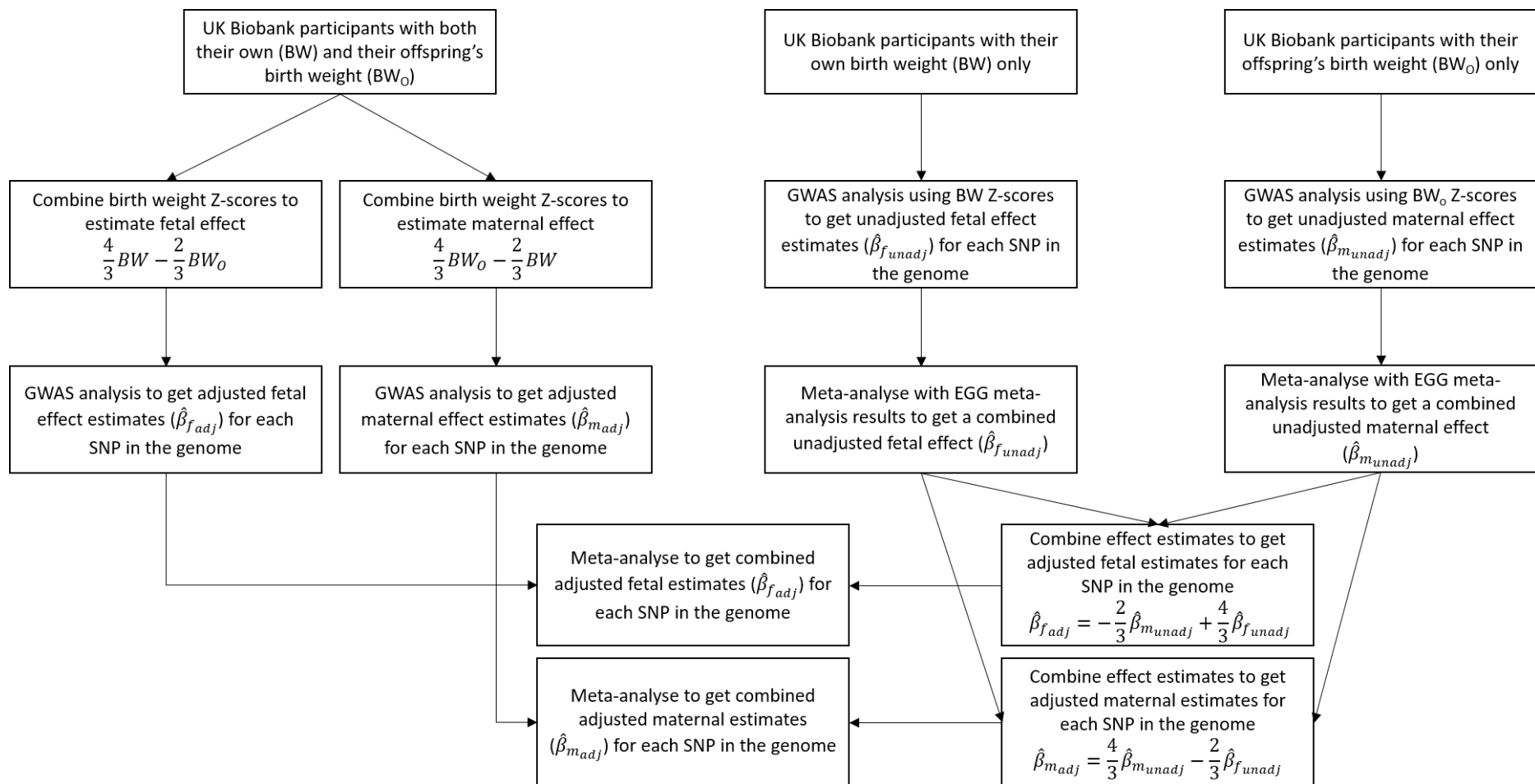

**Supplementary Figure 18**

Flow diagram outlining the analysis pipeline to estimate the weighted linear model (WLM)-adjusted fetal and maternal effects on birth weight for each SNP in the genome.

**Supplementary Table 1. Description of studies contributing to trans-ancestry GWAS meta-analysis of own birth weight: ancestry group and country of origin, sample size, data collection methods, and birth weight summaries and exclusions.**

(a) Component 1: European ancestry GWAS

Study	Ancestry group	Country of origin	Year(s) of birth	Sample size (M/F)	Data collection	Phenotype exclusions	Mean (SD) birth weight (grams)			Median (IQR) GA (week) at delivery
							Males	Females	Combined	
1958 British Birth Cohort	European	UK	1958	4,595 (2,320/2,275)	Measured by midwives; supplemented with obstetric records and interviews with mothers	Multiple births, GA <37 weeks	3439 (484)	3277 (468)	3359 (483)	40 (39-41)
ABCD	European	Netherlands	2003-2004	1,107 (536/571)	Youth Health Care Registration	Multiple births, GA <37 weeks	3616 (502)	3498 (449)	3555 (479)	40 (39-41)
ALSPAC <sup>a,b</sup>	European	UK	~1992	7,285 (3,722/3,563)	Identified from obstetric data, records from the ALSPAC measurers, and birth notification	Multiple births, GA <37 weeks, 5 SD winsorisation	3553 (491)	3423 (450)	3490 (476)	40 (40-41)
CHOP-Caucasian	European	USA	1988-present	9,405 (5,040/4,365)	Questionnaire and medical records	Multiple births, GA <37 weeks (when available)	3447 (582)	3343 (549)	3398 (569)	N/A
CoLaus	European	Switzerland	1928-1970	2,089 (892/1,197)	Self-reported as adults	N/A	3490 (668)	3250 (661)	3352 (675)	N/A
COPSAC-2000	European	Denmark	1998-2001	352 (173/179)	Medical records	Multiple births, GA <37 weeks	N/A	N/A	3555 (485)	40 (39-41)
COPSAC-2010	European	Denmark	2008-2011	589 (306/283)	Medical records	Multiple births, GA <37 weeks	3635 (483)	3536 (474)	3588 (481)	40 (39-41)
COPSAC-REGISTRY	European	Denmark	1987-1999	1,210 (804/406)	Medical Records	Multiple births, GA <37 weeks	3609 (498)	3443 (447)	3553 (488)	40 (39-41)
DNBC	European	Denmark	1996-2003	915 (475/440)	Danish Medical Birth Register	Multiple births, GA <37 weeks, congenital abnormalities	3767 (480)	3625 (443)	3699 (468)	40 (40-41)
ERF	European	Netherlands	Various	459 (187/272)	Interview	GA <37 weeks	3161 (680)	2955 (608)	3039 (644)	N/A
EPIC	European	UK	1993-1997	8,939 (3,448/5,491)	Self-reported	N/A	3505 (786)	3266 (750)	3358 (772)	N/A
Fenland (GA+)	European	UK	1950-1975	5,188 (2,088/3,100)	Self-reported as adults	GA described as "very pre-term" or "pre-term"	3433 (638)	3260 (594)	3394 (555)	N/A
Fenland (GA-)	European	UK	1950-1975	833 (509/324)	Self-reported as adults	None	3465 (593)	3154 (608)	3354 (624)	N/A
Generation R	European	Netherlands	2002-2006	2,701 (1,378/1,323)	Hospital records and community midwives	Multiple births, GA <37 weeks	3628 (494)	3518 (475)	3574 (488)	40 (39-41)

Study	Ancestry group	Country of origin	Year(s) of birth	Sample size (M/F)	Data collection	Phenotype exclusions	Mean (SD) birth weight (grams)			Median (IQR) GA (week) at delivery
							Males	Females	Combined	
GINIplus & LISA (GA+)	European	Germany	1996-1999	656 (360/296)	Parental report of medical records	Multiple births, GA <37 weeks, <2500g	3498 (406)	3376 (417)	3443 (415)	40 (39-41)
GINIplus & LISA (GA-)	European	Germany	1996-1999	790 (391/399)	Parental report of medical records	Multiple births, GA <37 weeks, <2500g	3499 (429)	3348 (423)	3423 (433)	N/A
GOYA	European	Denmark	1943-1952	149/0 (obese), 141/0 (control)	School health records	N/A	N/A	N/A	3553 (711)	N/A
GOYA offsprings	European	Denmark	1996-2002	907 (461/446)	Measured by midwives and obtained from the Danish National Birth Registry	Multiple births, GA <37 weeks	3808 (504)	3696 (482)	3753 (496)	40 (39-41)
HAPO-EUR	Caucasian	Canada, UK, Australia	2000-2006	1,333 (659/664)	Measured within 72 hours of birth using methods and equipment standardized across all centres	Multiple births, GA <37 weeks, abs(BW-z)>5	3500 (500)	3352 (485)	3425 (498)	40 (39-41)
HBCS	European	Finland	1934-1944	1,472 (639/833)	Birth records	Multiple births, GA <37 weeks	3536 (460)	3375 (439)	3444 (454)	40 (39-41)
HEALTH2006	European	Denmark	1927-1988	1,176 (442/734)	Self-reported as adults	None	3487 (614)	3257 (564)	3343 (593)	NA
INMA	European	Spain	1997-2006	1,021 (527/494)	Well-trained midwives and nurses	None	3362 (406)	3188 (422)	3278 (423)	40 (39-41)
INTER99	European	Denmark	1939-1969	4,243 (1,981/2,262)	Measured by midwives and obtained from obstetric record registry	Multiple births, GA <37 weeks	3505 (493)	3370 (469)	3433 (485)	N/A
Leipzig	European	Germany	1985 - 2010	597 (304/293)	Questionnaire to mothers, documentation of medical screening examination if available	GA <37 weeks	3573 (531)	3480 (538)	3527 (536)	40 (39-40)
NEO	European	Netherlands	1943-1963	504 (exact; 200/304), 3,215 (range; 1,450/1,765)	Questionnaire	N/A	3669 (1068)	3236 (973)	3514 (1271)	N/A
NFBC1966	European	Finland	1966	5,009 (2,393/2,616)	Measured in hospitals	Multiple births, GA <37 weeks or unknown	3607 (506)	3480 (466)	3541 (489)	40 (39-41)
NFBC1986	European	Finland	1986	4,680 (2,306/2,374)	Measured in hospitals	Multiple births, GA <37 weeks or unknown	3626 (543)	3519 (521)	3572 (535)	40 (39-40)
NTR	European	Netherlands	1926-1998	1,265 (447/818)	Parental report or self-reported	Multiple births, GA <37 weeks	3414 (619)	3544 (630)	3343 (601)	40 (40-40)
ORCADES	European	Scotland	1920-1991	960 (330/630)	Self-reported as adults	N/A	3401 (607)	3654 (685)	3488 (640)	N/A
PANIC	European	Finland	1999-2002	436 (231/205)	Medical records and parental questionnaire	Multiple births, GA <37 weeks	3646 (488)	3528 (444)	3588 (474)	40 (39-41)
RAINE	European	Australia	1989-1991	1,347 (693/654)	Recorded at delivery by study personnel or obtained from hospital reports	Multiple births, GA <37 weeks	3505 (471)	3390 (462)	3449 (470)	40 (39-41)

Study	Ancestry group	Country of origin	Year(s) of birth	Sample size (M/F)	Data collection	Phenotype exclusions	Mean (SD) birth weight (grams)			Median (IQR) GA (week) at delivery
							Males	Females	Combined	
SKOT	European	Denmark	2006-2007, 2011-2013	348 (173/175)	Measured by midwives and general practitioners; obtained from health records kept by the parents	Multiple births, GA <37 weeks	3706 (472)	3509 (475)	3607 (483)	40 (39-41)
SORBS	European	Germany	1925-1988	298 (113/185)	Interview at recruitment	N/A	N/A	N/A	3393 (673)	N/A
STRIP	European	Finland	1989-1991	599 (311/288)	Medical records	Multiple births, GA <37 weeks	3696 (471)	3535 (443)	3619 (465)	40 (39-40)
TEENAGE (GA+)	European	Greece	1993-1998	279 (126/153)	Measured by midwives or paediatricians; supplemented with data from mothers' interviews	GA <37 weeks	3403 (467)	3280 (421)	3336 (445)	40 (38-40)
TEENAGE (GA-)	European	Greece	1993-1998	551 (234/317)	Measured by midwives or paediatricians; supplemented with data from mothers' interviews	N/A	3398 (459)	3298 (438)	3341 (449)	N/A
TDCOB-cases	European	Denmark	1987-2007	669 (391/278)	Measured by midwives and registered in Danish Civil Registry	Multiple births	3682 (536)	3629 (545)	3660 (540)	40 (39-41)
TDCOB-controls	European	Denmark	1991-2006	560 (211/349)	Measured by midwives and registered in Danish Civil Registry	Multiple births	3627 (517)	3483 (485)	3540 (502)	40 (39-41)
YFS	European	Finland	1962-1977	1,915 (861/1,054)	Mothers' interview	Multiple births, GA >3 weeks pre-term	3648 (491)	3510 (451)	3572 (475)	N/A

(b) Component 2: UK Biobank (European only or All samples)

Study	Ancestry group	Country of origin	Year(s) of birth	Sample size (M/F)	Data collection	Phenotype exclusions	Mean (SD) birth weight (grams)			Median (IQR) GA (weeks) at delivery
							Males	Females	Combined	
UK Biobank	European	UK	2006-2010	217,397 (85,063/132,334)	Self-reported as adults	Multiple births, birth weight <2500g or >4500g	3455 (416)	3350 (415)	3391 (418)	N/A
UK Biobank	All	UK	2006-2010	227,530 (89,037/138,493)	Self-reported as adults	Multiple births, birth weight <2500g or >4500g	3452 (417)	3346 (415)	3387 (419)	N/A



(c) Component 3: Non-European ancestry GWAS

Study	Ancestry group	Country of origin	Year(s) of birth	Sample size (M/F)	Data collection	Phenotype exclusions	Mean (SD) birth weight (grams)			Median (IQR) GA (weeks) at delivery
							Males	Females	Combined	
CHOP-AA	African American	USA	1988-present	6,635 (3,343/3,292)	Questionnaire and medical records	Multiple births, GA <37 weeks (when available)	3276 (554)	3184 (535)	3231 (546)	N/A
CLHNS	Filipino	Philippines	1983-1984	1,449 (755/694)	Local birth attendants	Multiple births, GA <37 weeks	3067 (401)	3018 (403)	3043 (403)	40 (38-40)
Generation R Turkish	Turkish	Netherlands	2002-2006	420 (215/205)	Hospital records and community midwives	Multiple births, GA <37 weeks	3477 (500)	3369 (415)	3424 (463)	40 (39-41)
Generation R Moroccan	Moroccan	Netherlands	2002-2006	365 (188/177)	Hospital records and community midwives	Multiple births, GA <37 weeks	3642 (447)	3417 (344)	3533 (416)	41 (40-41)
Generation R Surinamese	Surinamese	Netherlands	2002-2006	395 (215/180)	Hospital records and community midwives	Multiple births, GA <37 weeks	3288 (556)	3130 (490)	3216 (532)	40 (39-41)
HAPO-AC	Afro-Caribbean	Barbados	2000-2006	1,052 (544/508)	Measured within 72 hours of birth using methods and equipment standardized across all centres	Multiple births, GA <37 weeks, abs(BW-z)>5	3288 (460)	3163 (410)	3228 (441)	40 (39-41)
HAPO-MA	Hispanic	USA	2000-2006	612 (303/309)	Measured within 72 hours of birth using methods and equipment standardized across all centres	Multiple births, GA <37 weeks, abs(BW-z)>5	3463 (438)	3408 (431)	3435 (435)	40 (39-41)
HAPO-TH	Thai	Thailand	2000-2006	1,180 (575/605)	Measured within 72 hours of birth using methods and equipment standardized across all centres	Multiple births, GA <37 weeks, abs(BW-z)>5	3163 (385)	3027 (368)	3093 (382)	40 (39-41)
SCORM	Chinese	Singapore	1992-1995	840 (420/420)	Documented medical record booklet	GA <37 weeks	3229 (422)	3182 (475)	3205 (450)	39 (38-40)

M, Males; F, Females; GA, gestational age; IQR, interquartile range; N/A, not applicable; SD, standard deviation.

<sup>a</sup>Boyd A, Golding J, Macleod J, Lawlor DA, Fraser A, et al. Cohort Profile: the 'children of the 90s'--the index offspring of the Avon Longitudinal Study of Parents and Children. *Int J Epidemiol* 42, 111-127 (2013).

<sup>b</sup>The study website contains details of all the data that is available through a fully searchable data dictionary (<http://www.bris.ac.uk/alspac/researchers/data-access/data-dictionary/>).

**Supplementary Table 2. Description of studies contributing to trans-ancestry GWAS meta-analysis of own birth weight: genotyping, quality control, pre-phasing, imputation, and association analysis.**

(a) Component 1: European ancestry GWAS

Study	Genotyping array(s) <sup>a</sup>	Sample quality control		SNP scaffold quality control			Prephasing software	Imputation		Association analysis		Lambda (M/F)
		Call rate	Additional filters	Call rate	HWE P-value	Frequency		Software	Reference panel	Software	Covariates or adjustment	
1958 British Birth Cohort	I550, I610	None	Relatedness, ancestry outliers, sex discrepancy, identity, channel contrast	95%	1x10 <sup>-4</sup>	MAF<1%	MaCH	Minimac	1000G Mar 2012	ProbABEL	GA	1.01/1.00
ABCD	ICE	97%	Heterozygosity, relatedness, sex discrepancy, identity	95%	1x10 <sup>-6</sup>	MAF<1%	SHAPEIT2	IMPUTE2	1000G Mar 2012	SNPTEST	GA, PC1-4	0.95/0.95
ALSPAC	I550	97%	Heterozygosity, relatedness, ancestry outliers	95%	5x10 <sup>-7</sup>	MAF<1%	SHAPEIT2	IMPUTE2	1000G Mar 2012	SNPTEST	GA, PC7	1.02/1.01
CHOP-Caucasian	I550, I610	95%	Relatedness, ancestry outliers, sex discrepancy	95%	1x10 <sup>-6</sup>	MAF<1%	SHAPEIT2	IMPUTE2	1000G Mar 2012	SNPTEST	PC1-3	0.96/0.96
CoLaus	A5	90%	Relatedness, ancestry outliers	90%	1x10 <sup>-7</sup>	MAF<1%	MaCH	Minimac	1000G Mar 2012	In-house	None	0.99/1.00
COPSAC-2000	I550	97.5%	Heterozygosity, relatedness, ancestry outliers	98%	1x10 <sup>-6</sup>	MAF<0.1%	MaCH	Minimac	1000G Mar 2012	mach2qtl	GA	1.00/1.01
COPSAC-2010	IOEE	95%	Heterozygosity, relatedness, ancestry outliers, sex discrepancy	95%	1x10 <sup>-6</sup>	MAF<1%	SHAPEIT2	IMPUTE2	1000G Mar 2012	QuickTest	GA, PC1-5	1.01/1.00
COPSAC-REGISTRY	IOEE	95%	Heterozygosity, relatedness, ancestry outliers, sex discrepancy	97.5%	1x10 <sup>-6</sup>	MAF<1%	SHAPEIT2	IMPUTE2	1000G Mar 2012	QuickTest	GA, PC1-5	1.00/1.00
DNBC	I660	96%	Heterozygosity, ancestry outliers, sex discrepancy	98%	1x10 <sup>-6</sup>	MAF<1%	SHAPEIT2	IMPUTE2	1000G Mar 2012	SNPTEST	GA	1.00/1.00
ERF	Various	98%	Relatedness, ancestry outliers, sex discrepancy	98%	5x10 <sup>-8</sup>	MAF<0.5%	MaCH	Minimac	1000G Mar 2012	ProbABEL	Kinship matrix	1.02/0.95
EPIC	AUKBB	97%	Heterozygosity, relatedness, sex discrepancy, singletons, channel contrast	95%	1x10 <sup>-6</sup>	MAC<1	SHAPEIT	IMPUTE2	1000G Mar 2012	SNPTEST	PC1-10	1.00/1.01
Fenland (GA+)	AUKBB	95%	Sex discrepancy, identity	95%	1x10 <sup>-6</sup>	MAC<2	SHAPEIT	IMPUTE2	1000G Mar 2012	SNPTEST	GA, PC1-10	1.00/1.01
Fenland (GA-)	AUKBB	95%	Sex discrepancy, identity	95%	1x10 <sup>-6</sup>	MAC<2	SHAPEIT	IMPUTE2	1000G Mar 2012	SNPTEST	PC1-10	0.99/1.00
Generation R	I610, I660	97.5%	Heterozygosity, ancestry outliers, sex discrepancy	98%	1x10 <sup>-6</sup>	MAF<1%	MaCH	Minimac	1000G Mar 2012	mach2qtl	GA, PC1-4	1.03/1.01
GINIplus & LISA	A5, A6	95%	Heterozygosity, ancestry outliers, sex discrepancy	95%	1x10 <sup>-5</sup>	MAF<1%	SHAPEIT2	IMPUTE2	1000G Mar 2012	SNPTEST	GA	0.99/1.00
GOYA	I610	95%	Heterozygosity, ancestry outliers, sex discrepancy	95%	1x10 <sup>-7</sup>	MAF<1%	MaCH	MaCH	1000G Mar 2012	QuickTest	None	1.00/0.99

Study	Genotyping array(s) <sup>a</sup>	Sample quality control		SNP scaffold quality control			Prephasing software	Imputation		Association analysis		Lambda (M/F)
		Call rate	Additional filters	Call rate	HWE <i>p</i> -value	Frequency		Software	Reference panel	Software	Covariates or adjustment	
GOYA offsprings	ICE	95%	Heterozygosity, relatedness	95%	1x10 <sup>-6</sup>	MAF<1%	SHAPEIT	IMPUTE2	1000G Mar 2012	SNPTEST	GA	1.00/1.01
HAPO-EUR	I610	97%	Heterozygosity, relatedness, non-European ancestry, sex discrepancy, chromosomal anomalies	98%	1x10 <sup>-4</sup>	MAF<2%	IMPUTE2	IMPUTE2	1000G Mar 2012	R	GA, PC1-2, field centre	0.99/1.00
HBCS	I670	95%	Heterozygosity, relatedness, ancestry outliers	95%	1x10 <sup>-6</sup>	MAF<1%	MaCH	MaCH	1000G Mar 2012	mach2qtl	GA	1.02/1.02
HEALTH2006	ICM	95%	Relatedness, non-European ancestry, sex discrepancy	95%	1x10 <sup>-4</sup>	MAF<1%	IMPUTE2	IMPUTE2	1000G Mar 2012	SNPTEST	PC1	1.02/0.98
INMA	IOQ	98%	Heterozygosity, relatedness, ancestry outliers, duplicates	95%	1.1x10 <sup>-6</sup>	MAF<1%	IMPUTE2	IMPUTE2	1000G Mar 2012	SNPTEST	GA	1.00/0.99
INTER99	ICM	95%	Relatedness, ancestry outliers, sex discrepancy	95%	1x10 <sup>-4</sup>	MAF<1%	IMPUTE2	IMPUTE2	1000G Mar 2012	SNPTEST	PC1	0.97/1.02
Leipzig	ICM	95%	Duplicates, ancestry outliers, sex discrepancy	95% (99% if MAF<5%)	1x10 <sup>-4</sup>	MAF<1%	IMPUTE2	IMPUTE2	1000G Mar 2012	SNPTEST	GA	0.95/0.96
NEO	ICE	98%	Heterozygosity, relatedness, ancestry outliers, sex discrepancy	98%	1x10 <sup>-6</sup>	None	IMPUTE2	IMPUTE2	1000G Mar 2012	SNPTEST	PC1-5	0.99/0.99
NFBC1966	I370	95%	Heterozygosity, relatedness, ancestry outliers, sex discrepancy, duplicates, withdrawn consent	95% (99% if MAF<5%)	5.7x10 <sup>-7</sup>	MAF<1%	SHAPEIT2	IMPUTE2	1000G Mar 2012	SNPTEST	GA, PC1-3	1.00/0.99
NFBC1986	ICM	95%	Heterozygosity, relatedness, ancestry outliers, sex discrepancy, duplicates, withdrawn consent	95% (99% if MAF<5%)	5.7x10 <sup>-7</sup> (1x10 <sup>-4</sup> if MAF<5%)	MAF<1%	SHAPEIT2	IMPUTE2	1000G Mar 2012	SNPTEST	GA, PC1-3	1.00/1.10
NTR	A6, I370, I660, IOQ	90%	Heterozygosity, relatedness, ancestry outliers, sex discrepancy	95%	1x10 <sup>-5</sup>	MAF<1%	MaCH	Minimac	1000G Mar 2012	PLINK	GA, array, PC1-6 (global), PC1-3 (local)	1.08/1.04
ORCADES	I300, IOQ, IOE	95%	Heterozygosity, relatedness, ancestry outliers, sex discrepancy, duplicates	95% (99% if MAF<5%)	1x10 <sup>-6</sup>	MAF<1%	SHAPEIT	IMPUTE2	1000G Mar 2012	ProbABEL	array, PC1-3	1.00/0.99
PANIC	ICM, ICE	90%	Heterozygosity, relatedness, ancestry outliers, sex discrepancy	95%	1x10 <sup>-6</sup>	MAF<1%	SHAPEIT2	IMPUTE2	1000G Mar 2012	SNPTEST	GA, PC1-4	1.01/1.01
RAINE	I660	97%	Heterozygosity, relatedness, ancestry outliers, sex discrepancy, chromosomal abnormalities	95%	5.7x10 <sup>-7</sup>	MAF<1%	MaCH	MaCH	1000G Mar 2012	ProbABEL	GA, PC1-2	1.01/0.99

Study	Genotyping array(s) <sup>a</sup>	Sample quality control		SNP scaffold quality control			Prephasing software	Imputation		Association analysis		Lambda (M/F)
		Call rate	Additional filters	Call rate	HWE <i>p</i> -value	Frequency		Software	Reference panel	Software	Covariates or adjustment	
SKOT	ICE	95%	Heterozygosity, relatedness	95%	1x10 <sup>-6</sup>	MAF<1%	SHAPEIT	IMPUTE2	1000G Mar 2012	SNPTEST	GA	1.01/1.01
SORBS	I660	94%	Relatedness, ancestry outliers, sex discrepancy, duplicates	95%	1x10 <sup>-4</sup>	MAF<1%	MaCH	Minimac	1000G Mar 2012	ProbABEL	Kinship matrix	1.01/1.01
STRIP	A5, A6	95%	Heterozygosity, ancestry outliers, twins	95%	1x10 <sup>-6</sup>	MAF<0.1%	SHAPEIT	IMPUTE2	1000G Mar 2012	SNPTEST	GA, PC1-4	1.01/1.01
TEENAGE (GA+)	ICM	95%	Heterozygosity, relatedness, ancestry outliers, sex discrepancy	95% (99% if MAF<5%)	1x10 <sup>-4</sup>	MAF<1%	SHAPEIT	IMPUTE2	1000G Mar 2012	SNPTEST	GA	1.02/1.00
TEENAGE (GA-)	IOE	95%	Heterozygosity, relatedness, ancestry outliers, sex discrepancy	95% (99% if MAF<5%)	1x10 <sup>-4</sup>	MAF<1%	SHAPEIT	IMPUTE2	1000G Mar 2012	SNPTEST	None	1.02/0.98
TDCOB-cases	IOE	95%	Heterozygosity, relatedness, ancestry outliers	95%	1x10 <sup>-6</sup>	MAF<1%	SHAPEIT2	IMPUTE2	1000G Mar 2012	SNPTEST	GA, PC1	1.02/1.01
TDCOB-controls	ICE	95%	Heterozygosity, relatedness, ancestry outliers	95%	1x10 <sup>-6</sup>	MAF<1%	SHAPEIT2	IMPUTE2	1000G Mar 2012	SNPTEST	GA, PC1	1.02/1.05
YFS	I670	95%	Heterozygosity, relatedness, sex discrepancy, duplicates	95%	1x10 <sup>-6</sup>	MAF<1%	SHAPEIT	IMPUTE2	1000G Mar 2012	SNPTEST	PC1-4	0.99/1.01

(b) Component 2: UK Biobank

Study	Genotyping array(s) <sup>a</sup>	Sample quality control		SNP scaffold quality control			Prephasing software	Imputation		Association analysis		Lambda
		Call rate	Additional filters	Call rate	HWE <i>P</i> -value	Frequency		Software	Reference panel	Software	Covariates or adjustment	
UK Biobank	AUKBB	98%	Heterozygosity, relatedness, ancestry outliers	95%	N/A	MAF<1%	SHAPEIT2	IMPUTE2	HRC	BOLT-LMMv2.3	Sex, genotype array	N/A

(c) Component 3: Non-European ancestry GWAS.

Study	Genotyping array(s) <sup>a</sup>	Sample quality control		SNP scaffold quality control			Prephasing software	Imputation		Association analysis		Lambda (M/F)
		Call rate	Additional filters	Call rate	HWE P-value	Frequency		Software	Reference panel	Software	Covariates or adjustment	
CHOP-AA	I550, I610	95%	Relatedness, ancestry outliers, sex discrepancy	95%	1x10 <sup>-6</sup>	MAF<1%	SHAPEIT2	IMPUTE2	1000G Mar 2012	SNPTEST	PC1-3	0.98/0.98
CLHNS	ICM	98.6%	Relatedness, sex discrepancy	97%	1x10 <sup>-6</sup>	N/A	MaCH	MaCH	1000G Mar 2012	mach2qtl	GA	1.02/1.02
Generation R Turkish	I610, I660	97.5%	Heterozygosity, ancestry outliers, sex discrepancy	95%	1x10 <sup>-7</sup>	MAF<1%	MaCH	Minimac	1000G Mar 2012	mach2qtl	GA, PC1-4	1.01/1.02
Generation R Moroccan	I610, I660	97.5%	Heterozygosity, ancestry outliers, sex discrepancy	90%	1x10 <sup>-7</sup>	MAF<1%	MaCH	Minimac	1000G Mar 2012	mach2qtl	GA, PC1-4	1.01/0.98
Generation R Surinamese	I610, I660	97.5%	Heterozygosity, ancestry outliers, sex discrepancy	98%	1x10 <sup>-7</sup>	MAF<1%	MaCH	Minimac	1000G Mar 2012	mach2qtl	GA, PC1	0.99/0.95
HAPO-AC	IOQ	97%	Heterozygosity, relatedness, non-European ancestry, sex discrepancy, chromosomal anomalies	98%	1x10 <sup>-4</sup>	MAF<2%	IMPUTE2	IMPUTE2	1000G Mar 2012	R	GA, PC1-2, field centre	1.01/1.01
HAPO-MA	IOQ	97%	Heterozygosity, relatedness, non-European ancestry, sex discrepancy, chromosomal anomalies	98%	1x10 <sup>-4</sup>	MAF<2%	IMPUTE2	IMPUTE2	1000G Mar 2012	R	GA, PC1-2, field centre	0.99/0.98
HAPO-TH	IOQ	97%	Heterozygosity, relatedness, non-European ancestry, sex discrepancy, chromosomal anomalies	98%	1x10 <sup>-4</sup>	MAF<2%	IMPUTE2	IMPUTE2	1000G Mar 2012	R	GA, PC1-2, field centre	0.99/1.00
SCORM	I550	95%	Heterozygosity, relatedness, sex discrepancy	95%	1x10 <sup>-6</sup>	MAF<1%	SHAPEIT2	IMPUTE2	1000G Mar 2012	SNPTEST	GA	0.98/0.99

HWE, Hardy-Weinberg equilibrium; MAF, minor allele frequency; MAC, minor allele count; GA, gestational age; PC, principal component.

<sup>a</sup>Genotype array codes: Affymetrix 5.0 (A5); Affymetrix 6.0 (A6); Affymetrix Axiom UK BiLEVE (AUKBL); Affymetrix Axiom UK Biobank (AUKBB); Illumina Human370CNV (I370); Illumina HumanHap550 (I550); Illumina HumanHap610 (I610); Illumina HumanHap660 (I660); Illumina HumanHap670 (I670); Illumina CardioMetaboChip (ICM); Illumina OmniQuad (IOQ); Illumina OmniExpress (IOE); Illumina CoreExome (ICE); Illumina OmniExpressExome (IOEE).

**Supplementary Table 3. Description of studies contributing to trans-ancestry GWAS meta-analysis of offspring birth weight: ancestry group and country of origin, sample size, data collection methods, and birth weight summaries and exclusions.**

(a) Component 1: European ancestry GWAS

Study	Ancestry group	Country of origin	Year(s) of birth of offspring	Mean (SD) maternal age at delivery (year)	Sample size	Data collection	Phenotype exclusions	Mean (SD) birth weight (grams)	Median (IQR) GA (week) at delivery
1958 British Birth Cohort (B58C-WTCCC)	European	UK	1972-2000	26.2 (5.2)	858	Maternal self-report	Multiple births, GA <37 weeks, still birth, congenital anomalies	3325 (483)	40 (40-41)
1958 British Birth Cohort (B58C-T1DGC)	European	UK	1972-2000	26.1 (5.4)	836	Maternal self-report	Multiple births, GA <37 weeks, still birth, congenital anomalies	3379 (469)	40 (40-41)
ALSPAC <sup>a,b</sup> Mothers	European	UK	1991-1992	28.0 (5.0)	6,686	Identified from obstetric data, records from the ALSPAC measurers, and birth notification	Multiple births, GA <37 weeks, still birth, congenital anomalies	3468 (478)	40 (40-41)
DNBC-GOYA Random set	European	Denmark	1996-2002	29.2 (4.2)	1,805	Danish Medical Birth Register	Multiple births, GA <37 weeks, still birth, congenital anomalies	3643 (495)	40 (39-41)
DNBC-PTB-CONTROL Mothers	European	Denmark	1987-2009	29.9 (4.2)	1,656	Danish Medical Birth Register	Multiple births, GA <37 weeks, still birth, congenital anomalies	3595 (497)	40 (39-40)
EFSOCH Mothers	European	UK	2000-2004	30.5 (5.2)	855	Measured within 12 hours of birth	Multiple births, GA <37 weeks, still birth, congenital anomalies	3506 (472)	40 (37-43)
HAPO Mothers	Caucasian	Canada, UK, Australia	2000-2006	31.5 (5.3)	1,280	Medical record abstraction	Multiple births, GA <37 weeks, still birth, congenital anomalies	3557 (517)	40 (SD 1.7)
MoBa-2008 Mothers	European	Norway	1999-2008	28.5 (3.3)	650	Medical Birth Register of Norway	Multiple births, GA <37 weeks, still birth, congenital anomalies	3679 (430)	40 (SD 0.86)
NFBC1966	European	Finland	1987-2001	26.5 (3.7)	2,035	Birth Register Data	Multiple births, GA <37 weeks or unknown, still birth, congenital anomalies	3525 (461)	40 (SD 2)
NTR	European	Netherlands	1946-2003	27.1 (3.7)	707	Parental report or self-reported	Multiple births, GA <37 weeks, still birth, congenital anomalies	3469 (529)	40 (38-42)
QIMR	European	Australia	1929-1990	24.5 (4.0)	892	Self-report through questionnaire	Multiple births, still birth, congenital anomalies	3344 (532)	N/A
TWINSUK	European	UK	N/A	N/A	1,603	Questionnaire	Multiple births, still birth, congenital anomalies	N/A	N/A

(b) Component 2: UK Biobank (European only or All samples)

Study	Ancestry group	Country of origin	Year(s) of birth	Mean (SD) maternal age at delivery (year)	Sample size	Data collection	Phenotype exclusions	Mean (SD) birth weight (grams)	Median (IQR) GA (weeks) at delivery
UK Biobank	European	UK	1936-1970	25.3 (4.5)	190,406	Maternal self-report	Multiple births, birth weight <2200g or >4600g	3227.1 (477)	N/A
UK Biobank	ALL	UK	1936-1970	25.3 (4.6)	210,208	Maternal self-report	Multiple births, birth weight <2200g or >4600g	3218.5 (478)	N/A

M, Males; F, Females; GA, gestational age; IQR, interquartile range; N/A, not applicable; SD, standard deviation.

Replication data for 18 SNPs collected from the following studies were used in the previous Maternal GWAS paper (Beaumont RB, Warrington NM et al. 2018): Berlin Berth Cohort Mothers (N=1,319), CHOP Mothers (N=312), COPSAC-2000 Mothers (N=282), FHS Mothers (N=1,118), GEN-3G Mothers (N=685), Generation R Mothers (N=3,187), HAPO Mothers (non-GWAS, N=3,701), INMA Mothers (N=1,525), NCCGP Mothers (N=1,113), RAINE Mothers (N=1,337), RHEA Mothers (N=970) and SWS Mothers (N=1,928). These data were not combined in the current meta-analysis, but meta-analysis results including these 12,129 individuals for the 2 signals (out of 18) that achieved  $p < 5 \times 10^{-8}$  are included in the footnote of Supplementary Table 5

<sup>a</sup>Fraser A, Macdonald-Wallis C, Tilling K, Boyd A et al. Cohort Profile: the Avon Longitudinal Study of Parents and Children: ALSPAC mothers cohort. *Int J Epidemiol* 42, 97-110 (2013).

<sup>b</sup>The study website contains details of all the data that is available through a fully searchable data dictionary (<http://www.bris.ac.uk/alspac/researchers/data-access/data-dictionary/>).

**Supplementary Table 4. Description of studies contributing to trans-ancestry GWAS meta-analysis of offspring birth weight: genotyping, quality control, pre-phasing, imputation, and association analysis.**

(a) Component 1: European ancestry GWAS

Study	Genotyping array(s) <sup>a</sup>	Sample quality control		SNP scaffold quality control			Imputation		Association analysis		Lambda
		Call rate	Additional filters	Call rate	HWE P-value	Frequency	Software	Reference panel	Software	Covariates or adjustment	
1958 British Birth Cohort or NDCCS (B58C-WTCCC)	A6	None	Relatedness, ancestry outliers, sex discrepancy, identity, channel contrast	98%	1x10 <sup>-20</sup>	MAF<1%	IMPUTE2	HapMap Phase II	SNPTEST	Sex, GA	0.984
1958 British Birth Cohort or NDCCS (B58C-T1DGC)	I550	97%	Heterozygosity, ancestry outliers, sex discrepancy	95%	1x10 <sup>-7</sup>	MAF<1%	IMPUTE2	HapMap Phase II	SNPTEST	Sex, GA	1.007
ALSPAC Mothers	I660	95%	Heterozygosity, ancestry outliers, identity	95%	1x10 <sup>-7</sup>	MAF<1%	MaCH	HRC	SNPTEST	Sex, GA, PC	1.003
DNBC-GOYA Random set	I610	95%	Heterozygosity, ancestry outliers, sex discrepancy	95%	1x10 <sup>-7</sup>	MAF<1%	MaCH	HapMap Phase II	mach2qtl	Sex, GA	1.006
DNBC-PTB-CONTROL Mothers	I660	95%	Ancestry outliers, sex discrepancy, Mendelian inconsistency	98%	1x10 <sup>-3</sup>	MAF<1%	MaCH	HapMap Phase II	mach2qtl	Sex, GA	1.006
EFSOCH Mothers	ICE	98%	Ancestry outliers, sex discrepancy	95%	1x10 <sup>-6</sup>	MAF<1%	MaCH	HRC	SNPTEST	Sex, GA, PC	1.003
HAPO Mothers	I610	95%	Heterozygosity, non-European ancestry, sex discrepancy	98%	1x10 <sup>-4</sup>	MAF<2%	Beagle	HapMap Phase III	SNPTEST	Sex, GA, PC, field centre	1.016
MoBa-2008 Mothers	I660	98%	Ancestry outliers, sex discrepancy	95%	1x10 <sup>-6</sup>	MAF<5%	PLINK v.1.07	HapMap Phase II	SNPTEST	Sex, GA	N/A
NFBC1966	I370	95%	Heterozygosity, relatedness, ancestry outliers, sex discrepancy, duplicates, withdrawn consent	95% (99% if MAF<5%)	5.7x10 <sup>-7</sup>	MAF<1%	IMPUTE2	HapMap Phase II	SNPTEST	Sex, GA, PC	1.02
NTR	A6, I370, I660, IOQ	90%	Heterozygosity	95%	1x10 <sup>-5</sup>	MAF<1%	IMPUTE1	HapMap Phase II	SNPTEST	Sex, GA, array, PC	1.002
QIMR	I370	95%	Relatedness, ancestry outliers, sex discrepancy, Mendelian inconsistency	95%	1x10 <sup>-6</sup>	MAF<1%	MaCH	HapMap Phase II	MERLIN	Sex	1.012
TWINSUK	I300, I1M, I1.2M	98%	Heterozygosity, ancestry outliers, identity	97% (99% if MAF<5%)	1x10 <sup>-6</sup>	MAF<1%	IMPUTE2	HapMap Phase II	SNPTEST	Sex	1.00



(b) Component 2: UK Biobank

Study	Genotyping array(s) <sup>a</sup>	Sample quality control		SNP scaffold quality control			Prephasing software	Imputation		Association analysis		Lambda
		Call rate	Additional filters	Call rate	HWE <i>P</i> -value	Frequency		Software	Reference panel	Software	Covariates or adjustment	
UK Biobank	AUKBB	98%	Heterozygosity, relatedness, ancestry outliers	95%	N/A	MAF<1%	SHAPEIT2	IMPUTE2	HRC	BOLT-LMMv2.3	Sex, genotype array	N/A

HWE, Hardy-Weinberg equilibrium; MAF, minor allele frequency; MAC, minor allele count; GA, gestational age; PC, principal component.

<sup>a</sup>Genotype array codes: Affymetrix 5.0 (A5); Affymetrix 6.0 (A6); Affymetrix Axiom UK BiLEVE (AUKBL); Affymetrix Axiom UK Biobank (AUKBB); Illumina HumanHap300 (I300); Illumina Human370CNV (I370); Illumina HumanHap550 (I550); Illumina HumanHap610 (I610); Illumina HumanHap660 (I660); Illumina HumanHap670 (I670); Illumina Human1M-Duo (I1M); Illumina Human1.2MDuo 1M (I1.2MD); Illumina CardioMetaboChip (ICM); Illumina OmniQuad (IOQ); Illumina OmniExpress (IOE); Illumina CoreExome (ICE); Illumina OmniExpressExome (IOEE).

**Supplementary Table 16: Results from linear regression analyses assessing the association between offspring birth weight and maternal non-transmitted allele score, maternal transmitted (or shared) allele score or paternal transmitted allele score for adult height, glycaemic traits and blood pressure in 4,962 mother-child pairs from the ALSPAC study.** The SNPs used to generate the weighted allele scores are shown in Supplementary Table 14.

Exposure	Outcome <sup>a</sup>	Score	Beta <sup>b</sup>	Standard Error	P-value
Height	Birth Weight	Maternal non-transmitted	0.043	0.029	0.139
		Maternal transmitted/Shared	0.263	0.030	2.58E-18
		Paternal transmitted	0.190	0.029	1.12E-10
Fasting Glucose	Birth Weight	Maternal non-transmitted	0.641	0.188	0.001
		Maternal transmitted/Shared	0.326	0.187	0.081
		Paternal transmitted	-0.103	0.185	0.576
Insulin Secretion <sup>c</sup>	Birth Weight	Maternal non-transmitted	-0.131	0.097	0.178
		Maternal transmitted/Shared	-0.193	0.100	0.054
		Paternal transmitted	-0.048	0.098	0.629
Insulin Sensitivity <sup>d</sup>	Birth Weight	Maternal non-transmitted	0.262	0.248	0.290
		Maternal transmitted/Shared	0.273	0.251	0.278
		Paternal transmitted	0.204	0.244	0.403
SBP	Birth Weight	Maternal non-transmitted	-0.016	0.008	0.041
		Maternal transmitted/Shared	-0.014	0.008	0.076
		Paternal transmitted	-0.014	0.008	0.080
DBP	Birth Weight	Maternal non-transmitted	-0.026	0.012	0.036
		Maternal transmitted/Shared	-0.038	0.013	0.003
		Paternal transmitted	-0.010	0.013	0.446

<sup>a</sup> Birth weight effect sizes were converted from SD units to grams using 484g to represent 1 SD in birth weight (Freathy *et al.* 2010; <https://www.nature.com/articles/ng.567>)

<sup>b</sup> Birth weight effect sizes are reported in grams per weighted allele

<sup>c</sup> Disposition index of insulin secretion calculated from oral glucose tolerance test (OGTT) results as Corrected Insulin Response x 10,000 /  $\sqrt{\text{Fasting Plasma Glucose} \times \text{Fasting Insulin} \times \text{Mean Glucose during OGTT} \times \text{Mean Insulin During OGTT}}$ . Full details are presented in <http://journals.plos.org/plosgenetics/article?id=10.1371/journal.pgen.1004235>

<sup>d</sup> Insulin sensitivity is calculated as fasting insulin adjusted for body mass index (BMI)

**Supplementary Table 18: Results from linear regression analyses assessing the association between maternal, paternal or offspring allelic scores of birth weight (a) or systolic blood pressure (b) associated SNPs and offspring systolic blood pressure (SBP), without and with adjustment for offspring SNPs, in 3,886 mother-offspring pairs and 1,749 father-offspring pairs from the UK Biobank.**

**a) Birth weight associated SNPs**

			205 autosomal SNPs			72 autosomal SNPs with maternal effect			31 autosomal SNPs with only maternal effect		
Outcome	Analysis sample	Exposure	Beta	Standard Error	P-value	Beta	Standard Error	P-value	Beta	Standard Error	P-value
Maternal SBP	Mother/offspring pairs (N=3,886)	Maternal allele score	-0.060	0.035	0.084	-0.061	0.059	0.300	-0.196	0.099	0.046
Paternal SBP	Father/offspring pairs (N=1,749)	Paternal allele score	-0.087	0.050	0.084	-0.150	0.087	0.085	-0.140	0.144	0.330
Offspring SBP	Mother/offspring pairs (N=3,886)	Maternal allele score	0.025	0.025	0.319	0.063	0.043	0.140	0.062	0.072	0.388
		Maternal allele score, adjusted for offspring SNPs	0.043	0.030	0.152	0.117	0.050	0.018	0.213	0.083	0.011
		Offspring allele score	-0.009	0.026	0.722	-0.056	0.044	0.200	-0.173	0.073	0.018
	Father/offspring pairs (N=1,749)	Offspring allele score, adjusted for maternal SNPs	-0.025	0.030	0.411	-0.110	0.050	0.029	-0.283	0.085	8.13E-04
		Paternal allele score	0.022	0.037	0.545	0.000	0.064	0.998	-0.158	0.106	0.138
		Paternal allele score, adjusted for offspring SNPs	0.032	0.044	0.459	0.091	0.075	0.221	0.029	0.125	0.820
		Offspring allele score	-0.011	0.038	0.772	-0.106	0.063	0.094	-0.246	0.102	0.016
		Offspring allele score, adjusted for paternal SNPs	-0.011	0.045	0.802	-0.132	0.074	0.075	-0.259	0.120	0.031

Beta values are in mmHg per birth weight-raising allele

**b) SBP associated SNPs**

			68 SNPs		
Outcome	Analysis sample	Exposure	Beta	Standard Error	P-value
Maternal SBP	Mother/offspring pairs (N=3,886)	Maternal allele score	0.335	0.065	2.71E-07
Paternal SBP	Father/offspring pairs (N=1,749)	Paternal allele score	0.346	0.091	1.37E-04
Offspring SBP	Mother/offspring pairs (N=3,886)	Maternal allele score	0.135	0.048	0.005
		Maternal allele score, adjusted for offspring SNPs	0.007	0.055	0.903
		Offspring allele score	0.254	0.047	5.25E-08
		Offspring allele score, adjusted for maternal SNPs	0.245	0.054	4.97E-06
	Father/offspring pairs (N=1,749)	Paternal allele score	0.177	0.067	0.008
		Paternal allele score, adjusted for offspring SNPs	0.079	0.080	0.319
		Offspring allele score	0.250	0.067	1.74E-04
		Offspring allele score, adjusted for paternal SNPs	0.225	0.078	0.004

Beta values are in mmHg per birth weight-raising allele

## **Supplementary Note 1: Supplementary Methods**

### **Genome-wide association analysis in the Early Growth Genetics (EGG) consortium**

#### ***Own birth weight***

Studies from the EGG Consortium conducted genome-wide association analysis of own birth weight that was Z-score transformed separately in males and females, and adjusted for study-specific covariates, including gestational duration, where available (**Supplementary Table 1**). This included 35 studies with 80,745 individuals of European ancestry and an additional nine studies with 12,948 individuals of diverse ancestry groups (**Supplementary Figure 1**). GWASs were imputed up to the 1000 Genomes<sup>7</sup> (1000G) reference panel. We combined the sex-specific birth weight association summary statistics across the EGG studies in a fixed-effects meta-analysis, implemented in GWAMA<sup>8</sup>.

#### ***Offspring birth weight***

Studies from the EGG Consortium conducted genome-wide association analysis on offspring birth weight that was Z-score transformed, and adjusted for sex, gestational duration and ancestry informative principal components where necessary (**Supplementary Table 3**). This included 10 studies with 12,319 individuals of European descent that were imputed up to the HapMap 2 reference panel and an additional two studies with 7,542 individuals of European descent imputed up to the HRC reference panel (**Supplementary Figure 2**). We combined the birth weight association summary statistics across the 10 HapMap 2 imputed EGG studies in a fixed-effects meta-analysis, implemented in GWAMA<sup>8</sup>.

### **UK Biobank phenotype preparation for genome-wide association analyses**

The UK Biobank is a study of 502,655 participants<sup>9</sup>. A total of 280,315 participants reported their own birth weight in kilograms at either the baseline visit or at least one of the follow-

up visits. Participants reporting being part of a multiple birth were excluded from our analyses (N=7,706). For participants reporting birth weight at more than one visit (N=11,214), the mean value of the reported birth weights was used, and if the mean difference between any 2 time points was >1kg, the participant was excluded (N=74). Data on gestational duration were not available; however, in order to exclude likely pre-term births, participants with birth weight values <2.5kg or >4.5kg were excluded (N=36,330). The remaining birth weight values were Z-score transformed separately in males and females for analysis.

Female participants were also asked to report the birth weight of their first child. A total of 216,839 women reported the birth weight of their first child on at least one assessment center visit. Values were recorded to the nearest whole pound, and were converted to kilograms for our analyses. Where women reported the birth weight of the first child at multiple time points (N=11,353) these were averaged and women were excluded if the mean difference between any two offspring birth weight measurements was >1kg (N=31). Women who reported the birth weight of their first child <2.2kg or >4.6kg were excluded (N=6,333). Birth weight of first child was regressed against age at first birth and assessment center location. Residuals from the regression model were converted to Z-scores for analysis (sex of the first child was not available, so we were unable to calculate sex-specific Z-scores).

### **UK Biobank ethnicity classification and genome-wide association analysis**

We analysed data from the May 2017 release of imputed genetic data from the UK Biobank, a resource extensively described elsewhere<sup>9</sup>. Given the reported technical error with non-

HRC imputed variants, we focused exclusively on the set of ~40M imputed variants from the HRC reference panel.

In addition to the quality control metrics performed centrally by the UK Biobank, we defined a subset of “white European” ancestry samples. To do this, we generated ancestry informative principal components (PCs) in the 1000 genomes samples. The UK Biobank samples were then projected into this PC space using the SNP loadings obtained from the principal components analysis using the 1000 genomes samples. The UK Biobank participants’ ancestry was classified using K-means clustering centred on the three main 1000 genomes populations (European, African, and South Asian). Those clustering with the European cluster were classified as having European ancestry. The UK Biobank participants were asked to report their ethnic background. Only those reporting as either “British”, “Irish”, “White” or “Any other white background” were included in the clustering analysis. In total, 217,397 participants with a valid measure of their own birth weight and 190,406 women with a valid measure of birth weight of first child were classified as European and included in analyses. For trans-ethnic analyses all participants with valid phenotypes were included regardless of ancestry (N=227,530 participants with a valid measure of their own birth weight and N=210,208 with a valid measure of the birth weight of their first child). Association analysis was conducted using a linear mixed model implemented in BOLT-LMM v2.3<sup>10</sup> to account for population structure and relatedness. Only autosomal genetic variants which were common (MAF>1%), passed QC in all 106 batches and were present on both genotyping arrays were included in the genetic relationship matrix (GRM). For the genome-wide association study (GWAS) of the participants’ own birth weight, genotyping array and year of birth were included as covariates in all models. For the GWAS of the birth weight of the first child, genotyping array and genotyping release (interim vs. full) were included as

covariates in the regression model, and indels, regions of long range LD (as defined in <sup>9</sup>) and SNPs with Hardy-Weinberg equilibrium P-values < 1x10<sup>-6</sup> were excluded from the GRM.

### **Sensitivity analyses for genome-wide association meta-analyses**

After conducting meta-analyses to combine the results from the EGG consortium and the UK Biobank, we conducted a series of sensitivity analyses to ensure that our results were accurate. Firstly, we were concerned that self-reported birth weight as adults in the UK Biobank would not be comparable with that obtained from more stringent collection methods used in the EGG studies. We conducted a heterogeneity test using Cochran's Q statistic<sup>11</sup>, as implemented in GWAMA<sup>8</sup>, to assess the difference in allelic effects between the EGG meta-analysis and the UK Biobank. We acknowledge that the power to detect evidence for heterogeneity using the Cochran's Q statistic when comparing two groups is low and we use it here to highlight any SNPs with large differences in allelic effects. For the European meta-analysis of own birth weight, we were unable to detect evidence of heterogeneity at lead SNPs after Bonferroni correction (all P > 0.004; **Supplementary Table 5**); however, there was an enrichment for low P, with almost double the expected number of SNPs with P < 0.05 (13/131; Supplementary Table 5). For the trans-ethnic meta-analysis of own birth weight, the one additional lead SNP did not show evidence of heterogeneity in birth weight allelic effects across the three components after Bonferroni correction (Cochran's Q P = 0.714; **Supplementary Table 5**). For both the European and trans-ethnic meta-analyses of offspring birth weight, there was no evidence of heterogeneity in birth weight allelic effects at any of the lead SNPs, after Bonferroni correction (Cochran's Q P > 0.05), between the UK Biobank and EGG studies and there was no enrichment for low P (**Supplementary Table 5**).



Secondly, the UK Biobank lacked information on gestational duration, which could impact the strength of association compared to the results obtained from the EGG studies that adjusted for gestational duration. Therefore, we conducted a further sensitivity analysis of the meta-analysis of own birth weight to specifically assess the impact of adjustment for gestational duration testing for heterogeneity in allelic effects at lead SNPs between EGG studies which adjusted for gestational duration (N=43,964) and the European subset of the UK Biobank. The only locus where the lead SNP showed significant heterogeneity, after Bonferroni correction, was rs1482852 at the LOC339894/CCNL1 signal ( $P_{\text{het}}=0.00015$ ), which was a locus showing the strongest association with own birth weight and genome-wide significant in both EGG and the UK Biobank components independently.

Thirdly, there is potential for individuals to be in both the UK Biobank and EGG studies (i.e. the same individual in both the UK Biobank and a study within EGG) and this might lead to false positive association signals. We performed a bivariate linkage-disequilibrium (LD) score regression<sup>12</sup> analysis using the European UK Biobank GWAS and European EGG meta-analysis summary statistics of own birth weight, and observed a regression intercept of 0.0266 (0.0077), indicating that the equivalent of approximately 3,524 individuals were in both GWAS analyses. Bivariate LD score regression<sup>12</sup> using the European UK Biobank GWAS and European EGG meta-analysis summary statistics of offspring birth weight, we observed a regression intercept of 0.0165 (0.0063), indicating that the equivalent of approximately 1,015 individuals were in both the EGG and UK Biobank GWAS analyses of offspring birth weight.

## **Structural equation model for estimating adjusted maternal and fetal effects of the genome-wide significant variants**

The structural equation modelling (SEM) approach used to estimate adjusted maternal and fetal effects has been described elsewhere<sup>13</sup>. Briefly, to estimate the parameters for the SEM-adjusted fetal and maternal effects on birth weight, we use three observed variables available in the UK Biobank; the participant's genotype, their own self-reported birth weight, and in the case of the UK Biobank women, the birth weight of their first child (**Supplementary Figure 6a**). Additionally, the model comprises two latent (unobserved) variables, one for the genotype of the UK Biobank participant's mother and one for the genotype of the participant's offspring. From biometrical genetics theory, these latent genetic variables are correlated 0.5 with the participant's own genotype, so we fix the path coefficients between the latent and observed genotypes to be 0.5. Participants who only report their own birth weight (including males), contribute directly to estimation of the fetal effect of genotype on birth weight and also indirectly to estimation of the maternal effect on birth weight since their observed genotype is correlated with their mother's unmeasured latent genotype at the same locus. Similarly, summary statistics from the EGG meta-analysis of the unadjusted fetal effect (i.e. the European GWAS meta-analysis of own birth weight) can be incorporated into the model in this manner. Participants who report only their offspring's birth weight (including mother's reporting birth weight of their male offspring), contribute directly to estimation of the maternal effect on birth weight and indirectly to the estimate of the fetal effect on birth weight, since their observed genotype is correlated with their offspring's latent genotype at the same locus. Again, summary statistics from the EGG meta-analysis of the unadjusted maternal effect (i.e. the European GWAS meta-analysis of offspring birth weight) can be incorporated into the model this way. These five components

are fit to the five subsets of data (i.e. the UK Biobank participants with complete data, the UK Biobank participants with their own birth weight and genotype data only, EGG summary statistics for the unadjusted fetal effect of genotype on birth weight, the UK Biobank participants with their offspring's birth weight and maternal genotype only and EGG summary statistics for the unadjusted maternal effect of genotype on birth weight) and then the likelihoods from each subset are combined. In addition to fitting the SEM to estimate the SEM-adjusted maternal and fetal effects, we fit a second model constraining the maternal and fetal effects to be zero and conducted a two degree of freedom Wald test to assess any effect of the SNP on birth weight. There is likely to be measurement error in the birth weight data in the UK Biobank, as well as some of the EGG studies, due to difficulty recalling birth weight. Additionally, the women in UK Biobank were asked to recall their offspring birth weight to the nearest pound. We have shown using simulations that both random measurement error (for example, due to difficulty in recall) and measurement error in offspring birth weight due to rounding to the nearest pound do not have a substantial influence on the estimation of either the maternal or fetal effects (see Warrington et al. <sup>13</sup>). We therefore do not think that the imprecision of the UK Biobank birth weight data will substantially influence the results of downstream analyses.

**Structural equation model (SEM) for estimating adjusted maternal and fetal effects on genome-wide significant variants on the X chromosome: Supplementary Figure 6A** displays the SEM that was fit to data on the genome-wide significant subset of SNPs from the autosomes to estimate the maternal and fetal effect on birth weight. The three observed variables displayed in boxes in the path diagram (**Supplementary Figure 6a**) represent the birth weight of the individual (BW), the birth weight of their offspring (BW<sub>O</sub>) and the

genotype of the individual (SNP). The two variables in circles represent the unobserved latent genotypes of the individual's mother ( $G_G$ ) and their offspring ( $G_O$ ). The total variance of these latent genotypes are set to  $\Phi$ , the variance of the observed SNP (i.e.  $\text{var}(G_G) = \Phi$ ;  $\text{var}(\text{SNP}) = 0.5^2\Phi + 0.75\Phi$ ;  $\text{var}(G_O) = 0.5^2\Phi + 0.75\Phi$ ). The  $\hat{\beta}_{f_{adj}}$  and  $\hat{\beta}_{m_{adj}}$  path coefficients refer respectively to the adjusted fetal and maternal effects of the genotypes on birth weight. The residual error terms for the birth weight of the individual and their offspring are represented by  $\epsilon$  and  $\epsilon_o$  respectively. The covariance between the residual error terms is given by  $\rho$ .

However, for the genome-wide significant SNPs on the X chromosome a slightly different model was fit to the data due to males having twice the expected genetic variance at X linked loci compared to females. For example, if  $SNP_f$  denotes the genotypic effect of the SNP in females (i.e. 0, 1 or 2) and  $SNP_m$  denotes the genotypic effect of the SNP in males (i.e. 0 or 2), and  $p$  represents the increaser allele frequency, then:

$$\begin{aligned}
 E(SNP_f) &= 2p(1 - p) + 2p^2 \\
 &= 2p(1 - p + p) \\
 &= 2p \\
 E(SNP_f^2) &= 2p(1 - p) + 4p^2 \\
 &= 2p(1 - p + 2p) \\
 &= 2p(1 + p) \\
 \text{Var}(SNP_f) &= E(SNP_f^2) - [E(SNP_f)]^2 \\
 &= 2p(1 + p) - [2p]^2 \\
 &= 2p + 2p^2 - 4p^2 \\
 &= 2p(1 - p)
 \end{aligned}$$

$$E(SNP_m) = 2p$$

$$E(SNP_m^2) = 4p$$

$$\begin{aligned} Var(SNP_m) &= E(SNP_m^2) - [E(SNP_m)]^2 \\ &= 4p - [2p]^2 \\ &= 4p(1 - p) \end{aligned}$$

Therefore, we fit the SEM displayed in **Supplementary Figure 6a** to the X chromosome SNPs in the UK Biobank females that reached genome-wide significance. For the males in the UK Biobank, we fit the SEM displayed in **Supplementary Figure 6b** to account for the increased SNP variance. Parameters were constrained equal across the models, and the likelihoods jointly maximized to get an overall estimate of the maternal and fetal effects on birth weight at these SNPs.

Although we do not know the sex of the UK Biobank women's offspring (since this information was not recorded in the UK Biobank), fitting the model using  $0.75\Phi$  or  $1.75\Phi$  for the variance of the offspring's latent genotype did not produce a change to estimates of the maternal and fetal effects (to four decimal places).

**Derivation of the linear approximation of the SEM for genome-wide analyses:** The SEM is computationally intensive to fit via maximum likelihood, making it difficult to run the model on all SNPs across the genome. Therefore, we developed an approximation of the SEM using a linear transformation and ordinary least squares linear regression. Using path tracing rules<sup>14</sup> for the full path diagram (**Supplementary Figure 6a**), we can show that:

$$\begin{aligned} var(SNP) &= \phi \\ cov(BW, SNP) &= \phi \left( \beta_{f_{adj}} + \frac{1}{2} \beta_{m_{adj}} \right) \end{aligned}$$

$$\text{cov}(BW_O, SNP) = \phi \left( \beta_{m_{adj}} + \frac{1}{2} \beta_{f_{adj}} \right)$$

If we let  $\hat{\beta}_{f_{unadj}}$  and  $\hat{\beta}_{m_{unadj}}$  be the unadjusted fetal and maternal effect estimates respectively and  $\hat{\beta}_{f_{adj}}$  and  $\hat{\beta}_{m_{adj}}$  be the adjusted fetal and maternal effect estimates respectively (as denoted in **Supplementary Figure 6a**), then we can derive the adjusted estimates from the unadjusted estimates using the following calculation:

$$\begin{aligned} \hat{\beta}_{f_{unadj}} &= \frac{\text{cov}(BW, SNP)}{\text{var}(SNP)} \\ &= \frac{\hat{\phi} \left( \hat{\beta}_{f_{adj}} + \frac{1}{2} \hat{\beta}_{m_{adj}} \right)}{\phi} \end{aligned}$$

$$= \hat{\beta}_{f_{adj}} + \frac{1}{2} \hat{\beta}_{m_{adj}}$$

$$\begin{aligned} \hat{\beta}_{m_{unadj}} &= \frac{\text{cov}(BW_O, SNP)}{\text{var}(SNP)} \\ &= \frac{\hat{\phi} \left( \hat{\beta}_{m_{adj}} + \frac{1}{2} \hat{\beta}_{f_{adj}} \right)}{\phi} \end{aligned}$$

$$= \hat{\beta}_{m_{adj}} + \frac{1}{2} \hat{\beta}_{f_{adj}}$$

$$\text{Therefore: } \hat{\beta}_{m_{adj}} = 2 \left( \hat{\beta}_{f_{unadj}} - \hat{\beta}_{f_{adj}} \right) = \hat{\beta}_{m_{unadj}} - \frac{1}{2} \hat{\beta}_{f_{adj}}$$

$$-2\hat{\beta}_{f_{adj}} + \frac{1}{2}\hat{\beta}_{f_{adj}} = \hat{\beta}_{m_{unadj}} - 2\hat{\beta}_{f_{unadj}}$$

$$-\frac{3}{2}\hat{\beta}_{f_{adj}} = \hat{\beta}_{m_{unadj}} - 2\hat{\beta}_{f_{unadj}}$$

$$\hat{\beta}_{f_{adj}} = -\frac{2}{3}\hat{\beta}_{m_{unadj}} + \frac{4}{3}\hat{\beta}_{f_{unadj}} \quad (1)$$

$$\text{And: } \hat{\beta}_{m_{adj}} = \hat{\beta}_{m_{unadj}} - \frac{1}{2}\hat{\beta}_{f_{adj}}$$

$$= \hat{\beta}_{m_{unadj}} - \frac{1}{2} \left( -\frac{2}{3}\hat{\beta}_{m_{unadj}} + \frac{4}{3}\hat{\beta}_{f_{unadj}} \right)$$

$$\begin{aligned}
&= \hat{\beta}_{m_{unadj}} + \frac{1}{3}\hat{\beta}_{m_{unadj}} - \frac{2}{3}\hat{\beta}_{f_{unadj}} \\
&= \frac{4}{3}\hat{\beta}_{m_{unadj}} - \frac{2}{3}\hat{\beta}_{f_{unadj}}
\end{aligned} \tag{2}$$

And the standard errors for the adjusted estimates are

$$\begin{aligned}
var(\hat{\beta}_{f_{adj}}) &= var\left(-\frac{2}{3}\hat{\beta}_{m_{unadj}} + \frac{4}{3}\hat{\beta}_{f_{unadj}}\right) \\
&= var\left(-\frac{2}{3}\hat{\beta}_{m_{unadj}}\right) + var\left(\frac{4}{3}\hat{\beta}_{f_{unadj}}\right) \\
&= \frac{4}{9}var(\hat{\beta}_{m_{unadj}}) + \frac{16}{9}var(\hat{\beta}_{f_{unadj}}) \\
SE(\hat{\beta}_{f_{adj}}) &= \sqrt{\frac{4}{9}var(\hat{\beta}_{m_{unadj}}) + \frac{16}{9}var(\hat{\beta}_{f_{unadj}})}
\end{aligned} \tag{3}$$

$$\begin{aligned}
var(\hat{\beta}_{m_{adj}}) &= var\left(\frac{4}{3}\hat{\beta}_{m_{unadj}} - \frac{2}{3}\hat{\beta}_{f_{unadj}}\right) \\
&= \frac{16}{9}var(\hat{\beta}_{m_{unadj}}) + \frac{4}{9}var(\hat{\beta}_{f_{unadj}}) \\
SE(\hat{\beta}_{m_{adj}}) &= \sqrt{\frac{16}{9}var(\hat{\beta}_{m_{unadj}}) + \frac{4}{9}var(\hat{\beta}_{f_{unadj}})}
\end{aligned} \tag{4}$$

The independence of the unadjusted estimates for the fetal and maternal effect are guaranteed in our case because the regressions are performed on different subsets of individuals. If the model is truly linear, then the same estimates can be obtained by transforming the reported birth weights rather than the regression coefficients<sup>15</sup>.

**Supplementary Figure 18** outlines the analysis pipeline undertaken to estimate the adjusted maternal and fetal effects on birth weight, incorporating both the UK Biobank data and the summary statistics from the EGG meta-analysis. First, we grouped the European subset of the UK Biobank data into three subsets; 1) participants who reported both their own birth

weight and the birth weight of their offspring (N=101,541), 2) participants who only reported their own birth weight (N=115,070), and 3) participants who only reported their offspring's birth weight in the UK Biobank (N=88,846). The UK Biobank sample sizes used in this analysis are larger than those used in the SEM as the GWAS analyses are conducted in BOLT-LMM and can therefore account for the complex cryptic relationships between individuals and population structure. Similar to the SEM analyses, birth weight Z-scores in the UK Biobank participants were calculated from residuals of a regression model adjusting for sex (own birth weight only) and assessment centre, after the same exclusions were made as in the GWAS.

For the UK Biobank participants in the first subset with both birth weight measures, we could combine their own and their offspring's birth weight to create two new outcome variables that were used to directly estimate the adjusted fetal and maternal effects in a GWAS. Instead of using the raw birth weight measures to calculate the combined measures, we used the Z-scores that were used in the GWAS of own birth weight (which were adjusted for sex and assessment center) and offspring birth weight (which were adjusted for assessment center). We then conducted the GWAS analysis in BOLT-LMM<sup>10</sup>, adjusting for genotyping chip, to estimate the adjusted fetal and maternal effects at each SNP.

For the UK Biobank participants in the second subset with only their own birth weight, we conducted a GWAS analysis in BOLT-LMM<sup>10</sup> adjusting for chip, of birth weight z-scores that were adjusted for sex and assessment center. We then meta-analysed these results with the results of the meta-analysis of the fetal effect from the EGG consortium using a fixed-effects, inverse-variance weighted meta-analysis in METAL<sup>16</sup> to get a combined estimate of



the unadjusted fetal effect ( $\hat{\beta}_{f_{unadj}}$ ). We used the same procedure for the third subset of the UK Biobank participants with only their offspring's birth weight, and combined their results with the meta-analysis of the maternal effect from the EGG consortium to get a combined estimate of the unadjusted maternal effect ( $\hat{\beta}_{m_{unadj}}$ ). To get the adjusted maternal and fetal effect estimates, we combined the meta-analysis results of the unadjusted maternal and fetal effects for each SNPs using equations (1) and (2) and their corresponding standard errors from equations (3) and (4). Finally, we conducted another fixed effects, inverse-variance weighted meta-analysis to combine the adjusted maternal and fetal effect estimates from the UK Biobank participants with both birth weight measures and the combined adjusted effect estimates from the UK Biobank and EGG meta-analysis.

To check whether this linear approximation gave similar results as the full SEM, we compared  $\hat{\beta}_{f_{adj}}$  and  $\hat{\beta}_{m_{adj}}$  and their corresponding standard errors for the subset of genome-wide significant SNPs that we conducted the full SEM on. **Supplementary Figure 9** shows that there was very good concordance between the full SEM and this linear approximation for both the effect estimates and the standard errors. The standard errors are slightly larger for the full SEM due to the exclusion of related individuals from the analysis resulting in a smaller sample size.

The advantages of this linear transformation include its computational efficiency, especially when you only have individuals with both their own and their offspring's birth weights, and ability to use available GWAS software such as BOLT-LMM<sup>10</sup> that accounts for relatedness

between individuals. However, when using only summary statistics from previous GWAS analyses, where it is unknown how many individuals have contributed to both analyses (i.e. there is some sample overlap between the GWAS of own birth weight and the GWAS of offspring birth weight), the estimates from this linear approximation may be biased. Therefore, we recommend using the SEM for more complex data structures such as this as the degree of sample overlap can be estimated using LD score regression<sup>12</sup> and then the SEM likelihood can be weighted appropriately to take into account the overlap.

### **Phenotype preparation for the UK Biobank traits used in BOLT-LMM analysis estimating the covariance between birth weight and adult traits**

**Height:** standing and sitting height were measured in cm. Participants were excluded if height was more than 4.56SD from the mean and sitting height-to-standing height ratio was greater than 0.75. **Body mass index (BMI):** BMI was calculated from weight (kg)/height<sup>2</sup> (m<sup>2</sup>). **Obesity & Morbid Obesity:** normal weight was classified as  $18.5 \leq \text{BMI} < 25$ , obese  $30 \leq \text{BMI} < 35$  and morbid obese  $35 \leq \text{BMI}$ . Normal weight was used as the control group for obesity and morbid obesity phenotypes. **Waist Circumference, Hip Circumference and Waist-Hip Ratio (WHR):** waist and hip circumference were measured at the UK Biobank assessment center visits. WHR was calculated from these measures and adjusted for BMI in analyses. **SBP & DBP:** two blood pressure readings were taken in the UK Biobank, approximately 5 minutes apart, and two valid readings were available for most participants. An average of these was calculated, excluding individuals where the two readings differed by more than 4.56SD. In participants where only one valid blood pressure was available, this was used. Blood pressure measurements more than 4.56D away from the mean were excluded. Blood pressure medication use was accounted for by adding 10 and 15 to diastolic

(DBP) and systolic (SBP) measures respectively. **Type 2 diabetes (T2D):** participants in the UK Biobank were asked about which cancer and non-cancer illnesses they suffered from. Individuals were classified as having T2D if they reported either T2D or generic diabetes to these questions. Participants were excluded if they reported using insulin within 1 year of diagnosis, or if they reported being diagnosed under the age of 35 or with no known age of diagnosis. Participants diagnosed within the preceding year were also excluded, as we were unable to determine whether they used insulin within this time frame. **Coronary artery disease (CAD):** CAD was defined from the non-cancer illnesses questions. Participants reporting angina and/or heart attack at the interview stage were excluded from CAD cases. Controls were participants without these conditions. **Incident T2D and CAD:** incident cases were defined using health episode statistics (HES) and self-report non-cancer illness questionnaire. HES was used to define incident cases as those with a first entry of CAD or T2D using primary or secondary ICD10 codes occurring after their first UK Biobank assessment center visit. Any participant reporting CAD or T2D at a follow-up questionnaire visit who had not reported it at the original visit was also classified as an incident case. **Asthma:** asthma cases were defined using non-cancer illness questions. **Cigarettes Per Day, Current Smoker, Ever Smoker, Former Smoker & Maternal Smoking:** smoking status, duration and frequency were attained for all UK Biobank participants. Participants were classified as former, current or never smoker. Ever smoker includes both former and current smokers. For ever smokers cigarettes per day was defined from the UK Biobank question about number of cigarettes smoked per day. Participants were also asked whether their mother regularly smoked around the time of their birth. **Menarche:** Female participants were asked at what age their periods started. Where participants had answered the

question at multiple assessment center visits the most recent valid value was taken. Values <9 years and >17 years were then excluded.

### **Systolic blood pressure (SBP) phenotype preparation for Mendelian randomization analysis of maternal birth weight allele scores on offspring SBP**

SBP was measured at three time points in the UK Biobank. At each follow-up participants were either measured using an automated machine or manually. The protocol was for each participant to have their SBP measurement taken twice at each follow-up, however some participants have only one measurement recorded.

For each follow-up, the average of the two SBP measures was calculated if both were recorded, otherwise the one recorded measure was used. If the participant reported being on blood pressure medication at the time of their measurement, then 10mmHg was added to their SBP measurement. If participants had an SBP measurement from the automated machine at baseline, then this was used, otherwise their SBP from follow-up 1 or 2 or the manual measurements from baseline, follow-up 1 or follow-up 2 were used (in this order). Finally, measures greater or less than 4.56 standard deviations from the mean were set to missing. This resulted in 501,242 participants, out of 502,647, with cleaned SBP measurements for analysis.

### **Simulations to ensure Mendelian randomization causal estimates were unbiased in the presence of a negative correlation between the maternal and fetal genetic effects:**

There is a negative correlation between the maternal and fetal genetic effects, estimated from either the SEM or a conditional linear regression model, due to two reasons:

1. For a subset of loci that influence pancreatic beta cell function (e.g. certain fasting glucose or T2D-susceptibility loci), we expect the same allele to have opposite effects on birth weight when present in the mother vs. when present in the fetus due to the underlying biology. Pancreatic beta cells secrete insulin, and maternal insulin influences fetal growth differently from fetal insulin: variants in the mother that reduce pancreatic beta cell function and hence insulin production would be expected to raise maternal glucose levels. Maternal glucose crosses the placenta, but maternal insulin does not. Instead, fetal insulin is secreted in response to maternal glucose, and acts as a growth hormone in utero. A rise in maternal glucose levels causes the fetus to secrete insulin, which promotes growth. Thus, a variant that reduces insulin secretion in the mother would indirectly lead to higher growth of the fetus, while the same variant in the fetus would lead to reduced growth due to reduced availability of fetal insulin. The paradigm is illustrated in a study of heterozygous glucokinase mutations in pregnancy (Hattersley et al 1998, Nat Genet), where a fetus with a paternally-inherited mutation was 500g lighter than average, while a fetus with no mutation, born to an affected mother was 600g heavier on average. Since then, a number of common type 2 diabetes variants have been shown to reduce birth weight when in the fetus, independently of maternal genotype (Freathy et al Diabetes 2009), and in our current study, we show opposite directions of maternal and fetal genetic correlation estimates genome-wide for T2D and fasting glucose loci using WLM-adjusted effects (NB, please note that we do not show this for SBP effects).
2. It is a consequence of there being a negative sampling covariance between the regression weights ( $\beta_m$  and  $\beta_f$ ). A negative correlation like this always occurs when

you regress a variable on correlated predictors. Intuitively, given a fixed amount of variance explained, each predictor tries to explain as much variance as possible; when one explains more of the variance, the other explains less. The sampling variance-covariance matrix for an ordinary least squares regression is  $\sigma_e^2(X'X)^{-1}$  where  $\sigma_e^2$  is the residual variance and X is the matrix of predictor variables. The diagonal elements are the sampling variance of the regression coefficients, and the off diagonal terms are the sampling covariance's between them. Whenever the predictors are correlated (as they are in the case of the maternal and fetal genotype), these off diagonal terms are going to be greater than or less than zero.

Although this negative correlation was expected, we wanted ensure that it did not have an impact on our Mendelian randomization analyses. Therefore, we conducted a series of simulations to estimate any potential bias on the causal estimates due to the negative correlation between the maternal and fetal genetic effects used as the SNP-exposure estimates.

### *Simulations*

For each replicate we generated grandparental (on the maternal side) and paternal genotypes at 100 SNPs. Assuming autosomal Mendelian inheritance, additivity and unit variance, the individual's own genotype and offspring's genotype were generated. The grand-maternal ( $Exposure_{G_i}$ ), maternal ( $Exposure_{M_i}$ ) and offspring's ( $Exposure_{O_i}$ ) exposure variable for each family  $i$ , was generated using the following equations:

$$Exposure_{G_i} = \sum_{j=1}^{100} (\beta_{SNP_j} \times SNP_{G_i,j}) + \beta_U \times U_i + \varepsilon_{G_i}$$

$$Exposure_{M_i} = \sum_{j=1}^{100} (\beta_{SNP_j} \times SNP_{M_i,j}) + \beta_U \times U_i + \varepsilon_{M_i}$$

$$Exposure_{O_i} = \sum_{j=1}^{100} (\beta_{SNP_j} \times SNP_{O_i,j}) + \beta_U \times U_i + \varepsilon_{O_i}$$

where  $\beta_{SNP_j}$  denotes the effect size of SNP<sub>j</sub> on the exposure,  $SNP_{X_i,j}$  is the genotype of individual X (either the grandmother [G], mother [M] or offspring [O]) in family *i* at SNP *j*, *U* is a standard normal random variable representing all residual genetic and environmental sources of similarity between mother and offspring,  $\beta_U$  is the total effect of *U* on the exposure of the individual in family *i*, and  $\varepsilon_{X_i}$  is a random normal variable with mean zero and variance needed to ensure that the exposure has unit variance asymptotically. For each SNP, the effect size and minor allele frequencies were drawn from two uniform distributions.

Birth weight of the mother ( $BW_M$ ) for each family *i*, was generated using the following equation:

$$BW_{M_i} = \beta_M \times Exposure_{G_i} + \beta_F \times Exposure_{M_i} + \beta_U \times U_{BW_i} + \varepsilon_{BW_{M_i}}$$

where  $\beta_M$  is the causal effect of maternal exposure on offspring birth weight,  $\beta_F$  is the causal effect of an individual's own exposure on their own birth weight,  $\beta_U$  is the total effect of  $U_{BW_i}$  on birth weight, and  $\varepsilon_{BW_{M_i}}$  is a random normal variable with mean zero and variance needed to ensure that  $BW_M$  has unit variance asymptotically. Similarly, offspring birth weight for each family *i*, was generated using the following equation:

$$BW_{O_i} = \beta_M \times Exposure_{M_i} + \beta_F \times Exposure_{O_i} + \beta_U \times U_{BW_i} + \varepsilon_{BW_{O_i}}$$

In all simulations, the regression of phenotype on residual shared genetic and environmental factors was set to 0.5 (i.e.,  $\beta_U = 0.5$ ). We considered the effects of: the strength of the causal effect of the maternal exposure on offspring birth weight ( $\beta_M = -0.15, 0, 0.15$ ); the strength of the causal effect of the individuals own exposure on their own birth weight ( $\beta_F = 0, 0.15$ ); and the strength of the genetic instruments on the exposure ( $\beta_{SNP_j}$ ; weak instruments had an effect size between 0.01 and 0.04 and a minor allele frequency between 0.1 and 0.5; medium instruments had an effect size between 0.02 and 0.04 and a minor allele frequency between 0.15 and 0.5; strong instruments had an

effect size of 0.05 and a minor allele frequency of 0.3). For each scenario, we generated 100 replicates of 40 000 families, the first 20 000 families were used to obtain the SNP-exposure estimates and the second 20 000 families were used to obtain the SNP-birth weight estimates.

### *Results of the simulations*

On average across the 100 replicates, the 100 SNPs that were weak instruments explained approximately 7% of the variance in the exposure, the 100 SNPs that were medium instruments explained approximately 10% of the variance and the 100 SNPs that were strong instruments explained approximately 25% of the variance. The correlation between the maternal and fetal genetic effects on birth weight was approximately -0.7 across all scenarios.

**Supplementary Figure 19** illustrates the results of the simulations, with the estimated causal effect of the maternal exposure on offspring birth weight ( $\beta_M$ ) displayed in the top panel and the estimated causal effect of the individuals own exposure on their own birth weight ( $\beta_F$ ) displayed in the bottom panel. The left panel show the results from simulations where there is only a causal effect of the maternal exposure on offspring birth weight ( $\beta_M=0.15$ ,  $\beta_F=0$ ); the middle panel displays simulations where there is a causal effect of the individual's own exposure on their own birth weight ( $\beta_M=0$ ,  $\beta_F=0.15$ ); and the right panel is where there is a causal effect of both the maternal and the individual's own exposure on birth weight and the effects are in opposite directions ( $\beta_M=-0.15$ ,  $\beta_F=0.15$ ). As can be seen in **Supplementary Figure 19**, there is a very small degree of weak instruments bias in the estimation of both the maternal and fetal causal effects when the instruments have a weak



or moderate effect on the exposure (with the median causal effect estimated from the simulations slightly biased towards zero). However, when we used strong instruments there was no appreciable bias for maternal or fetal causal effects, indicating that there is no bias introduced by the negative correlation between the maternal and fetal genetic effects on birth weight.

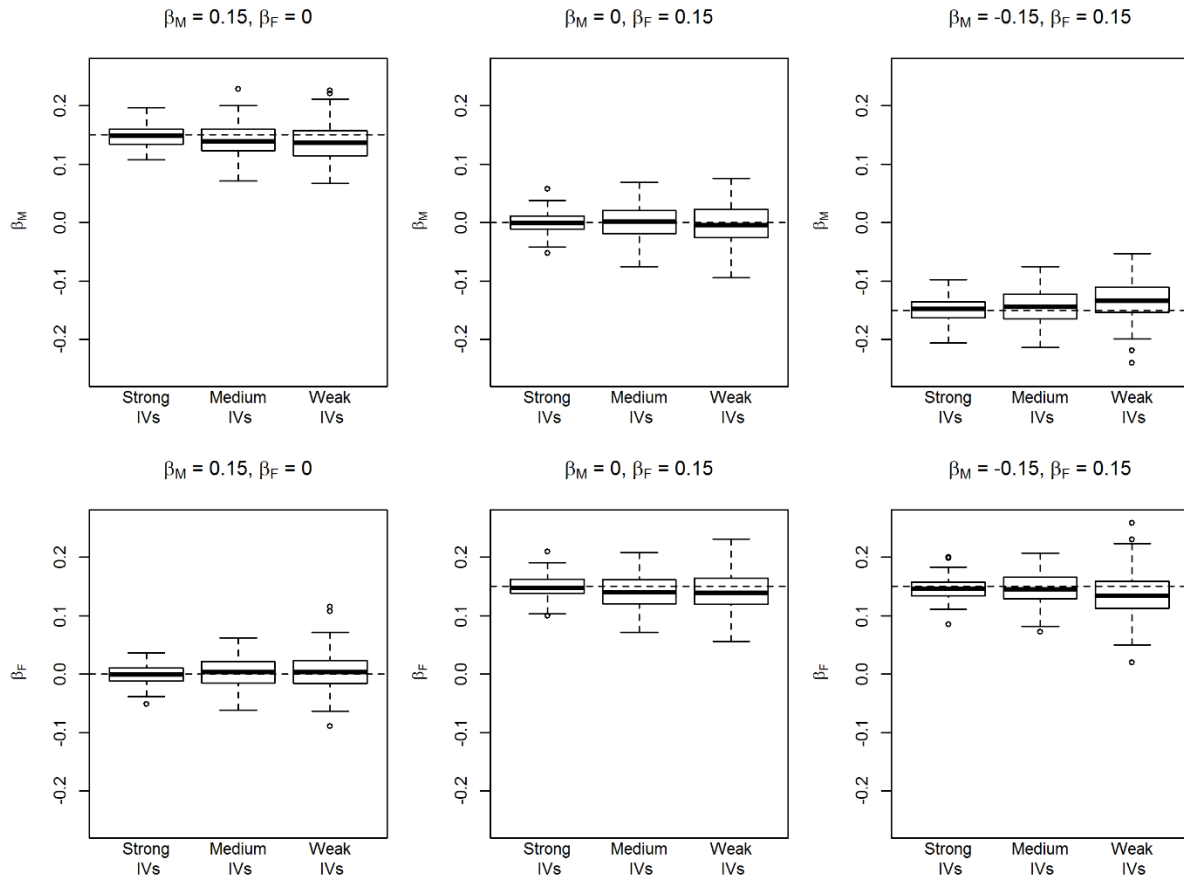

**Supplementary Figure 19**

**Boxplots of the bias in the maternal (top panel) or fetal (bottom panel) causal effect estimates from simulations with a negative correlation between the maternal and fetal genetic effects on the outcome.**

There were 100 replicates of the simulation with 100 SNPs in each replicate and 20,000 families for the SNP-exposure estimate and an additional 20,000 families for the SNP-birth weight estimate. Each boxplot includes the median (midline), the first and third quartiles (box), 1.5 times the interquartile range (whiskers) and any outliers (points outside the whiskers).

## **Supplementary Note 2: Study limitations**

There are some limitations to this study. Although we were able to fit the full SEM at the 209 lead SNPs, we were unable to fit the SEM at all SNPs across the genome. We have shown previously how a two degree of freedom test based on this SEM (i.e. where maternal and fetal paths are constrained to zero) can have greater power to detect associated loci than the one degree of freedom test used in the GWAS meta-analyses, particularly when maternal and fetal genetic effects on the phenotype are similar in magnitude (including situations where the effects operate in opposite directions). However, we are currently unable to fit the SEM nor conduct an equivalent test in a computationally feasible manner across the genome. If such a test were developed, it would provide greater power than the current one degree of freedom tests used in the WLM-adjusted analyses, particularly for SNPs where maternal and fetal genetic effects operate in opposite directions, and could therefore be used for locus detection in future analyses. In addition, we have not considered paternal genotype and it is possible that this omission has biased the results of some of our analyses. Furthermore, there are a number of limitations relating to the MR analyses. First, the MR results concern BW variation within the normal range and do not necessarily reflect the effects of extreme environmental events (e.g. famine), which may exert qualitatively different effects and produce long-term developmental compensations in addition to low BW. Additionally, we have assumed a linear relationship between BW and later life traits, which is an oversimplification, particularly for T2D: higher BW is associated with later T2D risk, in addition to lower BW, particularly in populations with a high prevalence of T2D. MR is not well placed to examine the effects of extreme events, or non-linear relationships, and alternative methodology will be necessary to investigate life-course associations in this context. Second, BW is the end marker of a developmental process, with

critical periods during the process that may make the fetus particularly sensitive to environmental influences. The MR analyses could therefore be masking effects at certain critical periods. We would need to look at maternal exposures on intrauterine growth trajectories or the specific function of the genetic variants on BW to interrogate this further. Third, we have assumed that genetic variants identified in large GWAS of SBP and glycemic traits in males and non-pregnant females are similarly associated in pregnant women. This assumption is reasonable, given that genetic associations are generally similar in pregnant vs non-pregnant women, though there is some indication that genetic effects on SBP are weaker in pregnancy (see Table 2, eTable 5 and eTable 6f in Tyrrell et al. <sup>17</sup>). Fourth, we have not investigated the potential gender difference in the associations between BW and later life traits. There is evidence that the association between BW and both T2D<sup>18</sup> and SBP<sup>19</sup> is stronger in females than males. However, to perform the MR analyses, we would require male and female-specific effect sizes for each of the exposures, which are currently not available. Finally, we have assumed that the critical period of exposure to maternal indirect genetic effects is pregnancy, and that the estimates do not reflect pre-pregnancy effects on primordial oocytes or post-natal effects<sup>20</sup>. However, since we have used BW-associated SNPs, the maternal effects are most-likely mediated *in utero*. While we cannot rule out postnatal effects<sup>21</sup>, our analysis of offspring SBP associations with BW-associated SNPs in father-child pairs showed different associations compared with mother-child pairs, implying postnatal effects were unlikely.

## References

- 1 Horikoshi, M. *et al.* Genome-wide associations for birth weight and correlations with adult disease. *Nature* **538**, 248-252, doi:10.1038/nature19806 (2016).
- 2 Beaumont, R. N. *et al.* Genome-wide association study of offspring birth weight in 86 577 women identifies five novel loci and highlights maternal genetic effects that are independent of fetal genetics. *Hum Mol Genet* **27**, 742-756, doi:10.1093/hmg/ddx429 (2018).
- 3 Finucane, H. K. *et al.* Heritability enrichment of specifically expressed genes identifies disease-relevant tissues and cell types. *Nat Genet* **50**, 621-629, doi:10.1038/s41588-018-0081-4 (2018).
- 4 Zanetti, D. *et al.* Birthweight, Type 2 Diabetes and Cardiovascular Disease: Addressing the Barker Hypothesis with Mendelian randomization. *bioRxiv*, doi:10.1101/208629 (2017).
- 5 Wang, T. *et al.* Low birthweight and risk of type 2 diabetes: a Mendelian randomisation study. *Diabetologia* **59**, 1920-1927, doi:10.1007/s00125-016-4019-z (2016).
- 6 Freathy, R. M. Can genetic evidence help us to understand the fetal origins of type 2 diabetes? *Diabetologia* **59**, 1850-1854, doi:10.1007/s00125-016-4057-6 (2016).
- 7 Auton, A. *et al.* A global reference for human genetic variation. *Nature* **526**, 68-74, doi:10.1038/nature15393 (2015).
- 8 Magi, R. & Morris, A. P. GWAMA: software for genome-wide association meta-analysis. *BMC bioinformatics* **11**, 288, doi:10.1186/1471-2105-11-288 (2010).
- 9 Bycroft, C. *et al.* The UK Biobank resource with deep phenotyping and genomic data. *Nature* **562**, 203-209, doi:10.1038/s41586-018-0579-z (2018).
- 10 Loh, P. R. *et al.* Efficient Bayesian mixed-model analysis increases association power in large cohorts. *Nat Genet* **47**, 284-290, doi:10.1038/ng.3190 (2015).
- 11 Ioannidis, J. P., Patsopoulos, N. A. & Evangelou, E. Heterogeneity in meta-analyses of genome-wide association investigations. *PLoS one* **2**, e841, doi:10.1371/journal.pone.0000841 (2007).
- 12 Bulik-Sullivan, B. *et al.* An atlas of genetic correlations across human diseases and traits. *Nat Genet* **47**, 1236-1241, doi:10.1038/ng.3406 (2015).
- 13 Warrington, N. M., Freathy, R. M., Neale, M. C. & Evans, D. M. Using structural equation modelling to jointly estimate maternal and fetal effects on birthweight in the UK Biobank. *International journal of epidemiology*, doi:10.1093/ije/dyy015 (2018).
- 14 Neale, M. & Cardon, L. *Methodology for Genetic Studies of Twins and Families*. (Springer Netherlands, 1992).
- 15 Mardia, K. V. *Multivariate analysis / K.V. Mardia, J.T. Kent, J.M. Bibby*. (Academic Press, 1979).
- 16 Willer, C. J., Li, Y. & Abecasis, G. R. METAL: fast and efficient meta-analysis of genomewide association scans. *Bioinformatics (Oxford, England)* **26**, 2190-2191, doi:10.1093/bioinformatics/btq340 (2010).
- 17 Tyrrell, J. *et al.* Genetic Evidence for Causal Relationships Between Maternal Obesity-Related Traits and Birth Weight. *JAMA : the journal of the American Medical Association* **315**, 1129-1140, doi:10.1001/jama.2016.1975 (2016).

- 18 Zimmermann, E., Gamborg, M., Sorensen, T. I. & Baker, J. L. Sex Differences in the Association Between Birth Weight and Adult Type 2 Diabetes. *Diabetes* **64**, 4220-4225, doi:10.2337/db15-0494 (2015).
- 19 Gamborg, M. *et al.* Birth weight and systolic blood pressure in adolescence and adulthood: meta-regression analysis of sex- and age-specific results from 20 Nordic studies. *American journal of epidemiology* **166**, 634-645, doi:10.1093/aje/kwm042 (2007).
- 20 Lawlor, D. *et al.* Using Mendelian randomization to determine causal effects of maternal pregnancy (intrauterine) exposures on offspring outcomes: Sources of bias and methods for assessing them. *Wellcome open research* **2**, 11, doi:10.12688/wellcomeopenres.10567.1 (2017).
- 21 Kong, A. *et al.* The nature of nurture: Effects of parental genotypes. *Science (New York, N.Y.)* **359**, 424-428, doi:10.1126/science.aan6877 (2018).

### **Supplementary Note 3: EGG Membership**

Full list of members (as of June 2018), listed in alphabetical order.

Linda S Adair<sup>1</sup>, Emma Ahlqvist<sup>2</sup>, Tarunveer S Ahluwalia<sup>3,4,5</sup>, Peter Almgren<sup>2</sup>, Wei Ang<sup>6</sup>, Mustafa Atalay<sup>7</sup>, Robin N Beaumont<sup>8</sup>, Jacques S Beckmann<sup>9</sup>, Hans Bisgaard<sup>3</sup>, Tom Bond<sup>10</sup>, Klaus Bønnelykke<sup>3</sup>, Dorret I Boomsma<sup>11,12,13,14</sup>, Judith B Borja<sup>15,16</sup>, Jonathan P Bradfield<sup>17,18</sup>, Mariona Bustamante<sup>19,20,21</sup>, Alana Cavadino<sup>22,23</sup>, Pimphen Charoen<sup>10,24</sup>, Lachlan Coin<sup>25</sup>, Cyrus Cooper<sup>26</sup>, Diana L Cousminer<sup>27,28</sup>, John A Curtin<sup>29</sup>, Adnan Custovic<sup>30</sup>, Shikta Das<sup>31</sup>, Felix R Day<sup>32</sup>, N Maneka De Silva<sup>10</sup>, George V Dedoussis<sup>33</sup>, Paul Elliott<sup>10</sup>, Johan G Eriksson<sup>34,35,36</sup>, David M Evans<sup>37,38,39</sup>, João Fadista<sup>40</sup>, Bjarke Feenstra<sup>40</sup>, Janine F Felix<sup>41,42,43</sup>, Timothy M Frayling<sup>8</sup>, Rachel M Freathy<sup>8,37</sup>, Romy Gaillard<sup>42</sup>, Frank Geller<sup>40</sup>, Vincente Gilsanz<sup>44</sup>, Struan FA Grant<sup>17,27,28,45</sup>, Niels Grarup<sup>4</sup>, Leif Groop<sup>2,46</sup>, Monica Guxens<sup>19,20,21</sup>, Dexter Hadley<sup>47</sup>, Hakon Hakonarson<sup>17,27,45</sup>, Torben Hansen<sup>4</sup>, Andrew T Hattersley<sup>8,48</sup>, M Geoffrey Hayes<sup>49</sup>, Johannes Hebebrand<sup>50</sup>, Joachim Heinrich<sup>51,52</sup>, Øyvind Helgeland<sup>53,54,55</sup>, Tine B Henriksen<sup>56</sup>, Anke Hinney<sup>50</sup>, Joel N Hirschhorn<sup>57,58,59</sup>, Marie-France Hivert<sup>60,61,62</sup>, Berthold Hochoer<sup>63,64</sup>, John W Holloway<sup>65</sup>, Momoko Horikoshi<sup>66,67,68</sup>, Jouke-Jan Hottenga<sup>11,12,14</sup>, Elina Hyppönen<sup>23,69,70</sup>, Bo Jacobsson<sup>55,71</sup>, Vincent WV Jaddoe<sup>41,42,43</sup>, Marjo-Riitta Järvelin<sup>10,72,73,74,75</sup>, Stefan Johansson<sup>53,76</sup>, Heidi J Kalkwarf<sup>77</sup>, Marjan Kerkhof<sup>78</sup>, Antje Körner<sup>79,80</sup>, Sailesh Kotecha<sup>81</sup>, Eskil Kreiner-Møller<sup>3,82</sup>, Benard Kulohoma<sup>66</sup>, Zoltán Kutalik<sup>83,84</sup>, Timo A Lakka<sup>7,85,86</sup>, Joan M Lappe<sup>87</sup>, Debbie A Lawlor<sup>37,38,88</sup>, Terho Lehtimäki<sup>89,90</sup>, Alexandra M Lewin<sup>10</sup>, Cecilia M Lindgren<sup>66,91,92</sup>, Virpi Lindi<sup>7</sup>, Allan Linneberg<sup>93,94</sup>, Xueping Liu<sup>40</sup>, Jun Liu<sup>42</sup>, William L Lowe Jr<sup>49</sup>, Ronald CW Ma<sup>95,96,97</sup>, Aurélien Macé<sup>83</sup>, Reedik Mägi<sup>98</sup>, Per Magnus<sup>99</sup>, Anubha Mahajan<sup>66,67</sup>, Nina S McCarthy<sup>100</sup>, Mark I McCarthy<sup>66,67,101</sup>, Mads Melbye<sup>40,102</sup>, Karen L Mohlke<sup>103</sup>, Claire Monnereau<sup>41,42,43</sup>, Dennis O Mook-Kanamori<sup>104,105</sup>, Camilla S Morgen<sup>106</sup>, Andrew P Morris<sup>66,98,107</sup>, Jeffrey C Murray<sup>108</sup>, Ronny Myhre<sup>109</sup>, Pål R Njølstad<sup>53,54</sup>, Ellen A Nohr<sup>110</sup>, Ioanna Ntalla<sup>111</sup>, Paul O'Reilly<sup>112</sup>, Sharon E Oberfield<sup>113</sup>, Emily Oken<sup>114</sup>, Ken K Ong<sup>32,115</sup>, Kalliope Panoutsopoulou<sup>116</sup>, Oluf Pedersen<sup>4</sup>, Craig E Pennell<sup>117</sup>, John RB Perry<sup>32</sup>, Niina Pitkänen<sup>118</sup>, Beate St Pourcain<sup>37,119</sup>, Christine Power<sup>23</sup>, Rashmi B Prasad<sup>2</sup>, Inga Prokopenko<sup>66,120</sup>, Olli T Raitakari<sup>118,121</sup>, Rebecca M Reynolds<sup>122</sup>, Rebecca C Richmond<sup>37,38</sup>, Alina Rodriguez<sup>10,123</sup>, Rany Salem<sup>58,124,125,126</sup>, Seang-Mei Saw<sup>127,128</sup>, Theresia M Schnurr<sup>4</sup>, Sylvain Sebert<sup>10,72,74,129</sup>, John A Shepherd<sup>130</sup>, Angela Simpson<sup>29</sup>, Line Skotte<sup>40</sup>, Thorkild IA Sørensen<sup>4,37,106</sup>, Marie Standl<sup>51</sup>, Eric AP Steegers<sup>131</sup>, David P Strachan<sup>132</sup>, Jordi Sunyer<sup>19,20,21,133</sup>, Michelle Taylor<sup>37,38</sup>, Yik-Ying Teo<sup>127,134,135</sup>, Elisabeth Thiering<sup>51,136</sup>, Nicholas J Timpson<sup>37,38</sup>, Jessica Tyrrell<sup>8,137</sup>, André G Uitterlinden<sup>41,42,138</sup>, Cornelia M van Duijn<sup>42</sup>, Suzanne Voegeleang<sup>41,42,43</sup>, Tanja GM Vrijkotte<sup>139</sup>, Carol A Wang<sup>117</sup>, Nicole M Warrington<sup>39</sup>, William J Watkins<sup>81</sup>, H-Erich Wichmann<sup>51,140,141</sup>, Elisabeth E Widén<sup>46</sup>, Gonneke Willemsen<sup>11,12,14</sup>, James F Wilson<sup>142,143</sup>, Hanieh Yaghootkar<sup>8</sup>, Mohammad Hadi Zafarmand<sup>139,144</sup>, Eleftheria Zeggini<sup>116,145</sup>, Babette S Zemel<sup>45,146</sup>

1. Department of Nutrition, University of North Carolina, Chapel Hill, NC 27599, USA.
2. Department of Clinical Sciences, Diabetes and Endocrinology, Lund University Diabetes Centre, Malmö, SE-205 02, Sweden.
3. COPSAC, Copenhagen Prospective Studies on Asthma in Childhood, Herlev and Gentofte Hospital, University of Copenhagen, Copenhagen, 2900 Hellerup, Denmark.
4. Novo Nordisk Foundation Center for Basic Metabolic Research, Faculty of Health and Medical Sciences, University of Copenhagen, Copenhagen, DK-2200, Denmark.
5. Steno Diabetes Center Copenhagen, Gentofte, 2820, Denmark.

6. Division of Obstetrics and Gynaecology, The University of Western Australia, Crawley, WA, 6009, Australia.
7. Institute of Biomedicine, Physiology, University of Eastern Finland, Kuopio, 70211, Finland.
8. Institute of Biomedical and Clinical Science, College of Medicine and Health, University of Exeter, Royal Devon and Exeter Hospital, Exeter, EX2 5DW, UK.
9. University of Lausanne, Lausanne, CH-1015, Switzerland.
10. Department of Epidemiology and Biostatistics, MRC-PHE Centre for Environment & Health, School of Public Health, Imperial College London, London, W2 1PG, UK.
11. Department of Biological Psychology, Vrije Universiteit Amsterdam, Amsterdam, 1081 BT, The Netherlands.
12. Amsterdam Public Health, Amsterdam, The Netherlands.
13. Amsterdam Reproduction and Development, Amsterdam, The Netherlands.
14. Netherlands Twin Register, Department of Biological Psychology, VU University, Amsterdam, 1081 HV, The Netherlands.
15. USC-Office of Population Studies Foundation, Inc., University of San Carlos, Cebu City, 6000, Philippines.
16. Department of Nutrition and Dietetics, University of San Carlos, Cebu City, 6000, Philippines.
17. Center for Applied Genomics, The Children's Hospital of Philadelphia, Philadelphia, PA 19104, USA.
18. Quantinuum Research LLC, San Diego, CA, 92101, USA.
19. ISGlobal, Institute for Global Health, Barcelona, 08003, Spain.
20. Universitat Pompeu Fabra (UPF), Barcelona, 08003, Spain.
21. CIBER de Epidemiología y Salud Pública (CIBERESP), Madrid, 28029, Spain.
22. Section of Epidemiology & Biostatistics, School of Population Health, University of Auckland, Auckland, New Zealand.
23. Population, Policy and Practice, UCL Great Ormond Street Institute of Child Health, University College London, London, WC1N 1EH, UK.
24. Department of Tropical Hygiene, Faculty of Tropical Medicine, Mahidol University, Bangkok, 10400, Thailand.
25. Institute for Molecular Bioscience, University of Queensland, QLD, Australia.
26. Medical Research Council Lifecourse Epidemiology Unit, University of Southampton, Southampton, SO17 1BJ, UK.
27. Division of Human Genetics, The Children's Hospital of Philadelphia, Philadelphia, PA 19104, USA.
28. Department of Genetics, Perelman School of Medicine, University of Pennsylvania, Philadelphia, 19104, USA.
29. Division of Infection Immunity and Respiratory Medicine, School of Biological Sciences, The University of Manchester, Manchester Academic Health Science Centre, and Manchester University NHS Foundation Trust, Manchester, M13 9NT, UK.
30. Department of Paediatrics, Imperial College London, London, SW7 2AZ, UK.
31. Medical Research Council Unit for Lifelong Health and Ageing at UCL, Institute of Cardiovascular sciences, UCL, London, WC1B 5JU, UK.
32. MRC Epidemiology Unit, University of Cambridge School of Clinical Medicine, Cambridge, CB2 0QQ, UK.



33. Department of Nutrition and Dietetics, School of Health Science and Education, Harokopio University, Athens, 17671, Greece.
34. National Institute for Health and Welfare, Helsinki, 00271, Finland.
35. Department of General Practice and Primary Health Care, University of Helsinki and Helsinki University Hospital, Helsinki, 00014, Finland.
36. Folkhälsan Research Center, Helsinki, 00250, Finland.
37. Medical Research Council Integrative Epidemiology Unit at the University of Bristol, Bristol, BS8 2BN, UK.
38. Population Health Sciences, Bristol Medical School, University of Bristol, Bristol, BS8 2BN, UK.
39. University of Queensland Diamantina Institute, Translational Research Institute, Brisbane, QLD, 4072, Australia.
40. Department of Epidemiology Research, Statens Serum Institute, Copenhagen, DK-2300, Denmark.
41. The Generation R Study Group, Erasmus MC, University Medical Center Rotterdam, Rotterdam, 3015 CE, The Netherlands.
42. Department of Epidemiology, Erasmus MC, University Medical Center Rotterdam, Rotterdam, 3015 CE, The Netherlands.
43. Department of Pediatrics, Erasmus MC, University Medical Center Rotterdam, Rotterdam, 3015 CE, The Netherlands.
44. Department of Radiology, Children's Hospital Los Angeles, Los Angeles, CA 90027, USA.
45. Department of Pediatrics, Perelman School of Medicine, University of Pennsylvania, Philadelphia, PA 19104, USA.
46. Institute for Molecular Medicine Finland FIMM, University of Helsinki, Helsinki, Finland.
47. Department of Pediatrics, University of California San Francisco School of Medicine, San Francisco, CA 94143, USA.
48. NIHR Exeter Clinical Research Facility, University of Exeter College of Medicine and Health and Royal Devon and Exeter NHS Foundation Trust, Exeter, EX2 5DW, UK.
49. Department of Medicine, Division of Endocrinology, Metabolism, and Molecular Medicine, Feinberg School of Medicine, Northwestern University, Chicago, IL 60611, USA.
50. Department of Child and Adolescent Psychiatry, Psychosomatics and Psychotherapy, University Hospital Essen, University of Duisburg-Essen, Essen, 45141, Germany.
51. Institute of Epidemiology, Helmholtz Zentrum München - German Research Center for Environmental Health, Neuherberg, Germany.
52. Institute and Outpatient Clinic for Occupational, Social and Environmental Medicine, University Hospital of Ludwig Maximilians University, Munich, Germany.
53. KG Jebsen Center for Diabetes Research, Department of Clinical Science, University of Bergen, Bergen, N-5020, Norway.
54. Department of Pediatrics, Haukeland University Hospital, Bergen, 5021, Norway.
55. Department of Genetics and Bioinformatics, Domain of Health Data and Digitalisation, Norwegian Institute of Public Health, Oslo, N-0473, Norway.
56. Department of Paediatrics and Adolescent Medicine, Aarhus University Hospital, Aarhus N, DK-8200, Denmark.

57. Programs in Metabolism and Medical & Population Genetics, Broad Institute of Harvard and MIT, Cambridge, MA 02142, USA.
58. Department of Genetics, Harvard Medical School, Boston, MA 02115, USA.
59. Division of Endocrinology and Center for Basic and Translational Obesity Research, Boston Children's Hospital, Boston, MA, 02115, USA.
60. Department of Population Medicine, Harvard Pilgrim Health Care Institute, Harvard Medical School, Boston, MA 02215, USA.
61. Diabetes Center, Massachusetts General Hospital, Boston, MA 02114, USA.
62. Department of Medicine, Universite de Sherbrooke, Sherbooke, QC J1K 2R1, Canada.
63. Institute of Nutritional Science, University of Potsdam, Nuthetal, 14558, Germany.
64. The First Affiliated Hospital of Jinan University, Guangzhou, 510630, China.
65. Human Development & Health, Faculty of Medicine, University of Southampton, Southampton, SO16 6YD, UK.
66. Wellcome Centre for Human Genetics, University of Oxford, Oxford, OX3 7BN, UK.
67. Oxford Centre for Diabetes, Endocrinology and Metabolism, University of Oxford, Oxford, OX3 7LE, UK.
68. RIKEN, Centre for Integrative Medical Sciences, Laboratory for Endocrinology, Metabolism and Kidney diseases, Yokohama, Kanagawa, 230-0045, Japan.
69. Australian Centre for Precision Health, University of South Australia Cancer Research Institute, Adelaide, SA, 5001, Australia.
70. South Australian Health and Medical Research Institute, Adelaide, SA, 5001, Australia.
71. Department of Obstetrics and Gynecology, Sahlgrenska Academy, University of Gothenburg, Diagnosvägen 15, SE-416 85 Gothenburg, Sweden.
72. Biocenter Oulu, University of Oulu, Oulu, 90220, Finland.
73. Unit of Primary Care, Oulu University Hospital, Oulu, 90220, Finland.
74. Center for Life Course Health Research, Faculty of Medicine, University of Oulu, Oulu, FI-90014, Finland.
75. Department of Life Sciences, College of Health and Life Sciences, Brunel University London, Middlesex, UB8 3PH, UK.
76. Department of Medical Genetics, Haukeland University Hospital, Bergen, Norway.
77. Division of Gastroenterology, Hepatology and Nutrition, Cincinnati Children's Hospital Medical Center, Cincinnati, OH 45229, USA.
78. Observational & Pragmatic Research Institute Pte Ltd, Singapore, Singapore.
79. Pediatric Research Center, Department of Women's & Child Health, University of Leipzig, Leipzig, 04109, Germany.
80. IFB Adiposity Diseases, University of Leipzig, Leipzig, 04109, Germany.
81. Department of Child Health, School of Medicine, Cardiff University, Cardiff, CF10 3AT, UK.
82. Danish Pediatric Asthma Center, Copenhagen University Hospital, Gentofte, DK-2100, Denmark.
83. Institute of Social and Preventive Medicine, Lausanne University Hospital (CHUV), Lausanne, 1011, Switzerland.
84. Swiss Institute of Bioinformatics, Lausanne, 1015, Switzerland.
85. Department of Clinical Physiology and Nuclear Medicine, Kuopio University Hospital, Kuopio, 70210, Finland.
86. Kuopio Research Institute of Exercise Medicine, Kuopio, 70100, Finland.

87. Division of Endocrinology, Department of Medicine, Creighton University, Omaha, NE 68178, USA.
88. Bristol NIHR Biomedical Research Centre, Bristol, UK.
89. Department of Clinical Chemistry, Fimlab Laboratories, Tampere University Hospital, Tampere, Finland.
90. Department of Clinical Chemistry, Finnish Cardiovascular Research Center - Tampere, Faculty of Medicine and Health Technology, Tampere University, Tampere, 33520, Finland.
91. Li Ka Shing Centre for Health Information and Discovery, The Big Data Institute, University of Oxford, Oxford, OX3 7LF, UK.
92. The Broad Institute of Harvard and MIT, Cambridge, USA.
93. Center for Clinical Research and Prevention, Bispebjerg and Frederiksberg Hospital, The Capital Region, Frederiksberg, 2000, Denmark.
94. Department of Clinical Medicine, Faculty of Health and Medical Sciences, University of Copenhagen, Copenhagen, Denmark.
95. Department of Medicine and Therapeutics, The Chinese University of Hong Kong, Hong Kong, China.
96. Li Ka Shing Institute of Health Sciences, The Chinese University of Hong Kong, Hong Kong, China.
97. Hong Kong Institute of Diabetes and Obesity, The Chinese University of Hong Kong, Hong Kong, China.
98. Estonian Genome Center, University of Tartu, Tartu, 50090, Estonia.
99. Centre for Fertility and Health, Norwegian Institute of Public Health, Oslo, N-0403, Norway.
100. Centre for Genetic Origins of Health and Disease (GOHaD), The University of Western Australia, Crawley, WA, 6000, Australia.
101. Oxford NIHR Biomedical Research Centre, Oxford University Hospitals NHS Foundation Trust, John Radcliffe Hospital, Oxford, OX3 9DU, UK.
102. Department of Medicine, Stanford School of Medicine, Stanford, CA 94305, USA.
103. Department of Genetics, University of North Carolina, Chapel Hill, NC 27599, USA.
104. Department of Clinical Epidemiology, Leiden University Medical Center, Leiden, 2333 ZA, The Netherlands.
105. Department of Public Health and Primary Care, Leiden University Medical Center, Leiden, 2333 ZA, The Netherlands.
106. Department of Public Health, Section of Epidemiology, Faculty of Health and Medical Sciences, University of Copenhagen, Copenhagen, Copenhagen, DK-1014, Denmark.
107. Department of Biostatistics, University of Liverpool, Liverpool, L69 3GL, UK.
108. Department of Pediatrics, University of Iowa, Iowa City, IA 52242, USA.
109. Department of Genetics and Bioinformatics, Norwegian Institute of Public Health, Oslo, N-0403, Norway.
110. Research Unit for Gynaecology and Obstetrics, Institute of Clinical Research, University of Southern Denmark, Odense, DK-5000, Denmark.
111. William Harvey Research Institute, Barts and the London School of Medicine and Dentistry, Queen Mary University of London, London, EC1M 6BQ, UK.
112. Medical Research Council (MRC), Social, Genetic and Developmental Psychiatry Centre, Institute of Psychiatry, Psychology & Neuroscience, King's College London, London, SE5 8AF, UK.

113. Division of Pediatric Endocrinology, Diabetes, and Metabolism, Department of Pediatrics, Columbia University Medical Center, New York, NY 10032, USA.
114. Obesity Prevention Program, Department of Population Medicine, Harvard Medical School and Harvard Pilgrim Health Care Institute, Boston, MA 02215, USA.
115. Department of Paediatrics, University of Cambridge, Cambridge, CB2 0QQ, UK.
116. Wellcome Sanger Institute, Hinxton, Cambridgeshire, CB10 1HH, UK.
117. School of Medicine and Public Health, Faculty of Medicine and Health, The University of Newcastle, Callaghan, NSW, 2308, Australia.
118. Research Centre of Applied and Preventive Cardiovascular Medicine, University of Turku, Turku, 20014, Finland.
119. Max Planck Institute for Psycholinguistics, Nijmegen, 6525 XD, The Netherlands.
120. Section of Genomics of Common Disease, Department of Medicine, Imperial College London, London, SW7 2AZ, UK.
121. Department of Clinical Physiology and Nuclear Medicine, Turku University Hospital, Turku, 20520, Finland.
122. BHF Centre for Cardiovascular Science, University of Edinburgh, Queen's Medical Research Institute, Edinburgh, EH16 4TJ, UK.
123. Department of Psychology, Mid Sweden University, Östersund, SE-831 25, Sweden.
124. Department of Medicine, Division of Endocrinology, Boston Children's Hospital, Boston, MA 02115, USA.
125. Program in Medical and Population Genetics, Broad Institute of Harvard and MIT, Cambridge, MA 02142, USA.
126. Center for Basic and Translational Obesity Research, Boston Children's Hospital, Boston, MA 02115, USA.
127. Saw Swee Hock School of Public Health, National University of Singapore, National University Health System, Singapore, 119077, Singapore.
128. Singapore Eye Research Institute, Singapore, 168751, Singapore.
129. Department of Genomics of Complex Diseases, Imperial College, London, UK.
130. Department of Epidemiology, Cancer Center, University of Hawaii (Manoa), Honolulu, Hawaii, 96813, USA.
131. Department of Obstetrics and Gynecology, Erasmus MC, University Medical Center Rotterdam, Rotterdam, 3015 CE, The Netherlands.
132. Population Health Research Institute, St George's University of London, London, SW17 0RE, UK.
133. IMIM (Hospital del Mar Medical Research Institute), Barcelona, 08003, Spain.
134. Department of Statistics and Applied Probability, National University of Singapore, Singapore, 117546, Singapore.
135. Life Sciences Institute, National University of Singapore, Singapore, 117456, Singapore.
136. Division of Metabolic and Nutritional Medicine, Dr. von Hauner Children's Hospital, University of Munich Medical Center, Munich, 80337, Germany.
137. European Centre for Environment and Human Health, University of Exeter, Truro, TR1 3HD, UK.
138. Department of Internal Medicine, Erasmus MC, University Medical Center Rotterdam, Rotterdam, 3015 CE, The Netherlands.

139. Department of Public Health, Amsterdam Public Health Research Institute, Amsterdam UMC, location Academic Medical Center, University of Amsterdam, Amsterdam, 1105 AZ, The Netherlands.
140. Institute of Medical Statistics and Epidemiology, Technical University Munich, Munich, D-80333, Germany.
141. Institute of Medical Informatics, Biometry and Epidemiology, Ludwig Maximilians University, Munich, 81377, Germany.
142. Usher Institute for Population Health Sciences and Informatics, University of Edinburgh, Edinburgh, EH8 9AG, UK.
143. MRC Human Genetics Unit, Institute of Genetics and Molecular Medicine, University of Edinburgh, Edinburgh, EH4 2XU, UK.
144. Department of Clinical Epidemiology, Biostatistics and Bioinformatics, Amsterdam Public Health Research Institute, Amsterdam UMC, location Academic Medical Center, University of Amsterdam, Amsterdam, 1105 AZ, The Netherlands.
145. Institute of Translational Genomics, Helmholtz Zentrum München – German Research Center for Environmental Health, Neuherberg, Germany.
146. Division of Gastroenterology, Hepatology and Nutrition, The Children's Hospital of Philadelphia, Philadelphia, PA 19104, USA.

#### **Supplementary Note 4: Study Acknowledgements**

**1958BC:** This work made use of data and samples generated by the 1958 Birth Cohort (NCDS), which is managed by the Centre for Longitudinal Studies at the UCL Institute of Education. The authors are deeply grateful to the 1958 birth cohort participants for their longstanding commitment and support, and to all staff for cohort coordination and data collection.

**ABCD:** We thank all participating hospitals, obstetric clinics, general practitioners and primary schools for their assistance in implementing the ABCD study. We also gratefully acknowledge all the women and children who participated in this study for their cooperation. The ABCD study protocol was approved by the Central Committee on Research Involving Human Subjects in The Netherlands, the medical ethics review committees of the participating hospitals and the Registration Committee of the Municipality of Amsterdam. All ABCD participants gave written informed consent for data collection of the phenotypes. Regarding the DNA collection and analysis, an opt-out procedure was used (METC approval 2002\_039#B2013531).

**ALSPAC:** We are extremely grateful to all the families who took part in this study, the midwives for their help in recruiting them, and the whole ALSPAC team, which includes interviewers, computer and laboratory technicians, clerical workers, research scientists, volunteers, managers, receptionists and nurses. GWAS data were generated by Sample Logistics and Genotyping Facilities at the Wellcome Trust Sanger Institute and LabCorp (Laboratory Corporation of America) using support from 23andMe.

**Barcelona Supercomputing Center:** We acknowledge PRACE for awarding us access to MareNostrum supercomputer, based in Spain at Barcelona.

**CHOP:** The authors thank the network of primary care clinicians and the patients and families for their contribution to this project and to clinical research facilitated by the Pediatric Research Consortium (PeRC) at The Children's Hospital of Philadelphia. R. Chiavacci, E. Dabaghyan, A. (Hope) Thomas, K. Harden, A. Hill, C. Johnson-Honesty, C. Drummond, S. Harrison, F. Salley, C. Gibbons, K. Lilliston, C. Kim, E. Frackelton, G. Otieno, K. Thomas, C. Hou, K. Thomas and M.L. Garris provided expert assistance with genotyping and/or data collection and management. The authors would also like to thank S. Kristinsson, L.A. Hermannsson and A. Krisbjörnsson of Rafsörninn ehf for extensive software design and contributions.

**CLHNS:** We thank the USC-Office of Population Studies Foundation, Inc. research and data collection teams and the study participants who generously provided their time for this study.

**CoLaus:** The CoLaus study would like to thank all the people who participated in the recruitment of the participants, data collection and validation, particularly Nicole Bonvin, Yolande Barreau, Mathieu Firmann, François Bastardot, Julien Vaucher, Panagiotis Antiochos and Cédric Gubelmann.

**COPSAC2000, COPSAC2010 and COPSAC-REGISTRY:** We gratefully express our gratitude to the participants of the COPSAC2000, COPSAC2010 and COPSAC-REGISTRY cohort study for all their support and commitment. We also acknowledge and appreciate the unique efforts of the COPSAC research team.

**DNBC:** We are very grateful to all DNBC families who took part in the study. We would also like to thank everyone involved in data collection and biological material handling.

**EFSOCH (Exeter Family Study of Childhood Health):** We are grateful to the staff at the Royal Devon and Exeter NHS Foundation Trust Maternity Unit.

**EPIC-Norfolk:** We thank all EPIC-Norfolk study participants and staff for their contribution to the study.

**ERF:** We are grateful to all study participants and their relatives, general practitioners and neurologists for their contributions and to P. Veraart for her help in genealogy, J. Vergeer for the supervision of the laboratory work and P. Snijders for his help in data collection.

**Fenland:** We are grateful to all the volunteers for their time and help, and to the General Practitioners and practice staff for assistance with recruitment. We thank the Fenland Study Investigators, Fenland Study Co-ordination team and the Epidemiology Field, Data and Laboratory teams.

**FHS:** The authors thank the participants for their dedication to the study.

**Gen3G:** The investigators would like to acknowledge the participants, the research staff from the endocrinology group at the Centre de Recherche clinique of the Centre Hospitalier de l'Université de Sherbrooke (CR-CHUS), the clinical and research staff of the Clinique de Prélèvement en Grossesse du CHUS, and the clinical staff from the CHUS Obstetric Department. The CR-CHUS is a FRQ-Santé affiliated research centre; recruitment and follow-up of Gen3G participants was possible based on the on-going support from the CR-CHUS.

**Generation R:** The Generation R Study is conducted by Erasmus MC, University Medical Center Rotterdam, in close collaboration with the School of Law and Faculty of Social Sciences of the Erasmus University Rotterdam, the Municipal Health Service Rotterdam area, Rotterdam, the Rotterdam Homecare Foundation, Rotterdam and the Stichting Trombosedienst & Artsenlaboratorium Rijnmond (STAR-MDC), Rotterdam. We gratefully acknowledge the contribution of participating children and mothers, parents, general practitioners, hospitals, midwives and pharmacies in Rotterdam. The study protocol was approved by the Medical Ethical Committee of Erasmus MC, Rotterdam. Written informed consent was obtained for all participants. The generation and management of GWAS genotype data was executed by the Human Genotyping Facility of the Genetic Laboratory of the Department of Internal Medicine, Erasmus MC, Rotterdam, the Netherlands. We thank Pascal Arp, Mila Jhamai, Marijn Verkerk, Lizbeth Herrera and Marjolein Peters for their help in creating, managing and QC of the GWAS database, and Karol Estrada and Carolina Medina-Gomez for their support in creation and analysis of imputed data. We would like to thank Anis Abuseiris, Karol Estrada, Dr. Tobias A. Knoch, and Rob de Graaf as well as their institutions Biophysical Genomics, Erasmus MC Rotterdam, The Netherlands, for their help

in creating GRIMP, BigGRID, MediGRID, and Services@MediGRID/D-Grid, (funded by the German Bundesministerium fuer Forschung und Technology; grants 01 AK 803 A-H, 01 IG 07015 G) for access to their grid computing resources.

**GINIplus&LISA:** We thank all families for participation in the studies and the LISA and GINIplus study teams for their excellent work. The GINIplus study team wishes to acknowledge the following: Helmholtz Zentrum Muenchen - German Research Center for Environmental Health, Institute of Epidemiology, Munich (Heinrich J, Brueske I, Schulz H, Standl M, Thiering E, Tiesler CMT, Chen C-M, Schnappinger M); Department of Pediatrics, Marien-Hospital, Wesel (Berdel D, von Berg A); Department of Pediatrics, Ludwig Maximilians University, Munich (Koletzko S); Department of Pediatrics, Technical University, Munich (Bauer CP, Hoffmann U); IUF - Leibniz Research Institute for Environmental Medicine, Duesseldorf (Schikowski T, Kraemer U, Link E, Cramer C). The LISA study team wishes to acknowledge the following: Helmholtz Zentrum Muenchen - German Research Center for Environment and Health, Institute of Epidemiology, Neuherberg (Heinrich J, Brueske I, Schulz H, Standl M, Thiering E, Tiesler CMT, Chen C-M, Schnappinger M); Department of Pediatrics, Marien-Hospital, Wesel (von Berg A); Bad Honnef (Schaaf B); UFZ-Centre for Environmental Research Leipzig-Halle, Department of Environmental Immunology (Lehmann I); IUF - Leibniz Research Institute for Environmental Medicine, Duesseldorf (Schikowski T, Kraemer U); Department of Pediatrics, Technical University, Munich (Bauer CP, Hoffman U).

**HAPO:** would like to acknowledge the participants and research personnel at the participating HAPO field centres.

**The Helsinki Birth Cohort Study:** (HBCS/HBCS 1934-44) thanks Professor David Barker and Tom Forsen. The DNA extraction, sample quality control, biobank up-keep and aliquotting were performed at the National Institute for Health and Welfare, Helsinki, Finland.

**INMA:** The authors are grateful to Silvia Fochs, Anna Sánchez, Maribel López, Nuria Pey, Muriel Ferrer, Amparo Quiles, Sandra Pérez, Gemma León, Elena Romero, Maria Andreu, Nati Galiana, Maria Dolores Climent and Amparo Cases for their assistance in contacting the families and administering the questionnaires. The authors would particularly like to thank all the participants for their generous collaboration. A full roster of the INMA Project Investigators can be found at [http://www.proyectoinma.org/presentacion-inma/listado-investigadores/en\\_listado-investigadores.html](http://www.proyectoinma.org/presentacion-inma/listado-investigadores/en_listado-investigadores.html).

**Inter99 study:** We thank all participants and our committed staff.

**Leipzig-Childhood-Obesity:** We are grateful to all the patients and families for contributing to the study. We highly appreciate the support of the Obesity Team and Auxo Team of the Leipzig University Children's Hospital for management of the patients and to the Pediatric Research Center Lab Team for support with DNA banking.

**MoBa-2008 and MoBa-HARVEST:** We are grateful to all the participating families in Norway who take part in this ongoing cohort study. Researchers interested in using MoBa data must obtain approval from the Scientific Management Committee of MoBa and from the Regional



Committee for Medical and Health Research Ethics for access to data and biological material. Researchers are required to follow the terms of a Data or Material Transfer Agreement containing a number of clauses designed to ensure protection of privacy and compliance with relevant laws.

**NCCGP:** We thank all of the participants of the North Cumbria Community Genetics Project and previous members of the study team, in particular Professor Sir John Burn and Mrs Pat Jonas.

**NEO:** The authors thank all individuals who participated in the Netherlands Epidemiology in Obesity study, all participating general practitioners for inviting eligible participants and all research nurses for collection of the data. We thank the NEO study group and Ingeborg de Jonge for the coordination and data management of the NEO study. The genotyping in the NEO study was supported by the Centre National de GŽnotypage (Paris, France), headed by Jean-Francois Deleuze.

**NFBC 1966 and 1986:** We thank the late professor Paula Rantakallio (launch of NFBC1966), the participants in the 31- and 46-years-old study and the NFBC project center. We thank professor Anna-Liisa Hartikainen (launch of NFBC1986), the participants in the study and the NFBC project center.

**NTR:** The Netherlands Twin Register warmly thanks all participating twin families for their contributions. We would like to thank the Avera Human Genetics research lab for their close collaboration, DNA typing and sample logistics.

**ORCADES:** DNA extractions were performed at the Wellcome Trust Clinical Research Facility in Edinburgh. We would like to acknowledge the invaluable contributions of Lorraine Anderson and the research nurses in Orkney, the administrative team in Edinburgh and the people of Orkney.

**PANIC:** We are grateful to the children and their parents for participating in the PANIC study and to the whole research team for their contribution in carrying out the study.

**QIMR:** We thank Richard Parker, Soad Hancock, Judith Moir, Sally Rodda, Pieta-Maree Shertock, Heather Park, Jill Wood, Pam Barton, Fran Husband, Adele Somerville, Ann Eldridge, Marlene Grace, Kerrie McAloney, Anjali Henders, Lisa Bowdler, Alexandre Todorov, Steven Crooks, David Smyth, Harry Beeby, and Daniel Park. Finally, we thank the twins and their families for their participation.

**RAINE STUDY:** The authors are grateful to the Raine Study participants and their families, and to the Raine Study research staff for cohort coordination and data collection. The authors gratefully acknowledge the NH&MRC for their long term contribution to funding the study over the last 29 years and also the following Institutions for providing funding for Core Management of the Raine Study: The University of Western Australia (UWA), Raine Medical Research Foundation, UWA Faculty of Medicine, Dentistry and Health Sciences, The Telethon Kids Institute, Women and Infants Research Foundation, Curtin University, Edith Cowan University, Murdoch University, and the University of Notre Dame. The authors gratefully acknowledge the assistance of the Western Australian DNA Bank (National Health

and Medical Research Council of Australia National Enabling Facility). This work was supported by resources provided by the Pawsey Supercomputing Centre with funding from the Australian Government and the Government of Western Australia.

**Rhode Island Child Health Study (RICHS):** The authors are thankful for the study participants for their participation, and the study staff at Women and Infants Hospital for their dedication to the project.

**SCORM:** We thank all participants and our dedicated research staff led by Sister Peck Chye Fong.

**SKOT:** We specially want to express our thanks to the participant children and their parents that were part of the SKOT I and SKOT II studies.

**STRIP:** We thank the study participants and their families as well as the research group who collected the data.

**SWS:** We thank the mothers of the Southampton Women's Survey who gave us their time and acknowledge the work of the Southampton Women's Survey Study Group, and the team of dedicated research nurses and ancillary staff for their assistance.

**TDCOB:** The Danish Childhood Obesity Biobank would like to thank all children, youths, and their families for participation in the studies and thus providing opportunities to detect novel insights in regards to childhood obesity.

**TEENAGE:** We would like to thank all study participants and their families as well as all volunteers for their contribution in this study. We thank the following staff from the Sample Management and Genotyping Facilities at the Wellcome Trust Sanger Institute for sample preparation, quality control and genotyping: Dave Jones, Doug Simpkin, Emma Gray, Hannah Blackburn and Sarah Edkins.

**UK Biobank:** This study has been conducted using the UK Biobank Resource under Application Numbers 7036, 9161, 9905 and 12703. The authors would like to acknowledge the use of the University of Exeter High-Performance Computing (HPC) facility in carrying out this work.

**The Young Finns Study:** We thank the study participants and their families as well as the research group who collected the data.

**23andMe:** We thank the employees and participants of 23andMe for providing the full set of summary statistics from the published GWAS of gestational duration (Zhang et al. 2017 NEJM).

## **Supplementary Note 5: Funding and Support for Studies**

**1958 British Birth Cohort** acknowledges use of phenotype and genotype data from the British 1958 Birth Cohort DNA collection, funded by the Medical Research Council grant G0000934 and the Wellcome Trust grant 068545/Z/02. The management of the 1958 Birth Cohort is funded by the Economic and Social Research Council (grant number ES/M001660/1). Access to these resources was enabled via the 58READIE Project funded by Wellcome Trust and Medical Research Council (grant numbers WT095219MA and G1001799). Genotyping for the 1958BC-WTCCC subset was funded by the Wellcome Trust grant 076113/B/04/Z. The 1958BC -T1DGC genotyping utilised resources provided by the Type 1 Diabetes Genetics Consortium, a collaborative clinical study sponsored by the National Institute of Diabetes and Digestive and Kidney Diseases (NIDDK), National Institute of Allergy and Infectious Diseases (NIAID), National Human Genome Research Institute (NHGRI), National Institute of Child Health and Human Development (NICHD), and Juvenile Diabetes Research Foundation International (JDRF) and supported by U01 DK062418. 1958BC -T1DGC GWAS data were deposited by the Diabetes and Inflammation Laboratory, Cambridge Institute for Medical Research (CIMR), University of Cambridge, which is funded by Juvenile Diabetes Research Foundation International, the Wellcome Trust and the National Institute for Health Research Cambridge Biomedical Research Centre; the CIMR is in receipt of a Wellcome Trust Strategic Award (079895). The 1958BC -GABRIEL genotyping was supported by a contract from the European Commission Framework Programme 6 (018996) and grants from the French Ministry of Research. Statistical analyses were funded by the Academy of Finland (Project 24300796 and SALVE/PREVMEDSYN). Great Ormond Street Hospital/University College London, Institute of Child Health receives a proportion of funding from the Department of Health's National Institute for Health Research (NIHR) ('Biomedical Research Centres' funding).

The **ABCD** study has been supported by grants from the Netherlands Organisation for Health Research and Development (ZonMW) and The Netherlands Heart Foundation. Genotyping was funded by the BBMRI-NL grant CP2013-50.

**ALSPAC:** The work undertaken in this paper was funded by the ERC (Grant number 669545; DevelopObese), US National Institute of Diabetes and Digestive and Kidney Diseases (R01 DK10324) and the Wellcome Trust (WT088806), with the WT088806 grant also providing funds for completion of genome wide genotyping on the ALSPAC mothers. ALSPAC offspring GWAS data was generated by Sample Logistics and Genotyping Facilities at the Wellcome Trust Sanger Institute and LabCorp (Laboratory Corporation of America) using support from 23andMe. Additional maternal data were funded by the British Heart Foundation (SP/07/008/24066) and WellcomeTrust (WT087997). The UK Medical Research Council and Wellcome Trust (Grant ref: 102215/2/13/2) and the University of Bristol provide core support for ALSPAC. The views expressed in this publication are those of the authors and not necessarily those of the UK NHS, the National Institute for Health Research or the Department of Health, or any other funders who have supported the work. None of the funders influenced the study design, data collection, analysis or interpretation of results, or the decision to submit the paper for publication

**Barcelona Supercomputing Center:** This work has been sponsored by the grant SEV-2011-00067 of Severo Ochoa Program, awarded by the Spanish Government. This work was supported by an EFSD/Lilly research fellowship.

**BBC:** The Berlin Birth Cohort study was funded by the Deutsche Forschungsgemeinschaft (DFG), Else Kršner-Fresenius Foundation, Jackstšdt-Foundation and a research grant of the University of Potsdam, Germany. Details of the study are provided in: *Pharmacogenet Genomics*. 2009;19(9):710-8.; *Circulation*. 2006 Oct 17;114(16):1687-92 and *Lancet*. 2000 Apr 8;355(9211):1241-2. We deeply acknowledge the contribution of the participating families. Genotyping and analyses were supported by Wellcome Trust (grant numbers WT064890, WT090532, WT098381) and Framework VII: ENGAGE (HEALTH-F4-2007-201413).

**CHOP** was financially supported by an Institute Development Award from the Children's Hospital of Philadelphia, a Research Development Award from the Cotswold Foundation, NIH grant R01 HD056465 and the Daniel B. Burke Endowed Chair for Diabetes Research (SFAG).

**CLHNS** was supported by National Institutes of Health grants DK078150, TW05596 and HL085144 and pilot funds from RR20649, ES10126, and DK056350.

The **CoLaus** study was and is supported by research grants from GlaxoSmithKline, the Faculty of Biology and Medicine of Lausanne, and the Swiss National Science Foundation (grants 33CS0-122661, 33CS30-139468 and 33CS30-148401).

**COPSACs** greatly acknowledge the private and public research funding allocated to COPSAC and listed on [www.copsac.com](http://www.copsac.com), with special thanks to The Lundbeck Foundation; Ministry of Health; Danish Council for Strategic Research; The Danish Council for Independent Research and The Capital Region Research Foundation as core supporters. The Danish Pediatric Asthma Centre provided the core support for COPSAC research center. This project has received funding from the European Union's Horizon 2020 research and innovation programme under grant agreement No 667191. The funding agencies did not have any influence on study design, data collection and analysis, decision to publish or preparation of the manuscript. No pharmaceutical company was involved in the study.

**DNBC:** The Danish National Research Foundation has established the Danish Epidemiology Science Centre that initiated and created the Danish National Birth Cohort (DNBC). The cohort is furthermore a result of a major grant from this foundation. Additional support for the Danish National Birth Cohort is obtained from the Pharmacy Foundation, the Egmont Foundation, the March of Dimes Birth Defects Foundation, the Augustinus Foundation, and the Health Foundation. The DNBC 7-year follow-up is supported by the Lundbeck Foundation (195/04) and the Danish Medical Research Council (SSVF 0646). The DNBC biobank is a part of the Danish National Biobank resource, which is supported by the Novo Nordisk Foundation.

**DNBC preterm:** The DNBC preterm study is a nested study within the DNBC. The generation of GWAS genotype data for the DNBC preterm sample was carried out within the Gene

Environment Association Studies (GENEVA) consortium with funding provided through the National Institutes of Health's Genes, Environment, and Health Initiative (U01HG004423; U01HG004446; U01HG004438).

**DNBC-GOYA:** GOYA is a nested study within the DNBC, and conducted in collaboration with the MRC Integrative Epidemiology Unit at the University of Bristol (MC\_UU\_12013/1-9). The genotyping for DNBC-GOYA study was funded by the Wellcome Trust (WT 084762). The GOYA-offspring study is a nested study within the DNBC-GOYA study. The genotyping of the GOYA-offspring has been financed by the Novo Nordisk Foundation Center for Basic Metabolic Research.

**EFSOCH:** The Exeter Family Study of Childhood Health (EFSOCH) was supported by South West NHS Research and Development, Exeter NHS Research and Development, the Darlington Trust and the Peninsula National Institute of Health Research (NIHR) Clinical Research Facility at the University of Exeter. The views expressed are those of the authors and not necessarily those of NIHR, the NHS or the Department of Health. Genotyping of the EFSOCH study samples was funded by the Wellcome Trust and Royal Society grant WT104150.

**EPIC-Norfolk** is supported by Cancer Research UK (SP2024-0201 and SP2024-0204) and the Medical Research Council (G9502233).

The **ERF** study as a part of EUROSPAN (European Special Populations Research Network) was supported by European Commission FP6 STRP grant number 018947 (LSHG-CT-2006-01947) and also received funding from the European Community's Seventh Framework Programme (FP7/2007-2013)/grant agreement HEALTH-F4-2007-201413 by the European Commission under the programme "Quality of Life and Management of the Living Resources" of 5th Framework Programme (no. QLG2-CT-2002-01254). The ERF study was further supported by ENGAGE consortium and Center for Medical Systems Biology (CMSB). High-throughput analysis of the ERF data was supported by joint grant from Netherlands Organisation for Scientific Research and the Russian Foundation for Basic Research (NWO-RFBR 047.017.043).

The **Fenland** Study is funded by the Medical Research Council (MC\_U106179471) and Wellcome Trust.

**FHS:** The FHS phenotype-genotype analyses were supported by the National Institute of Aging (R56AG29451). This research was conducted in part using data and resources from the Framingham Heart Study of the National Heart Lung and Blood Institute of the National Institutes of Health and Boston University School of Medicine. The analyses reflect intellectual input and resource development from the Framingham Heart Study investigators participating in the SNP Health Association Resource (SHARe) project. This work was partially supported by the National Heart, Lung and Blood Institute's Framingham Heart Study (Contract No. N01-HC-25195, HHSN268201500001) and its contract with Affymetrix, Inc for genotyping services (Contract No. N02-HL-6-4278). The authors are pleased to acknowledge that the computational work reported on in this paper was

performed on the Shared Computing Cluster which is administered by Boston University's Research Computing Services. URL: [www.bu.edu/tech/support/research/](http://www.bu.edu/tech/support/research/).

**Gen-3G:** The Gen3G prospective cohort was supported by the Fonds de Recherche du Québec – Santé (FRQS - subvention Fonctionnement - Recherche Clinique - grant #20697) and by a Canadian Institute of Health Research (CIHR) Operating grant (Institute of Nutrition, Metabolism and Diabetes; MOP- 115071).

**Generation R:** The general design of Generation R Study is made possible by financial support from Erasmus MC, Rotterdam, Erasmus University Rotterdam, the Netherlands Organization for Health Research and Development (ZonMw), the Netherlands Organisation for Scientific Research (NWO), the Ministry of Health, Welfare and Sport and the Ministry of Youth and Families. This project also received funding from the European Union's Horizon 2020 research and innovation programme under grant agreements No 633595 (DynaHEALTH) and No 733206 (LIFECYCLE), from the European Research Council (ERC Consolidator Grant, ERC-2014-CoG-648916 to V.W.V.J.) and from the Netherlands Organisation for Health Research and Development (VIDI 016. 136. 361 to V.W.V.J.).

**HAPO:** This study was supported by National Institutes of Health (NIH) grants (HD34242, HD34243, HG004415, DK097534 and DK099820) and by the American Diabetes Association.

**HBCS:** received financial support from the Academy of Finland (project grants 120315, 129287, 218029 and 267561).

The **Health2006** was financially supported by grants from the Velux Foundation; The Danish Medical Research Council, Danish Agency for Science, Technology and Innovation; The Aase and Ejner Danielsen's Foundation; ALK-Abello A/S, Hørsholm, Denmark, and Research Centre for Prevention and Health, the Capital Region of Denmark.

**INMA:** This study was funded by grants from Instituto de Salud Carlos III (CB06/02/0041, FIS PI041436, PI081151, PI041705, PS09/00432, FIS-FEDER 03/1615, 04/1509, 04/1112, 04/1931, 05/1079, 05/1052, 06/1213, 07/0314, 09/02647, PI06/0867, PI09/0009), Spanish Ministry of Science and Innovation (SAF2013-49108-R), European Commission (ENGAGE project and grant agreement HEALTH-F4-2007-201413), Fundació La Marató de TV3, Generalitat de Catalunya-CIRIT AGAUR 2014 SGR-1138, Conselleria de Sanitat Generalitat Valenciana, Departamento de Sanidad del Gobierno Vasco (110093/2005, 110669/2009), Diputación Foral de Gipuzkoa (DFG 05/007, DFG06/004, DFG08/001), Ayuntamiento de la Zona del estudio (Azpeitia, Azkoitia, Beasain, Zumarraga, Legazpia, Urretxu). Part of the DNA extractions and genotyping was performed at the Spanish National Genotyping Centre (CEGEN-Barcelona).

**Inter99:** The study was financially supported by research grants from the Danish Research Council, the Danish Centre for Health Technology Assessment, Novo Nordisk Inc., Research Foundation of Copenhagen County, Ministry of Internal Affairs and Health, the Danish Heart Foundation, the Danish Pharmaceutical Association, the Augustinus Foundation, the Ib Henriksen Foundation, the Becket Foundation, and the Danish Diabetes Association.

The **Novo Nordisk Foundation Center** for Basic Metabolic Research, an independent Research Center at the University of Copenhagen, partially funded by an unrestricted donation from the Novo Nordisk Foundation ([www.metabol.ku.dk](http://www.metabol.ku.dk)).

**Leipzig-Childhood-Obesity** was supported by grants from Integrated Research and Treatment Center (IFB) Adiposity Diseases 01EO1001, from the German Research Foundation for the Collaborative Research Center CRC1085 "Atherobesity" project C05, and by the European Commission (Beta-JUDO n<sup>o</sup> 279153).

**MoBa-2008 and MoBa-HARVEST:** This work was supported by grants from the Norwegian Research Council (FUGE 183220/S10, FRIMEDKLI-05 ES236011), Swedish Medical Society (SLS 2008- 21198), Jane and Dan Olsson Foundations and Swedish government grants to researchers in the public health service (ALFGBG-2863, ALFGBG-11522), and the European Community's Seventh Framework Programme (FP7/2007-2013), ENGAGE Consortium, grant agreement HEALTH-F4-2007-201413. The Norwegian Mother and Child Cohort Study was also supported by grants from the European Research Council (AdG #293574), the Bergen Research Foundation ("Utilizing the Mother and Child Cohort and the Medical Birth Registry for Better Health"), Stiftelsen Kristian Gerhard Jebsen (Translational Medical Center), the University of Bergen, the Research Council of Norway (FRIPRO grant #240413), the Western Norway Regional Health Authority (Strategic Fund "Personalized Medicine for Children and Adults", and Open Grants («Understanding infant weight biology through genomics and deep phenotyping» grant #912250), and the Norwegian Diabetes Foundation; the Research Council of Norway through its Centres of Excellence funding scheme (#262700), Better Health by Harvesting Biobanks (#229624) and The Swedish Research Council, Stockholm, Sweden (2015-02559), The Research Council of Norway, Oslo, Norway (FRIMEDBIO ES547711, March of Dimes (#21-FY16-121). The Norwegian Mother and Child Cohort Study is supported by the Norwegian Ministry of Health and Care Services and the Ministry of Education and Research, NIH/NIEHS (contract no N01-ES-75558), NIH/NINDS (grant no.1 U01 NS 047537-01 and grant no.2 U01 NS 047537-06A1).

**NCCGP:** Funding for the initial setup and maintenance of the NCCGP resource was provided by British Nuclear Fuels plc and orchestrated by the NCCGP management team and staff at Westlakes Research Institute. Subsequent funding for its continued storage and maintenance has been provided from a number of sources, largely project grants utilising samples from the collection.

The **NEO** study is supported by the participating Departments, the Division and the Board of Directors of the Leiden University Medical Center, and by the Leiden University, Research Profile Area Vascular and Regenerative Medicine.

The **Northern Finland Birth Cohort (NFBC)** 1966 and 1986 studies have received financial support from the Academy of Finland (project grants 104781, 120315, 129269, 1114194, 24300796, Center of Excellence in Complex Disease Genetics and SALVE), University Hospital Oulu, Biocenter, University of Oulu, Finland (75617), NIHM (MH063706, Smalley and Jarvelin), Juselius Foundation, NHLBI grant 5R01HL087679-02 through the STAMPEED program (1RL1MH083268-01), NIH/NIMH (5R01MH63706:02), the European Commission (EURO-BLCS, Framework 5 award QL1-CT-2000-01643), ENGAGE project and grant

agreement HEALTH-F4-2007-201413, EU FP7 EurHEALTHAgeing -277849, the Medical Research Council, UK (G0500539, G0600705, G1002319, PrevMetSyn/SALVE) and the MRC, Centenary Early Career Award. The program is currently being funded by the H2020 DynaHEALTH action (grant agreement 633595) and academy of Finland EGEA-project (285547). The DNA extractions, sample quality controls, biobank up-keeping and aliquotting was performed in the National Public Health Institute, Biomedicum Helsinki, Finland and supported financially by the Academy of Finland and Biocentrum Helsinki. We thank the late Professor Paula Rantakallio (launch of NFBCs), and Ms Outi Tornwall and Ms Minttu Jussila (DNA biobanking). The authors would like to acknowledge the contribution of the late Academician of Science Leena Peltonen.

**NTR** obtained funding from the Netherlands Organization for Scientific Research (NWO: MagW/ZonMW grants 916-76-125, 904-61-090, 985-10-002, 904-61-193, 480-04-004, 400-05-717, 481-08-011, 451-04-034, 463-06-001, 912-10-020, Addiction- 31160008 Middelgroot-911-09-032, Spinozapremie 56-464-14192), NWO-Groot 480-15-001/674: Netherlands Twin Registry Repository, Biobanking and Biomolecular Resources Research Infrastructure (BBMRI-NL, 184.021.007; 184.033.111 ), Amsterdam Public Health (APH), the European Community's Seventh Framework Program (FP7/2007- 2013), ENGAGE (HEALTH-F4-2007-201413); the European Research Council (ERC Advanced, 230374), the Avera Institute Human Genetics (AIHG) Rutgers University Cell and DNA Repository (National Institute of Mental Health (NIMH) U24 MH068457-06), and the National Institutes of Health (NIH, R01D0042157-01A; 1RC2MH089995-01; R01DK092127-01). Part of the genotyping and analyses were funded by the Genetic Association Information Network (GAIN) of the Foundation for the US National Institutes of Health, and by grants from GAIN and the NIMH (MH081802).

**ORCADES** was supported by the Chief Scientist Office of the Scottish Government (CZB/4/276 and CZB/4/710), the Royal Society, the MRC Human Genetics Unit, Arthritis Research UK and the European Union framework program 6 EUROSPAN project (contract no. LSHG-CT-2006-018947).

**University of Oxford**, UK, was funded by the British Heart Foundation (grant code SP/13/2/30111), the European Commission (ENGAGE: HEALTH-F4-2007-201413), Medical Research Council (G0601261), and the Wellcome Trust (090532, 098381).

The PANIC study has been financially supported by grants from Ministry of Social Affairs and Health of Finland, Ministry of Education and Culture of Finland, Finnish Innovation Fund Sitra, Social Insurance Institution of Finland, Finnish Cultural Foundation, Juho Vainio Foundation, Foundation for Paediatric Research, Paavo Nurmi Foundation, Yrjö Jahnesson Foundation, Diabetes Research Foundation in Finland, Finnish Foundation for Cardiovascular Research, Research Committee of the Kuopio University Hospital Catchment Area (State Research Funding), Kuopio University Hospital (EVO funding number 5031343) and the city of Kuopio.

**QIMR:** Supported by National Institutes of Health Grants AA07535, AA07580, AA07728, AA10249, AA13320, AA13321, AA14041, AA11998, AA17688, DA012854, DA018267, DA018660, DA23668 and DA019951; by Grants from the Australian National Health and



Medical Research Council (241944, 339462, 389927, 389875, 389891, 389892, 389938, 442915, 442981, 496739, 552485, 552498, and 628911); by Grants from the Australian Research Council (A7960034, A79906588, A79801419, DP0770096, DP0212016, and DP0343921); and by the 5th Framework Programme (FP-5) GenomEUtwin Project (QLG2-CT-2002-01254).

**RAINE** study was supported by the Raine Medical Research Foundation, National Health and Medical Research Council of Australia (NHMRC grant numbers 572613, 403981 and 003209) and the Canadian Institutes of Health Research (CIHR grant number MOP-82893).

**RHEA:** The Rhea study was financially supported by European projects (EU FP6-2003-Food-3-NewGeneris, EU FP6. STREP Hiwate, EU FP7 ENV.2007.1.2.2.2. Project No 211250 Escape, EU FP7-2008-ENV-1.2.1.4 Envirogenomarkers, EU FP7-HEALTH-2009- single stage CHICOS, EU FP7 ENV.2008.1.2.1.6. Proposal No 226285 ENRIECO, EU- FP7- HEALTH-2012 Proposal No 308333 HELIX), MeDALL (FP7 European Union project, No. 264357), and the Greek Ministry of Health (Program of Prevention of obesity and neurodevelopmental disorders in preschool children, in Heraklion district, Crete, Greece: 2011-2014; Òrhea PlusÓ: Primary Prevention Program of Environmental Risk Factors for Reproductive Health, and Child Health: 2012-15).

The Rhode Island Child Health Study (RICHS) is partially supported by NIH-NIEHS R01ES022223, NIH-NIEHS R01ES022223-03S1, and NIH-NIEHS R24ES028507.

**SCORM** was funded by National Medical Research Foundation, Singapore (NMRC/0975/2005) and Biomedical Research Council, Singapore (BMRC 06/1/21/19/466).

The **SKOT** studies were supported by grants from The Danish Directorate for Food, Fisheries and Agri Business as part of the 'Complementary and young child feeding (CYCF) – impact on short- and long-term development and health' project. This project was carried out as part of the research programme "Governing Obesity" funded by the University of Copenhagen Excellence Programme for Interdisciplinary Research ([www.go.ku.dk](http://www.go.ku.dk))

**SORBS:** This work was supported by the Integrated Research and Treatment Center (IFB) AdiposityDiseases (K403, K737, AD2-7123, AD2-06E95, AD2-06E99). IFB is supported by the Federal Ministry of Education and Research (BMBF), Germany FKZ: 01EO1501. This project was further supported by the German Research Foundation (CRC 1052 "Obesity mechanisms", A01 and B03; SPP 1629 TO 718/2-1) and by the German Diabetes Association.

**STRIP** was supported by Academy of Finland (grants 206374, 251360 and 276861); Juho Vainio Foundation; Finnish Cardiac Research Foundation; Finnish Cultural Foundation; Finnish Ministry of Education and Culture; Sigrid Juselius Foundation; Yrjö Jahnesson Foundation; C.G. Sundell Foundation; Special Governmental Grants for Health Sciences Research, Turku University Hospital; Foundation for Pediatric Research; and Turku University Foundation.

**SWS Mothers:** This work was supported by grants from the Medical Research Council, Dunhill Medical Trust, National Institute for Health Research Southampton Biomedical Research Centre, University of Southampton and University Hospital Southampton National

Health Service Foundation Trust, and the European Union's Seventh Framework Programme (FP7/2007-2013), project EarlyNutrition (grant 289346).

**TDCOB** received supports from the Danish Innovation Foundation and The Region Zealand Health and Medical Research Foundation. This study was partly supported by grants from the Program Committee for Individuals, Disease and Society of the Danish Innovation Foundation (grant numbers: 0603-00484B and 0603-00457B) and was part of the research activities in The Impact of our Genomes on Individual Treatment Response in Obese Children (TARGET, [www.target.ku.dk](http://www.target.ku.dk)) and the Indo-Danish bi-lateral project, Genetics and Systems Biology of Childhood Obesity in India and Denmark (BioChild, [www.biochild.ku.dk](http://www.biochild.ku.dk)).

**TEENAGE** study has been co-financed by the European Union (European Social Fund (ESF)) and Greek national funds through the Operational Program “Education and Lifelong Learning” of the National Strategic Reference Framework (NSRF)-Research Funding Program: Heracleitus II. Investing in knowledge society through the European Social Fund. This work was funded by the Wellcome Trust (098051).

**TwinsUK:** The study was funded by the Wellcome Trust; European Community's Seventh Framework Programme (FP7/2007-2013). The study also receives support from the National Institute for Health Research (NIHR)- funded BioResource, Clinical Research Facility and Biomedical Research Centre based at Guy's and St Thomas' NHS Foundation Trust in partnership with King's College London. Tim Spector is holder of an ERC Advanced Principal Investigator award. SNP Genotyping was performed by The Wellcome Trust Sanger Institute and National Eye Institute via NIH/CIDR.

The **Young Finns Study** has been financially supported by the Academy of Finland: grants 286284, 134309 (Eye), 126925, 121584, 124282, 129378 (Salve), 117787 (Gendi), and 41071 (Skidi); the Social Insurance Institution of Finland; Competitive State Research Financing of the Expert Responsibility area of Kuopio, Tampere and Turku University Hospitals (grant X51001); Juho Vainio Foundation; Paavo Nurmi Foundation; Finnish Foundation for Cardiovascular Research ; Finnish Cultural Foundation; The Sigrid Juselius Foundation; Tampere Tuberculosis Foundation; Emil Aaltonen Foundation; Yrjö Jahnsson Foundation; Signe and Ane Gyllenberg Foundation; Diabetes Research Foundation of Finnish Diabetes Association; and EU Horizon 2020 (grant 755320 for TAXINOMISIS); and European Research Council (grant 742927 for MULTIEPIGEN project); Tampere University Hospital Supporting Foundation.

## **Supplementary Note 6: Authors' funding acknowledgements**

N.M.W. is supported by an Australian National Health and Medical Research Council Early Career Fellowship (APP1104818); R.M.F. and R.N.B. are supported by Sir Henry Dale Fellowship (Wellcome Trust and Royal Society grant: WT104150); K.H. is partially supported by National Natural Science Foundation of China (Grant No. 91643201, 21876134), and by Ministry of Science and Technology of China (Grant No. 2016YFC0206507); B.F. is supported by Novo Nordisk Foundation (12955) and an Oak Foundation Fellowship; T.M.F. and A.R.W. are supported by the European Research Council grant: 323195 SZ-245 50371-GLUCOSEGENES-FP7-IDEAS-ERC; J.T. is funded by the European Regional Development Fund (ERDF), the European Social Fund (ESF), Convergence Programme for Cornwall and the Isles of Scilly and the Diabetes Research and Wellness Foundation Non-Clinical Fellowship; G-H.M. has a PhD grant from the South-Eastern Norway Regional Health Authority (Grant number 2015008); M.H.Z. was supported by BBMRI-NL (CP2013-50); The Novo Nordisk Foundation Center for Basic Metabolic Research is an independent Research Center at the University of Copenhagen partially funded by an unrestricted donation from the Novo Nordisk Foundation ([www.metabol.ku.dk](http://www.metabol.ku.dk)); T.S.A. was partially funded by the Gene-Diet Interactions in Obesity (GENDINO) project on behalf of GOYA male cohort data management and analyses and acknowledges the same; L.P. was supported by the UK Medical Research Council Unit grants MC\_UU\_12013/4; D.L.C. is funded by the American Diabetes Association Grant 1-17-PDF-077; N.V-T. is funded by a pre-doctoral grant from the Agència de Gestió d'Ajuts Universitaris i de Recerca (AGAUR) (2015 FI\_B 00636), Generalitat de Catalunya; V.L. was funded in part through the European Union's Seventh Framework Programme (FP7/2007-2013), ENGAGE project, grant agreement HEALTH-F4-2007-201413 and by fellowship from the FWO; R.C.R. is supported by CRUK (grant number C18281/A19169); H.M.I. works within the MRC Lifecourse Epidemiology Unit at the University of Southampton (MC\_UU\_12011/4); X.E. was supported by Agència de Gestió d'Ajuts Universitaris i de Recerca (AGAUR, Generalitat de Catalunya); L.M. was supported by the 2010-2011 PRIN funds of the University of Ferrara - Holder: Prof. Guido Barbujani, Supervisor: Prof. Chiara Scapoli - and in part sponsored by the European Foundation for the Study of Diabetes (EFSD) Albert Renold Travel Fellowships for Young Scientists, 05 per mille contribution assigned to the University of Ferrara, income tax return year 2009 and the ENGAGE Exchange and Mobility Program for ENGAGE training funds, ENGAGE project, grant agreement HEALTH-F4-2007-201413; J.M. Murabito was funded by National Institute on Aging (R01AG29451); C.L.R. was supported by the US National Institute of Health (grant: R01 DK10324), UK Medical Research Council Unit grants MC\_UU\_12013\_5, and ESRC (RES-060-23-0011); C.A. is a member of the FRQS-funded Centre de recherche du CHUS (affiliated to the Centre hospitalier universitaire de Sherbrooke); L.B. is a junior research scholar from the Fonds de la recherche du Québec – santé (FRQS), and a member of the FRQS-funded Centre de recherche du CHUS (affiliated to the Centre hospitalier universitaire de Sherbrooke). L.B. was funded over the years by Diabète Québec, the FRQS and the Canadian Institutes of Health Research; M-F.H. is currently supported by an American Diabetes Association (ADA) Pathway Program Accelerator Early Investigator Award (1-15-ACE-26); G.Z. is supported by the Burroughs Wellcome Fund Preterm Birth Research Grant (#1017289); L.J.M. was supported by the March of Dimes Prematurity Research Center Ohio Collaborative; G.H. works within the MRC Integrative Epidemiology Unit at the University of Bristol (MC\_UU\_12013/1-9); S.M.R. was supported by the UK Medical Research Council Unit

grants MC\_UU\_12013\_5; S.D. was supported by National Institute of Health Research; S.B-G. was supported by FI-DGR Fellowship from FIDGR 2013 from Agència de Gestió d'Ajuts Universitaris i de Recerca (AGAUR, Generalitat de Catalunya); J.M.Mercader was supported by Sara Borrell Fellowship from the Instituto Carlos III and Beatriu de Pinós fellowship from the Agency for Management of University and Research Grants (AGAUR); S.E.M. was funded by an NHMRC Senior Research Fellowship (APP1103623); K.Panoutsopoulou is funded by a career development fellowship (grant 20308) and by the Wellcome Trust (WT098051); M.B. is supported by an ERC consolidator grant (ERC-2017-COG 771057 WELL-BEING); I.P. was funded in part by the Wellcome Trust (WT205915), the European Union's Horizon 2020 research, the European Union FP7-IDEAS-ERC Advanced Grant (GEPIDIAB, ERC-AG – ERC-294785), and innovation programme (DYNAhealth, H2020-PHC-2014-633595); M.A.T. is supported by a Wellcome Trust Institutional Strategic Support Award (WT097835MF); H.Y. is funded by Diabetes UK RD Lawrence fellowship (grant: 17/0005594); M.N.W. and S.E.J. are funded by the Medical Research Council (grant: MR/M005070/1); E.Z. is supported by the Wellcome Trust (098051); G.W.M was supported by the Australian NHMRC Fellowships Scheme (619667); J.F.W. is supported by the MRC Human Genetics Unit quinquennial programme "QTL in Health and Disease"; T.G.M.V was supported by ZonMW (TOP 40–00812–98–11010); H.N.K. is awarded EU-FP7 Marie Curie Actions - Career Integration Grant (CIG-293511); A.T.H. is supported by the Wellcome Trust Senior Investigator Awards (WT098395) and the National Institute for Health Research (NIHR) Senior Investigator Award (NF-SI-0611-10219); D.I.B. is supported by Spinozapremie (NWO-56-464-14192) and the Royal Netherlands Academy of Science Professor Award (PAH/6635) to DIB; S.S. and M-R.J. have received funding from the European Union's Horizon 2020 research and innovation programme [under grant agreement No 633595] for the DynaHEALTH action; P.V. received funding from the Swiss National Science Foundation (grants 33CSCO-122661, 33CS30-139468 and 33CS30-148401), GlaxoSmithKline and the Faculty of Biology and Medicine of Lausanne, Switzerland; D.O.M-K. was supported by Dutch Science Organization (ZonMW-VENI Grant 916.14.023); J.F.F. received funding from the European Union's Horizon 2020 research and innovation programme under grant agreement No 633595 (DynaHEALTH) and 733206 (LifeCycle); V.W.V.J. received an additional grant from the Netherlands Organization for Health Research and Development (NWO, ZonMw-VIDI 016.136.361), a European Research Council Consolidator Grant (ERC-2014-CoG-648916) and funding from the European Union's Horizon 2020 research and innovation programme under grant agreement No 633595 (DynaHEALTH) and 733206 (LifeCycle); C.Pisinger is funded by the Health Foundation (Helsefonden); C.Power at UCL Institute of Child Health, with support from the National Institute for Health Research Biomedical Research Centre at Great Ormond Street Hospital for Children NHS Foundation Trust and University College London; G.D.S. works within the MRC Integrative Epidemiology Unit at the University of Bristol (MC\_UU\_12013/1); N.J.T. is a Wellcome Trust Investigator (202802/Z/16/Z), is the PI of the Avon Longitudinal Study of Parents and Children (MRC & WT 102215/2/13/2), is supported by the University of Bristol NIHR Biomedical Research Centre (BRC) and works within the CRUK Integrative Cancer Epidemiology Programme (C18281/A19169); H.H. is funded by The Children's Hospital of Philadelphia Endowed Chair in Genomic Research; S.F.A.G. is funded by the Daniel B. Burke Endowed Chair for Diabetes Research and R01 HD056465; D.A.L was supported by the European Research Council under the European Union's Seventh Framework Programme (FP/2007-2013) / ERC Grant Agreement (Grant number 669545; DevelopObese), US National Institute of Health (grant: R01 DK10324), the UK Medical

Research Council (grant: MC\_UU\_00011/6), Wellcome Trust GWAS grant (WT088806), an NIHR Senior Investigator Award (NF-SI-0611-10196) and the NIHR Biomedical Research Centre at University Hospitals Bristol NHS Foundation Trust and the University of Bristol; P.R.N. was supported by the European Research Council (AdG #293574), the Bergen Research Foundation (“Utilizing the Mother and Child Cohort and the Medical Birth Registry for Better Health”), Stiftelsen Kristian Gerhard Jebsen (Translational Medical Center), the University of Bergen, the Research Council of Norway (FRIPRO grant #240413), the Western Norway Regional Health Authority (Strategic Fund “Personalized Medicine for Children and Adults”, and Open Grants #25712 and #911879), and the Norwegian Diabetes Foundation; S.J. is supported by Helse Vest no. 23929, Bergen Forskningsstiftelse and KG Jebsen Foundation and University of Bergen; M.I.M. is a Wellcome Senior Investigator and NIHR Senior Investigator supported by the Wellcome (098381, 212259/Z/18/Z, 090532, 106130, 203141), EU (HEALTH-F4-2007-201413), NIH (U01-DK105535) and NIHR (NF-SI-0617-10090). This research/study/project was supported by the NIHR Oxford Biomedical Research Centre. The views expressed are those of the authors and not necessarily those of the NHS, the NIHR or the Department of Health; D.M.E. and this work were funded by the UK Medical Research Council Unit grant MC\_UU\_12013\_4, Australian Research Council Future Fellowship (FT130101709), a NHMRC Senior Research Fellowship (GNT1137714) and NHMRC project grants (GNT1125200, GNT1157714).